

Malikk

BYE BOLO  
BACCHOOO...



# INCOME TAX FASTTRACK BOOK

CA / CMA INTER | NEW SYLLABUS

For May/Nov 24 and June/Dec 24 exams

BY: CA. CS. VIJAY SARDA

BUSINESS

Bachoo

TAX  
PLANNING

IT DEPT

Returns

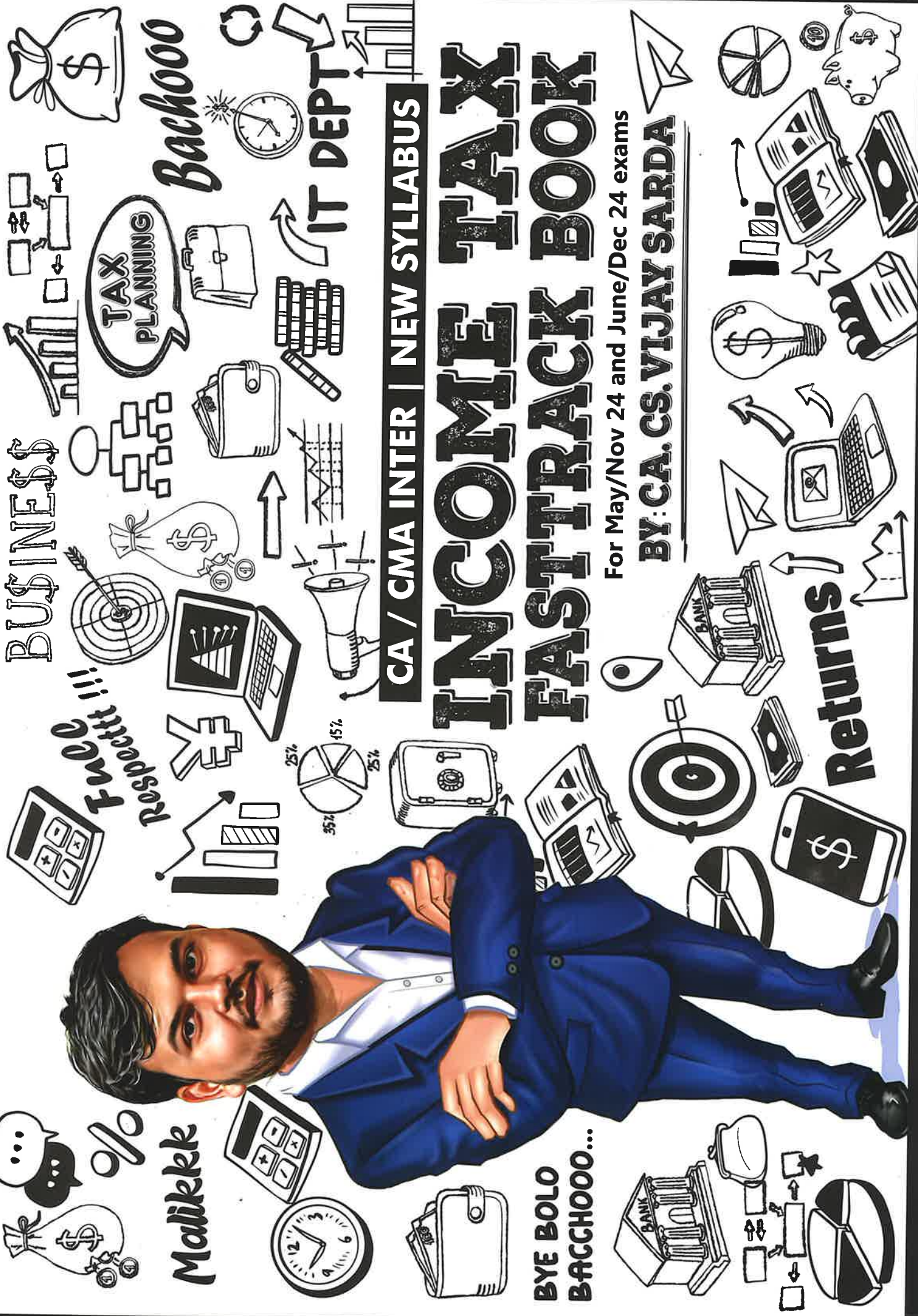





About Author

## CA. CS. Vijay Sarda

- ▶ Most Dynamic & Dedicated Faculty of Direct Tax, SM, Economics.
- ▶ Most preferred faculty for CA Inter & CA Final Direct Tax.
- ▶ Provides Interactive classes & Colour Notes, Charts, Questionnaire
- ▶ Teaching Experience 10+ years.
- ▶ Taught more than 1,00,000 Students.
- ▶ Member of ICAI & qualified Company secretary.
- ▶ Tax Consultant of big Export / Import Companies.
- ▶ 1st choice of CA Inter Students for Income Tax classes

Published by  
**SHREE PUBLICATIONS**



Distributed by  
**VLEARN CLASSES & EKATVAM ACADEMY**



About Co-author

## CA. Pallavi Sarda

- ▶ Chartered Accountant & Author to many Books for CA & CM
- ▶ Founder of Vlearn Classes & Shree Publications.
- ▶ Passionate about Arts & Cooking as a Hobby.
- ▶ Always an Exemption Holder in DT & IDT at all professional exams.
- ▶ Topper in Academics and Cultural Activities.

Every effort has been made to avoid errors or omissions in this publication. In spite of this errors may occur. Any mistake, error or discrepancy noted may be brought to our notice which shall be taken care of in PDF copy of that page will be published on telegram <https://t.me/cavjaysarda>. Also it will be taken care of in the next edition.

It is notified that neither the publisher nor the author or seller will be responsible for any damage or loss of action to any one, of any kind, in any manner, therefrom. It is suggested that to avoid any doubt the reader should cross-check all the facts, law and contents of the publication with original Government publication or notifications.









No part of this book may be reproduced or copied in any form or by any means [graphic, electronic or mechanical, including photocopying, Recording, Taping, or information retrieval systems] or reproduced on any Disc, Tape, Perforated media or other information storage device, etc., without the written permission of the publisher. Breach of this condition is liable for legal action.

For binding mistake, misprints or for missing pages, etc., the publisher liability is to replacement within one month of purchase by similar edition. All expenses in this connection are to be borne by the purchaser.

All disputes are subject to Pune jurisdiction only.

Disclaimer: all the images and maps are for demonstrative purpose only they do not represent any real place or person or so forth.

## CA NOTES COMMUNITY NETWORK

Click on Icon	QR CODE	LINK
 <p>Join what's App group</p>		<a href="#">CLICK HERE</a>
 <p>Join Telegram Channel</p>		<a href="#">CLICK HERE</a>
 <p>Subscribe On Youtube</p>		<a href="#">CLICK HERE</a>
 <p>Follow us On Instagram</p>		<a href="#">CLICK HERE</a>

**BE A PART OF CNC FAMILY**

**CNC – CA NOTES COMMUNITY**

**Mail at (for complaints/feedback) – [canotescommunity@gmail.com](mailto:canotescommunity@gmail.com)**

THANK YOU

TEAM CNC



## Dear Students,

It gives us immense pleasure to present before you a Comprehensive book on Direct Taxes. This book would not have been a reality but from the tremendous support from “My Love- Pallavi.

Special Thanks to **Ekatvam Team**, who has been involved “day & night literally” to fulfill this dream book without whom this would not have been the light of the day.

I Have been blessed to have an extraordinary support terms of colleagues, friends & family who have helped me in every sphere of my journey called this life. All these people deserve much more than a deep thank and love. I express all my gratitude to each and everyone of them for assisting me in all my endeavors. Thanks to the student community: For inviting me into your academics & making me your teacher. I am grateful for the opportunity to be of service to you. The love & affection you have shown is immense & invaluable. “Padho toh Hadh kardo warna Program radh kardo”

I express my respect, love and gratitude to **my PARENTS & my FAMILY** for not only giving me life but giving your entire life to me. I am indebted to both of you a lot, indeed more than my life & to my lovely WIFE to bear with me in all the time I spend on making notes. And last to all my **CRITICS** because your criticism continuously keep me grounded and give me power to do even better. Every care has been taken to make the presentation is this book from blemish. Nevertheless, it is conceded that no one is infallible, unintended error or omission may have crept in. The user of this book are requested to bring these to the notice of the author & offer, without Inhibition, their suggestion for further improvement.

Let us remind you two important things

1. This book is not a substitute for study material issued by ICAI, it's only an aid.
2. There is no short cut to success, it is resolute hard work that pays.

“Quality is what I serve, & my Passion drives it”



CA. CS. Vijay Sarda

Ekatvam Academy, Pune.





CA VIJAY SARDA or Ekatvam  
Academy [Learn Virtually]



@Ca\_vijay\_sarda  
[ Lets Share some Snaps]



CA Vijay Sarda III  
[Be Friends for Life]



Ca vijay sarda  
[ sharing & caring]

All rights reserved. No part of this book should be copied, reproduced, stored in retrieval system, or transmitted, in any form, or by any means, electronic, mechanical, photocopying, recording, or otherwise, without obtaining prior permission in writing from the Author.  
©Author

Color Code used in the book :



General Concept



Important



Amendments



Headings

Chap	Chapter Name	Page No
1.	Basics of Income Tax Calculation	1.1 - 1.14
2.	Residential Status	2.1 - 2.9
3.	Agriculture Income	3.1 - 3.2
4.	House Property	4.1 - 4.7
5.	Income From Salary	5.1 - 5.14
6.	Income from other sources	6.1 - 6.9
7.	Capital Gains	7.1 - 7.16
8.	Profits & Gains from Business/ Profession	8.1 - 8.21
9.	Clubbing of Income	9.1 - 9.5
10.	Set off & Carry forward	10.1 - 10.6
11.	Deductions	11.1 - 11.11
12.	Exemptions	12.1 - 12.4
13.	Tax Deducted at Source & Tax Collected at Source	13.1 - 13.19
14.	Advance Tax	14.1 - 14.4
15.	Return of Income	15.1 - 15.10
16.	Alternate Minimum Tax	16.1 - 16.2
17.	Computation of Total Income	17.1 - 17.3

# Chapter 1

## BASICS OF INCOME TAX & TAX CALCULATION

### IMPORTANT AMENDMENTS/ NOTIFICATIONS/CIRCULARS

Sr No.	Particulars	Pg No
1	Constitutional validity of Income Tax	1.2
2	Basics of Income Tax	1.2
3	Notifications, Circulars & Judicial Updates	1.2
4	Annual Amendments	1.2
5	Important Definitions	1.2
6	Tax rates for I/HUF/AOP/BOI/AJP	1.3
7	Tax rates for Firm/Companies/Co-Operative Society	1.5
8	For Other Assessee or Persons - Surcharge	1.5
9	Marginal relief	1.5
10	Alternative Tax Scheme - Default Scheme [FA 2023]	1.6
11	Sec 115BAC Tax Incentive for Individual & HUF	1.6
12	Slab Rates	1.7
13	Sec 115BAD Tax Incentive for Resident Co-operative Society	1.8
14	Sec 115BAE Tax on income of certain new manufacturing co-op societies	1.9
15	Sec 115BAB & 115BAA Optional tax rate For Companies	1.10
16	Undisclosed Sources of Income	1.11
17	Sec 115BBE Unexplained money, investments etc. to attract tax @60%	1.12
18	Unsolved Questions	1.13

Sr No.	Particulars	Pg No
1	Surcharge rates	1.5
2	Alternate Tax Scheme [FA2023]	1.6
3	Rebate in 115BAC	1.7
4	Marginal relief in rebate u/s 115BAC	1.7
5	Sec 115BAE for Co. operative society	1.9



“

**PADHO toh  
HADDH kardo**  
**Warna PROGRAM  
RADDH kardo**

Basics  
1.1

CA CS VIJAY SARDA  +91 8956651954

[www.ekatvamacademy.com/www.vlearnclasses.com](http://www.ekatvamacademy.com/www.vlearnclasses.com)



## Constitutional Validity

<b>Article 265</b>	No Tax can be levied or collected except by authority of Law
<b>Article 270</b>	All the taxes & duties except specified shall be levied by CG & distributed between Union & state Government in the manner specified by President or through recommendation of finance commission
<b>Article 245</b>	Parliament may make law for the whole or part of the territory
<b>Article 123</b>	President may Promulgate Ordinances during recess of Parliament
<b>Article 271</b>	Parliament may at any time increase any duties & taxes as referred in article 270, by surcharge for purpose of Union & whole proceeds of any such surcharge shall form part of CFI

## Basics of Income Tax

- > Income tax is covered under entry no 82 of the union list.
- > Agriculture Income is covered under Entry no 46 to State List
- > It is applicable to whole of India (Sec 1)
- > **PY shall be 23-24 and AY shall be 24-25**

## Notifications Circulars Judicial Updates

> Notification is communication of any change in Act/Rules	> Issued by CBDT u/s 119	> Notification over-rides Act	> All Notification 6M before exam are applicable
> Clarification issued by Dept	> Issued by CBDT u/s 119	> All Circulars 6M before exam are applicable	> These are binding on dept not on Assessee
> <b>Supreme Court</b> : Approached when :	a) HC frames a question of law;	b) A SLP is filed; Judgments of SC become law of land	> <b>High Court</b> : Only handles question of law. File Writ petition
			> <b>ITAT</b> : Last authority for question of fact

## Annual Amendments

Every year along with Budget a Financial Bill is presented. The provisions of such Finance Act are thereafter incorporated in the Income-tax Act

<b>Direct Tax Amendments</b>	Effective from 1st day of Next Year, Unless Specified Otherwise
<b>Indirect Tax Amendments</b>	Effective from Midnight, Unless Specified Otherwise [Now after GST, amendment are expected after every GST Council Meet

## Important Definitions

<b>Sec 2(9)</b>	<b>Assessment Year</b>	Means period of 12 M commencing on 1st day of April every year. (AY = FY in which tax is paid)
<b>Sec 3</b>	<b>Previous Year</b>	Means FY immediately preceding AY. (PY = FY in which income is earned). In case of Business commencement PY, starts from Date of commencement"
	<b>Exceptions to PY</b>	<b>Sec 172</b> Income of NR shipping companies
	<b>Income of PY taxable in PY itself instead of AY</b>	<b>Sec 174</b> Income of persons leaving India with no intention of returning to India <b>Sec 174A</b> Assessment of AOP/BOI/AJP formed for a particular purpose likely to be dissolved in same year of formation <b>Sec 175</b> Assessee likely to transfer his assets with view to avoid payment of tax
	<b>Sec 176</b>	Income of a discontinued business or profession
<b>Sec 2(31)</b>	<b>Person</b>	Includes Individual; HUF; Company; Firm (Include LLP except for Sec 44AD/44ADA); AOP; Local Authority; AJP
<b>Sec 2(7)</b>	<b>Assessee</b>	Person liable to pay tax, a deemed assessee; a person who is in default



## Tax Rates

**Normal Rates :** Specified by relevant Finance Act

**Special Rates :** Specified by Income Tax Act

### I/HUF/AOP/BOI/AJP (OLD SCHEME)

**Individual:** In case of every Individual viz Male, female, & below the age of 60 years on the last day of PY, any AOP, BOI, HUF, AJP, Non Resident (Irrespective of Age).

Total Income	Amount of tax
Upto ₹2,50,000	Nil
Exceeding ₹2,50,000 but upto ₹5,00,000	5% of (total income less ₹2,50,000)
Exceeding ₹5,00,000 but upto ₹10,00,000	₹12500 + 20% of (TI less ₹5,00,000)
In excess of ₹10,00,000	₹112500 + 30% of TI

**Senior citizens:** Individual [Resident] 60 years or more but not more than 80 years

Total Income	Amount of tax
Upto ₹3,00,000	Nil
Exceeding ₹3,00,000 but upto ₹5,00,000	5% of (total income less ₹3,00,000)
Exceeding ₹5,00,000 but upto ₹10,00,000	₹10,000 + 20% of (TI less ₹5,00,000)
In excess of ₹10,00,000	₹1,10,000 + 30% of TI

**Super Senior citizens:** Individual [R] who is of age of 80 years or more

Total Income	Amount of tax
Upto ₹ 5,00,000	Nil
Exceeding ₹5,00,000 but upto ₹10,00,000	20% of (TI less ₹5,00,000)
In excess of ₹10,00,000	₹1,00,000 + 30% of TI

**Notes :**

1) HEC is applicable @ 4%. [after surcharge or Rebate]

2) Rebate u/s 87A :-

- Assessee is Individual
- He is Resident in India
- Whose TI (From All Heads after Deduction) does not exceed ₹5 lakh  
 Rebate = ₹12500 or 100% of tax payable, whichever is lower  
 > Rebate not available for tax computed u/s 112A

d) Rounding Off :

Sec 288A	Round off of Total Income	R/o to nearest multiple of ₹10
Sec 288B	Round off of Total Tax	R/o to nearest multiple of ₹10

Rule of 5 is applicable

Eg:- If tax calculated is 81,501 then tax be rounded off to 81,500.

**Circular 28/2016 -**

Any resident Individual whose 60th/80th birthday falls on 1st April 2024 shall be treated as having completed the age of 60/80 years on 31st March 2024 i.e PY 2023-24 (AY 2024-25) and hence would be eligible for the higher basic exemption limit of ₹ 3,00,000 & 5,00,000.

[Case: Prabhu Dayal Sesma vs. State of Rajasthan]

e) **Special Adjustment** - If Assessee (Resident) has special Income i.e. LTCG (112/112A)/STCG (111/111A) (Not casual Income) & BEL is not exhausted then such special income shall be first used to cover up BEL & balance, if any shall be chargeable to special rate of Tax.

f) **Surcharge** : Applicable to Individual, HUF, AOP, BOI, AJP - As per Taxation law amendment ordinance 2019 & FA'22

No	Income	Surcharge on Income	
		111A, 112, 112A & dividend	Other
1)	TI [Including Income u/s 111A, 112, 112A & div. does not exceed 50L	Nil	Nil
2)	TI [Incl Income u/s 111A, 112, 112A & dividend exceed 50L but not 1cr]	10%	10%
3)	TI [Incl Income u/s 111A, 112, 112A & dividend exceed 1cr but not 2cr]	15%	15%
4)	TI [Excl. Income u/s 111A, 112, 112A & dividend exceed 2cr but not 5cr.]	15%	25%
5)	TI [Excluding Income u/s 111A, 112, 112A & dividend exceed 5cr]	15%	37%
6)	TI [Incl Income u/s 111A, 112, 112A & dividend exceed 2cr but not covered by situation 4 & 5]	15%	15%



Particulars	Rate	Example	
		Components of total income	Applicable rate of surcharge
Where the total income (including dividend and capital gains chargeable to tax u/s 111A, 112 and 112A) > ₹50 lakhs but ≤ ₹1 crore	10%	<ul style="list-style-type: none"> <li>Dividend ₹10 lakhs;</li> <li>STCG u/s 111A ₹20 lakhs;</li> <li>LTCG u/s 112 ₹15 lakhs;</li> <li>LTCG u/s 112A ₹20 lakhs; and</li> <li>Other income ₹25 lakhs</li> </ul>	Surcharge would be levied @10% on income-tax computed on total income of ₹90 lakhs.
Where total income (including dividend income and capital gains chargeable to tax u/s 111A, 112 and 112A) > ₹1 cr but ≤ ₹2 crore	15%	<ul style="list-style-type: none"> <li>Dividend income ₹10 lakhs;</li> <li>STCG u/s 111A ₹40 lakhs;</li> <li>LTCG u/s 112 ₹55 lakhs;</li> <li>LTCG u/s 112A ₹35 lakhs; and</li> <li>Other income ₹50 lakhs</li> </ul>	Surcharge would be levied @15% on income-tax computed on total income of ₹1.90 crores.
Where total income (excluding dividend income and capital gains chargeable to tax u/s 111A, 112 and 112A) > ₹2 crore but ≤ ₹5 crore	25%	<ul style="list-style-type: none"> <li>Dividend income ₹51 lakhs;</li> <li>STCG u/s 111A ₹44 lakhs;</li> <li>LTCG u/s ₹42 lakhs;</li> <li>LTCG u/s 112A ₹55 lakh; and</li> <li>Other income ₹3 crores</li> </ul>	Surcharge@15% would be levied on income-tax on: <ul style="list-style-type: none"> <li>Dividend income ₹51 lakhs;</li> <li>STCG of ₹44 lakhs chargeable to tax u/s 111A;</li> <li>LTCG of ₹42 lakhs chargeable to tax u/s 112; and</li> <li>LTCG of ₹55 lakhs chargeable to tax u/s 112A. Surcharge @25% would be leviable on income-tax computed on other income of ₹3 crores included in total income</li> </ul>
The rate of surcharge on the income-tax payable on the portion of dividend income and CG chargeable to tax u/s 111A, 112 and 112A	Not exceeding 15%		

Particulars	Rate	Example	
		Components of total income	Applicable rate of surcharge
Where total income (excluding dividend income and Capital Gain chargeable to tax u/s 111A, 112 and 112A) > ₹5 crore	37%	<ul style="list-style-type: none"> <li>Dividend income ₹60 lakhs;</li> <li>STCG u/s 111A ₹50 lakhs;</li> <li>LTCG u/s 112 ₹42 lakhs;</li> <li>LTCG u/s 112A ₹65 lakhs; and</li> <li>Other income ₹6 crore</li> </ul>	Surcharge@15% would be levied on income-tax on: <ul style="list-style-type: none"> <li>Dividend income of ₹60 lakhs;</li> <li>STCG of ₹50 lakhs chargeable to tax u/s 111A;</li> <li>LTCG of ₹42 lakhs chargeable to tax u/s 112; and</li> <li>LTCG of ₹65 lakhs chargeable to tax u/s 112A</li> </ul>
Rate of surcharge on the income-tax payable on the portion of dividend income and capital gains chargeable to tax u/s 111A, 112 and 112A	Not exceeding 15%		
Where total income (including dividend income and capital gains chargeable to tax u/s 111A, 112 and 112A) > ₹2 crore in cases not covered under (iii) and (iv) above	15%	<ul style="list-style-type: none"> <li>Dividend income ₹55 lakhs;</li> <li>STCG u/s 111A ₹60 lakhs;</li> <li>LTCG u/s 112 ₹42 lakhs;</li> <li>LTCG u/s 112A ₹55 lakhs; and</li> <li>Other income ₹1.10 crore</li> </ul>	Surcharge would be levied @15% on income-tax computed on total income of ₹3.22 crore.

# Tax rate for Companies

## General Rates for Companies

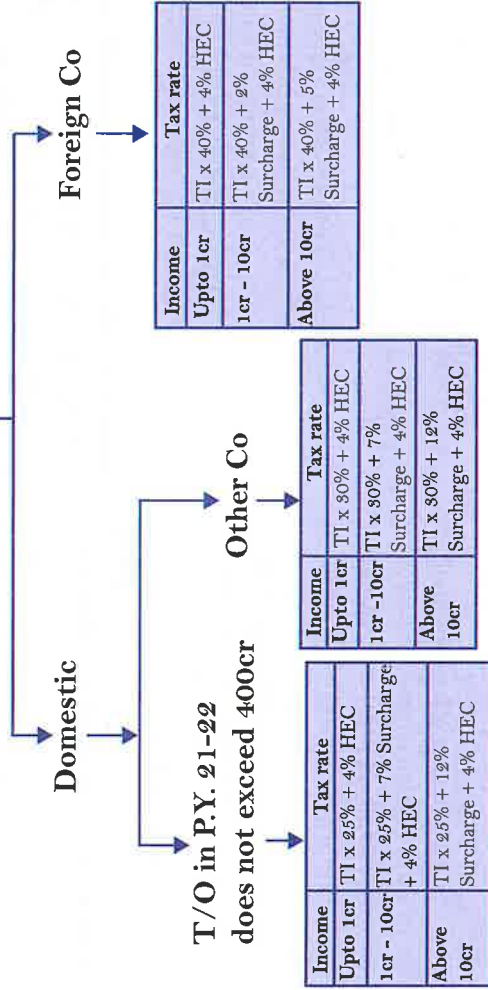

## For Other Assessee or Persons - Surcharge

Assessee	Rate of Tax	Applicable Surcharge		Rate of HEC
		TI < 1 Cr	1 Cr < TI < 10 Cr	
Domestic Co turnover not exceed not exceed 400 crore in PY 21-22	25%	-	7%	4%
Other Companies	30%	-	7%	4%
Foreign Company	40%	-	2%	4%
Firm & LLP	30%	-	12%	4%
Local Authority	30%	-	12%	4%
Co Operative Society	10%	-	-	4%
For 1st ₹10,000	20%	-	-	4%
For next ₹10,000	30%	-	7%	4%
For the balance	30%	-	12%	4%

## An AOP consisting of only companies as members :

- (a) In case of an AOP consisting of only companies as members, whose total income > ₹ 50 lakhs but is ≤ ₹ 1 crore Where the total income exceeds ₹ 50 lakhs but does not exceed ₹ 1 crore, surcharge is payable at the rate of 10%
  - (b) In case of an AOP consisting of only companies as members, whose total income > ₹ 1 crore Where the total income exceeds ₹ 1 crore, surcharge is payable at the rate of 15%
- # In case of AOP (consisting of only companies as its member), the maximum of rate of surcharge is 15% for AY 2023 & 24

## Marginal Relief

- A) In case of an Local Authority & Firm, where TI < ₹ 1cr, aggregate of income tax & surcharge shall be restricted to:  
(Tax on ₹1cr) + (Total Income - ₹1cr)

## B) In case of an Individual & HUF :

Total Income	Income tax & Surcharge restricted to
₹ 50L < / = ₹ 1cr	(Tax on ₹50 lakhs) + (Total Income - ₹50 lakhs)
₹ 1cr < / = ₹ 2cr	(Tax on ₹1 crore with surch @ 10%) + (Total Income - ₹1 crore)
₹ 2cr < / = ₹ 5cr	(Tax on ₹2 crore with surch @ 15%) + (Total Income - ₹2 crore)
Exceeds ₹5cr	(Tax on ₹5 crore with surch @ 25%) + (Total Income - ₹5 crore)

- C) In case of a Domestic / Foreign Company, where TI ₹ 1cr < / = ₹ 10cr, aggregate of income tax & surcharge shall be restricted to:  
(Tax on ₹1cr) + (Total Income - ₹1cr)

- D) In case of a Domestic Company, where TI > ₹ 10cr, aggregate of income tax & surcharge shall be restricted to:  
(Tax on ₹10cr with surch of 7%) + (Total Income - ₹10cr)

- E) In case of a Foreign Company, where TI > ₹ 10cr, aggregate of income tax & surcharge shall be restricted to:  
(Tax on ₹10cr with surch of 2%) + (Total Income - ₹10cr)



## f) SPECIAL RATES :

Income	Rates
STCG referred to in sec 111A (Securities)	15%
LTCCG referred to in sec 112	20%
LTCCG u/s 112A Beyond ₹ 1Lakh	10%
Casual incomes (e.g. Lottery, horse winnings, etc.) (Sec 115BB)	30%
Sec 115 BBJ Net winnings from online games [FA 2023]	30%
Sec 115BBG Income from transfer of carbon credit	10%
Unexplained Cash/Expenses/Investment-115BBE	60%
Maximum Marginal rate	42.744% [30% + 37% + 4%]

## Alternative Tax Scheme - Default Scheme (w.e.f A.Y. 2024-25) [FA 2023] New Scheme

Unless otherwise Specified w.e.f A.Y. 2024-25 tax shall be calculated as per below sections unless it is specifically mentioned that calculate as per old scheme

### New Scheme :-

Sec 115 BAC	I/HUF AOP/BOI/AJP (Other than Co.op) - R/NR
Sec 115 BAA	Any Domestic Company
Sec 115 BAB	Any Domestic Manufacturing Company
Sec 115 BAD	Any Co.op Society - R
Sec 115 BAE	A.Y. 24-25 Co.op Society engaged in MNF.

# Firm/LLP / Local Authority / Foreign Co - No Alternative Tax Scheme available as of now

## Sec 115BAC Tax Incentive for Individual & HUF

For Individual /HUF / AOP/ BOI/ AJP have an option to opt for taxation in sec 115BAC of the Act.

**Condition :** 1 Restriction on claiming deduction or exemption

**Following Deduction can't be Taken Without exemption/ deduction under the foll provisions:**

### Salary:

1. Leave travel concession sec10(5)
2. House rent allowance sec10(13A)
3. Entertainment allowance & employment/professional tax u/s 16;
4. Free food & beverage through vouchers provided to EE
5. Some of the allowance mentioned in sec10(14)

### HP:

1. Interest u/s 24 in respect of self-occupied or vacant property referred to in Sec 23(2). (Loss from house property for rented house not be allowed to be set off under any other head & would be allowed to be c/f as per extant law)

### PGBP:

1. Additional deprecation u/s 32(1)(ia);
2. Deductions u/s 32AD, 33AB, 33ABA
3. Various deduction for donation for or expenditure on scientific research contained

- in sub-clause (ii) / (ia) / (iii) of sub-sec (1) / sub-sec (2AA) of sec 35;
4. Deduction u/s 35AD or sec 35CCC;

### IFOS:

1. Deduction from family pension u/s 57(ia);

### Deduction:

1. Any deduction under chapter VIA

### Exemptions:

1. Allowances to MPs/MLAs sec 10(17)
2. Allowance for income of minor sec10(32)
3. Exemption for SEZ unit contained in section 10AA

**Following Deduction can be Taken**

### Salary:

1. Transport Allowance granted to a divyang employee
2. Conveyance Allowance
3. Any Allowance granted to meet the cost of travel on tour or on transfer
4. Daily Allowance to meet ordinary daily charges incurred by an employee on absence from his normal place of duty
5. Standard deduction u/s 16(ia)

### Deduction:

1. Deductions Sec 80CCD (employer contribution on account of employee in notified pension scheme) & Sec 80JJAA (new employment), 80CCH (CG contribution towards Agnipath scheme)

### PGBP:

1. Depreciation is allowed.



**Condition 2:** Without Set off of any loss c/f or depreciation from an earlier AY, if the same is attributable to any of the deductions referred in point A. Also, without setting off any loss under the head House Property with any other head of income. Both the losses mentioned cannot be c/f

**Condition 3 Exercise the option:**

- 1. I/ HUF/ AOP/ BOI/ AJP has no Business Income:** Along with the return of income be furnished u/s 139(1);
- 2. Has Business Income :** On or before the due date specified u/s 139(1) for furnishing ROI & such option once exercised shall apply to subsequent AYs
  - > The Option can be withdrawn only once where it was exercised by the Assessee having business income for a PY other than the year in which it exercised & thereafter, the Assessee shall never be eligible to exercise the option under this section, except where such individual or HUF ceases to have any business income.

## Slab Rates

**Old (A.Y. 23-24)**  
Sec 115 BAC(1)

Total Income	Rate (%)
Upto ₹ 2,50,000	Nil
₹ 2.5L to 5L	5%
₹ 5L to 7.5L	10%
₹ 7.5L to 10L	15%
₹ 10L to 12.5L	20%
₹ 12.5L to 15L	25%
Above ₹ 15L	30%

**New(Default)**  
Sec 115BAC (1A) [FA 2023]

Total Income	Rate (%)	Shortcut
Upto ₹ 3,00,000	Nil	-
₹ 3L to 6L	5%	15000
₹ 6L to 9L	10%	30000
₹ 9L to 12L	15%	45000
₹ 12L to 15L	20%	60000
Above ₹ 15L	30%	-

**Rebate u/s 87A :**

- 1) Assessee is Individual
  - 2) He is Resident in India
  - 3) Whose total income (From All Heads after Deduction) (Normal + Special excluding Agriculture Income and Exempt Income) does not exceed ₹7 lakh
- Rebate= ₹25000 or 100% of tax payable, whichever is lower**  
Rebate not available for tax computed u/s 112A [FA'23]

### # Marginal relief incase of income slightly exceed 7L:

Rebate u/s 87A is subject to marginal relief from A.Y. 24-25, if net income exceed 7 Lakh but does not exceed 7,27,770 income tax on such income cannot exceed the amount by which net income exceed 7 lakh

Eg 1 : Total Income 6,92,000

Solution : Upto First 3,00,000 - NIL  
 Next 3,00,000 - 5% - 15,000  
 92000 - 10% - 9,200  
 Total tax 24,200  
 (-) Rebate u/s 87A (24,200)  
 Tax NIL

Eg 2 : Total Income 7,20,000 with marginal relief

Solution : Upto First 3,00,000 - NIL  
 Next 300000 - 5% - 15,000  
 1,20,000 - 10% - 12,000  
 Total tax 27,000

Marginal Relief

= (Tax on 7 lakh ) + (TI - 7 lakh)  
 = Nil + 20000  
 = 20,000 (+ HEC @4%)  
 = 20,800

i.e Tax cannot exceed 20,800

Eg 3 : Total Income 7,25,000 with marginal relief

Solution : Upto First 3,00,000 - NIL  
 Next 300000 - 5% - 15000  
 1,25,000 - 10% - 12500  
 Total tax 27500

Marginal Relief

= (Tax on 7 lakh ) + (TI - 7 lakh)  
 = Nil + 25000  
 = 25000 (+ HEC @4%)  
 = 26000

i.e Tax cannot exceed 26000



## # Further Points

### 1. Income Chargeable at Special rate

Income	Rates
STCG referred to in Sec 111A (Securities)	15%
LTCG referred to in Sec 112	20%
LTCG u/s 112 A Beyond ₹1 Lakh	10%
Casual income (e.g. Lottery, Horse winnings, etc.) (Sec 115 BB) [FA 23]	30%
Online Winning 115BBJ [FA 2023]	30%
Income from transfer of carbon credit Sec 115G [FA 2023]	10%

### 2. Surcharge : I / HUF / AOP / BOI / AJP as:

Sr	Income	u/s 111A, 112 112A, Dividend Income	Other
1)	TI [including Income u/s 111A, 112, 112A & dividend income does not Exceed 50L.]	Nil	Nil
2)	TI [including Income u/s 111A, 112, 112A & dividend income exceed 50L but does not exceed 1cr.]	10%	10%
3)	TI [including Income u/s 111A, 112, 112A & dividend income exceed 1cr but does not exceed 2cr.]	15%	15%
4)	TI [excluding Income u/s 111A, 112, 112A & dividend income exceed 2cr but does not exceed 5cr.]	15%	25%
5)	TI [excluding Income u/s 111A, 112, 112A & dividend income exceed 5cr.]	15%	25% [FA 23]
6)	TI [including Income u/s 111A, 112, 112A & dividend income exceed 2cr but not covered by situation 4 & 5]	15%	15%

**Note :** If surcharge is applicable on taxable Income of assessee as per specified limits, maximum surcharge applicable on Tax on Dividend Income is up to 15% of Tax Amount. (i.e. if your income is in slab limit of surcharge of 25%, tax on dividend income will be having capping on surcharge on tax @ 15% on tax amount proportionate to total tax with income.

## Sec 115BAD Tax Incentive for Resident Co-operative Society

The condition for concessional rate shall be that the total income of co-operative society is computed -

### A. Without claiming the following deductions :

- > Exemption for SEZ unit contained in section 10AA
- > Additional Depreciation u/s 32(1)(iia)
- > Deductions u/s 32AD, 33AB, 33ABA sub-clause (ii) or sub-clause (iia)/ sub-clause (iii) of sub-sec (1) or sub-sec (2AA) of sec 35/35AD/35CCC
- > Provisions under Chapter VI A except 80JJAA

B. Without Set off of any loss c/f or depreciation from an earlier AY, if the same is attributable to any of the deductions referred in point A. Also, the same cannot be carried forward.

### C. By claiming Depreciation u/s 32 except Additional depreciation :

- > The concessional rate shall not apply unless option is exercised by the co-operative society in the prescribed manner on or before the due date specified u/s 139(1) of the Act for furnishing the returns of income for any PY relevant to the A.Y. commencing on or after 1st April, 2021 and such option once exercised shall apply to subsequent AY.
- > Provisions of Sec 115JC, AMT, shall not apply to such Resident Co-operative Society. Similarly, provisions in Sec 115JD relating to carry forward and set off of AMT credit, if any, shall not apply.
- > Option once exercised cannot be withdrawn;
- > On fulfillment of above conditions, a co-operative society resident in India shall have the option to pay tax at 22% for AY 2021-22 onwards in respect of its total income so however that if it fails to satisfy conditions in any PY, the option shall become invalid and other provisions of the Act shall apply. The surcharge applicable to such co-op society shall be levied at 10% (Effective rate 25.168%)

## Sec 115BAE Tax on income of certain new manufacturing co-op societies

1. **Assessee** - Engaged in Manufacturing, Co.op Society in India (Resident)
2. **Following are not considered as manufacturing**
  - (i) Development of computer software in any form or in any media;
  - (ii) Mining;
  - (iii) Conversion of marble blocks or similar items into slabs;
  - (iv) Bottling of gas into cylinder;
  - (v) Printing of books or production of cinematography film; or
  - (vi) Any other business as may be notified by the Central Government in this behalf;

### 3. Tax Rates :

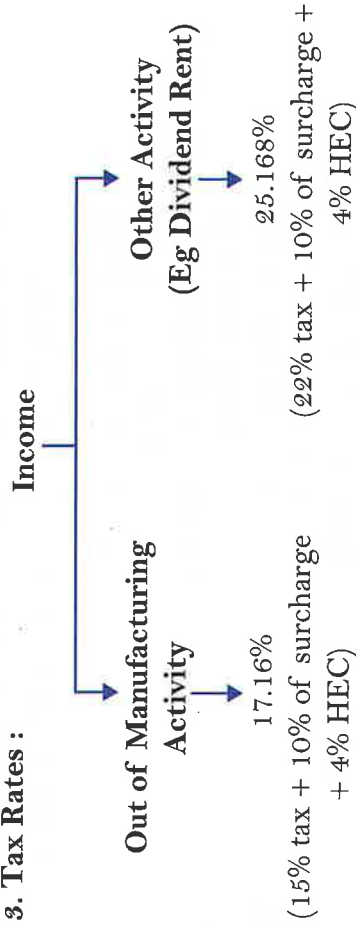

4. Option once taken cannot be withdrawn
5. Deduction u/s 115BAD cannot be taken
6. This option needs to be taken before filing ITR for A.Y. 24-25
7. If losses and unabsorbed depreciation arise because of above deduction it cannot be taken.

### 8. Additional conditions -

- a. It must be registered on or after 1/4/2023 and should commence manufacturing or production of an article or thing on or before 31.3.2024
- b. It should not be formed by splitting up or the reconstruction of a business already in existence (except in case of a company, business of which is formed as a result of the re-establishment, reconstruction or revival by the person of the business of any undertaking referred to in sec 33B in the circumstances and within the period specified therein)
- c. It does not use any machinery or plant previously used for any purpose
  - i) Any P&M which was used outside India & is imported into India from any country outside India;
  - ii) No deduction on account of depreciation is allowed in Income-tax Act, 1961 in India earlier
  - iii) Value of Second hand P&M does not exceed 20% of the total value of P&M.
- d. It should not be engaged in any business other than the business of manufacture or production of any article or thing and research in relation to, or distribution of, such article or thing manufactured or produced by it.
- e. When AO comes across a transaction between Assessee and other persons where Profit Generated to another persons generate more than ordinary profit then AO can club the additional income and such income shall be taxed @30%



## Sec 115BAB & 115BAA Optional tax rate For Companies

Particulars	Section 115BAB	Section 115BAA
1. Applicability	Domestic manufacturing company	Any domestic company
2. Rate of tax	15%	22%
3. Rate of surcharge	10%	10%
4. Effective rate (including surcharge & HEC)	17.16% [Tax@15% (+) Surcharge @10% (+) HEC@4%]	25.168% [Tax@22% (+) Surcharge @10% (+) HEC @4%]
5. Applicability of MAT	Not applicable	Not applicable
6. Manner of computation of tax liability		
Income on which concessional rate of tax is applicable	The rate of tax (i.e., 17.16%) is applicable in respect of income derived from or incidental to manufacturing or production of an article or thing.	The rate of tax (i.e., 25.168%) is notwithstanding anything contained in the Income-tax Act, 1961, but subject to the provisions of Chapter XII, other than sec 115BA and 115BAB.
Rate of tax on Special Income [for example, LTCG chargeable to tax u/s 112 and 112A, STCG chargeable to tax u/s 111A]	Special Income is Taxable at Special rate + 10% Surcharge + 4% HEC	Special Income is Taxable at Special rate + 10% Surcharge + 4% HEC

Rate of tax on other income [HP/IFOS]	The applicable tax rate is 25.168% (i.e., tax @22%, plus surcharge @10% plus HEC @4%)	The applicable tax rate is 25.168% (i.e., tax @22% plus surcharge @10% plus HEC@4%).
AO club income because of close connection	The rate of 34.32% (i.e., Tax @30% + surcharge @10% + HEC@4%) would be applicable in specified circumstance	-
7. Other Points	<p>a. It must be registered on or after 1/4/2019 and should commence manufacturing or production of an article or thing on or before <b>31.3.2024</b></p> <p>b. It should not be formed by splitting up or the reconstruction of a business already in existence (except in case of a company, business of which is formed as a result of the re-establishment, reconstruction or revival by the person of the business of any undertaking referred to in sec 33B in the circumstances and within the period specified therein)</p> <p>c. It does not use any machinery or plant previously used for any purpose</p> <p>i) Any P&amp;M which was used outside India &amp; is imported into India from any country outside India;</p>	<p>a. If losses and unabsorbed depreciation arise because of above deduction it cannot be taken.</p> <p>b. Option once taken cannot be withdrawn</p>

- ii) No deduction on account of depreciation is allowed in Income-tax Act, 1961 in India earlier
- iii) Value of Second hand P&M does not exceed 20% of the total value of P&M.
- d. It does not use any building previously used as a hotel or a convention centre
- e. If losses and unabsorbed depreciation arise because of above deduction it cannot be taken
- f. Option once taken cannot be withdrawn
- g. **Business of manufacture or production of any article or thing does not include business of -**
  - i) Development of computer software in any form or in any media
  - ii) Mining
  - iii) Conversion of marble blocks or similar items into slabs
  - iv) Bottling of gas into cylinder
  - v) Printing of books or production of Cinematography films
  - vi) Any other business as may be notified by the Central Govt. in this behalf.

8. **Following deductions not allowed**
- a. PGBP
    - i) Additional dep u/s 32(1)
    - ii) Scientific research u/s 35
    - iii) Specified business u/s 35AD
    - iv) Agriculture extension project u/s 35CCC
    - v) Skill development project u/s 35CCD
    - vi) Deduction u/s 32AD, 33AB, 33ABA
  - b. Exemptions u/s 10AA
  - c. Deduction - All deductions except u/s 80JAA, 80LA, 80M

## Undisclosed Sources of Income

**Sec 68: Cash Credits :** Where any sum is found credited in the books of an assessee maintained for any previous year and the assessee offers no explanation about the nature and source or the explanation offered is not satisfactory in the opinion of the AO, the sum so credited may be charged as income of the assessee of that previous year.

**Unexplained loan or borrowing :** Where the sum so credited consists of loan or borrowing or any such amount, by whatever name called, any explanation offered by the assessee in whose books such sum is credited shall not be deemed to be satisfactory, unless -

- The person in whose name such credit is recorded in the books of such assessee also offers an explanation about the nature and source of such sum so credited; and
- Such explanation in the opinion of the Assessing Officer has been found to be satisfactory.

**Unexplained Share Capital/ Premium :** Any explanation offered by a closely held company in respect of any sum credited as share application money, share capital, share premium or any such amount, by whatever name called, in the accounts of such company shall be deemed to be not satisfactory, unless



- The person, being a resident, in whose name such credit is recorded in the books of such company also explains about the nature and the source of such sum so credited and
- Such explanation in opinion of AO has been found to be satisfactory.

### **Non-applicability to Venture Capital Fund or Venture Capital Company**

These additional conditions would not apply if the person, in whose name the sum is recorded, is a Venture Capital Fund or Venture Capital Company registered with SEBI

**Sec 69 Unexplained Investments :** Where in the FY immediately preceding the AY, the assessee has made investments which are not recorded in the books of account and the assessee offers no explanation about the nature and the source of investments or the explanation offered is not satisfactory in the opinion of the AO, the value of the investments are taxed as deemed income of the assessee of such FY.

**Sec 69A Unexplained money etc :** Where in any FY the assessee is found to be the owner of any money, bullion, jewellery or other valuable article and the same is not recorded in the books of account and the assessee offers no explanation about the nature and source of acquisition of such money, bullion etc. or the explanation offered is not satisfactory in the opinion of the AO, the money and the value of bullion etc. may be deemed to be the income of the assessee for such FY.

**Sec 69B Amount of investments etc., not fully disclosed in the books of account :** Where in any FY the assessee has made investments or is found to be the owner of any bullion, jewellery or other valuable article and the AO finds that the amount spent on making such investments or in acquiring such articles exceeds the amount recorded in the books of account maintained by the assessee and he offers no explanation for the difference or the explanation offered is unsatisfactory in the opinion of the AO, such excess may be deemed to be the income of the assessee for such financial year.

**Sec 69C Unexplained expenditure :** Where in any FY an assessee has incurred any expenditure and he offers no explanation about the source of such expenditure or the explanation is unsatisfactory in the opinion of the AO, AO can treat such unexplained expenditure as the income of the assessee for such FY. Such unexplained expenditure which is deemed to be the income of the assessee shall not be allowed as deduction under any head of income

**Sec 69D Amount borrowed or repaid on hundi :** Where any amount is borrowed on a hundi or any amount due thereon is repaid other than through an account-payee cheque drawn on a bank, the amount so borrowed or repaid shall be deemed to be the income of the person borrowing or repaying for the FY in which the amount was borrowed or repaid, as the case may be. However, where any amount borrowed on a hundi has been deemed to be the income of any person, he will not be again liable to be assessed in respect of such amount on repayment of such amount. The amount repaid shall include interest paid on the amount borrowed.

## **Sec 115BBE Unexplained money, investments etc. to attract tax @60%**

(i) In order to control laundering of unaccounted money by availing the benefit of basic exemption limit, the unexplained money, investment, expenditure, etc. deemed as income u/s 68 or section 69 or section 69A or section 69B or section 69C or section 69D would be taxed at the rate of 60% plus surcharge @25% of tax. Thus, the effective rate of tax (including surcharge@25% of tax and cess@4% of tax and surcharge) is 78%.

(ii) No basic exemption or allowance or expenditure shall be allowed to the assessee under any provision of the Income-tax Act, 1961 in computing such deemed income.

(iii) Further, no set off of any loss shall be allowable against income brought to tax u/s 68 or section 69 or section 69A or section 69B or section 69C or section 69D.

## Unsolved Questions

### P.1 Based on Marginal Relief

Compute the tax liability of Mr. Akash (aged 55 years), having total income of ₹ 1,01,00,000 for the AY 2024-25. Assume that his total income comprises of salary income, income from house property and interest from fixed deposit account.

### P.2 Based on Computation of marginal relief

Compute the tax liability of Mr. Deepak (aged 57 years), having total income of ₹2,02,00,000 for the AY 2024-25. Assume that his total income comprises of salary income, income from house property and interest from fixed deposit account. Also, assume that Mr. Deepak has not opted for the provisions of section 115BAC.

### P.3 Computation of tax liability

Find out the tax liability in the cases given below for the AY 2024-25 [these tax payers do not want to opt for the alternative tax regime u/s 115BAC] Assume that, applicable tax rate u/s 112 is 20 per cent

Different taxpayers ₹	Dividend ₹	Capital gain under section		Other Income ₹	Total ₹
		111A	112		
X (46 years) resident	-	6,00,000	3,00,000	7,00,000	59,00,000
					75,00,000

### P.4 Computation of tax liability

Find out the tax liability in the cases given below for the AY 2024-25 [these tax payers do not want to opt for the alternative tax regime u/s 115BAC] Assume that, applicable tax rate u/s 112 is 20 per cent

Different taxpayers ₹	Dividend ₹	Capital gain under section		Other Income ₹	Total ₹
		111A	112		
Z (24 years) resident	13,00,000	3,00,000	1,00,000	2,00,000	3,94,00,000
					3,53,00,000

### P.5 Computation of tax liability

Find out the tax liability in the cases given below for the AY 2024-25 [these tax payers do not want to opt for the alternative tax regime u/s 115BAC] Assume that, applicable tax rate u/s 112 is 20 per cent

Different taxpayers ₹	Dividend ₹	Capital gain under section		Other Income ₹	Total ₹
		111A	112		
A (52 years) resident	49,00,000	1,00,000	2,00,000	8,00,000	6,59,00,000
					15,11,00,000

### P.6 Computation of tax liability

Find out the tax liability in the cases given below for the AY 2024-25 [these tax payers do not want to opt for the alternative tax regime u/s 115BAC] Assume that, applicable tax rate u/s 112 is 20 per cent

Different taxpayers ₹	Dividend ₹	Capital gain under section		Other Income ₹	Total ₹
		111A	112		
B (41 years) resident	-	1,00,00,000	68,00,000	2,00,000	70,00,000
					2,40,00,000

### P.7 Based on Normal tax calculation with Rebate

Calculate the Tax Liability of Mr. Pranav age 43 years having the Following Income :

- Calculate the tax liability as per the Old regime
- Calculate the tax liability as per the New regime

Particulars	₹
Business Income	3,00,000
Dividend Income	1,50,000



### P. 8 Based on Special Income

Calculate Tax Liability of Ms. Vaishnavi age 52 years having Following Income

- Calculate the tax liability as per the Old regime
- Calculate the tax liability as per the New regime

Particulars	₹
Business Income	7,00,000
Other Sources	1,50,000
LTCG u/s 112	40,000
STCG u/s 111A	30,000

### P. 9 Based on Surcharge

Calculate Tax Liability of Mr. Stark age 55 years having Following Income

- Calculate the tax liability as per the Old regime
- Calculate the tax liability as per the New regime

Particulars	₹
Business Income	62,00,000
Other Sources	8,00,000
LTCG u/s 112	8,00,000
STCG u/s 111A	2,00,000

### P. 10 Based on Surcharge

Calculate Tax Liability of Mr. Rocket age 41 years having Following Income

- Calculate the tax liability as per the Old regime
- Calculate the tax liability as per the New regime

Particulars	₹
Business Income	2,70,00,000
LTCG u/s 112	51,00,000
STCG u/s 111A	48,00,000

# Chapter 2

## RESIDENTIAL STATUS

Sr. No	Particulars	Pg No
1	Basics of Residential Status	2.2
2	Residential Status of Individual	2.2
3	Residential Status For Other Assessee	2.2
4	Deemed Resident	2.2
5	Residential Status of HUF	2.3
6	Sec 6(3) Residential Status of Companies	2.4
7	Sec 5 Scope of Total Income & Tax Incidence	2.4
8	Deemed To Receive or Accrue	2.4
9	Sec 9(1) Income From Business Connection	2.5
10	Circular 13/2017	2.8
11	Unsolved Questions	2.8

### IMPORTANT AMENDMENTS/ NOTIFICATIONS/CIRCULARS

Sr No.	Particulars	Pg No
1	Residential Status of Individual	2.2



“

**BE  
TEACHABLE**

you are  
not always  
**RIGHT**

”

**RS  
2.1**

CA CS VIJAY SARDA  +91 8956651954

[www.ekatvamacademy.com/](http://www.ekatvamacademy.com/) [www.vlearnclasses.com](http://www.vlearnclasses.com)



## Basics of Residential Status

- Total Income of an Assessee cannot be computed unless we know residential status of the assessee during PY
- RS always determined for PY because we have to determine the total income of the PY only
- It is calculated for every year because it may change year to year
- A person can be resident of more than one country for any PY

## Residential Status of Individual

### Determining Residential Status of individual (Sec 6(1))

#### Other Assessee not covered in the 3 categories

They would be treated as Resident if satisfy any of following condition-

- If they stay in India for **182 days** or more in PY
- Stays in India for **60 days in PY AND 365 days in 4 continuous preceding PY**

#### For 3 category of cases

- Indian Citizen who leaves India in PY as a ship crew member of an Indian ship **or** for the purpose of employment outside India
  - They would be treated as Resident if they stay in India for **182 days** or more in PY
- Indian Citizen/Person of Indian Origin who being outside India comes on a visit to India in PY & total income (other than foreign income) is **15lakh or less**
  - They would be treated as Resident if they stay in India for **182 days** or more in PY
- Indian Citizen/Person of Indian Origin who being outside India comes on a visit to India in PY & total income (other than foreign income) is exceeding **15lakh**
  - They would be treated as Resident if satisfy any of following condition-
    - If they stay in India for **182 days** or more in PY **OR**
    - If the period of stay is **120 days** or more during the PY **AND 365 days** or more during the **4yrs** immediately preceding PY

IC / PIO having income exceeding 15L & liability to tax in another country

no Person treated as **RNOR** as per Sec 6(1A) & 6(6)

yes IRS depends upon period of stay in India when he visit India- Upto 120 days - **NR**  
 - Exceeding 120 days but less than 182 days & 365 days or more in 4 PPY - **RNOR** [6(1) & 6(6)]  
 - 182 days or more  
 - Sec 6(1) - **Resident**  
 - Sec 6(6) - **ROR or RNOR**

## Residential Status For Other Assessee

### Resident Sec 6[4]

If Control & Management Wholly or partly situated in India

### Non-Resident

If Control & Management Wholly Situated Outside India

## Deemed Resident

Notwithstanding anything contained in Sec 6(1), an individual, being citizen of India (not PIO), having total income, other than the income from foreign sources, exceeding 15,00,000 during the PY shall be deemed to be resident in India in that PY, if he is not liable to tax in any other country/territory by reason of his domicile/residence/any other criteria of similar nature As per Sec 6(6), If a person is deemed Resident as per Sec 6(1A) he shall deemed to be RNOR.

RS  
2.2

### # Person of Indian Origin:

A person is deemed to be of Indian origin if he, or either of his parents or any of his grandparents, was born in Undivided India. It may be noted that grandparents include both maternal and paternal grand parents.

### # Resident & Ordinarily Resident (ROR):

An individual may become a ROR in India if he satisfies both following conditions given u/s 6(6) besides satisfying any one of the above mentioned conditions:

- He is a resident in at least any 2 out of the 10 PYs immediately preceding the relevant PY, and
- He has been in India for 730 days or more during the 7 PYs immediately preceding the relevant PY.

### # Resident but Not Ordinarily Resident (RNOR):

An individual is RNOR in any PY if-

- He has been a NR in India in 9/10 PYs preceding that year, or
- He has during the 7 PYs preceding that year been in India for period of, or periods amounting in all to, 729 days or less
- A citizen of India, or a person of Indian origin, having total income, other than income from foreign sources, exceeding 15,00,000 during the PY, who has been in India for a period or periods amounting in all to 120 days or more but less than 182 days; or
- A citizen of India who is deemed to be resident in India - clause 6(1a)

### Rule 126 Computation of period of stay in India in certain cases -

An Individual, being a citizen of India and a member of the crew of a ship, the period of stay in India in respect of an eligible voyage shall not include the period beginning from the date of joining till the date of signing off as mentioned in the Continuous Discharge Certificate under the Merchant Shipping Act, 1958. "eligible voyage" shall mean a voyage undertaken by a ship engaged in the carriage of passengers or freight in international traffic where for the voyage having originated from any port in India, has as its destination any port outside India; & for the voyage having originated from any port outside India, has as its destination any port in India being citizen of India/ person of Indian origin within the meaning of expl. to sec 115C(e), who, being outside India, comes on visit to India in any PY.

## Residential Status of HUF

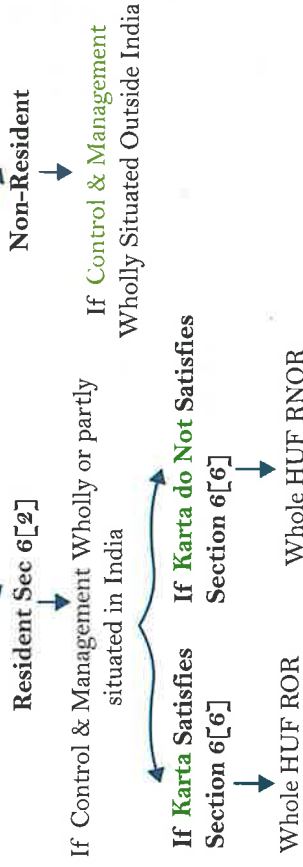

# Only Individual & HUF can be ROR/RNOR, other person can be Resident/NR



## Sec 6(3) Residential Status of Companies



**Explanation** - For the purposes of this clause "place of effective management" means a place where key management and commercial decisions that are necessary for the conduct of business of an entity as a whole are, in substance made.

**POEM :-** Place of Effective Management (Covered in Finals)

## Sec 5 Scope of Total Income & Tax Incidence

In order to understand relationship between residential status & Incidence it is necessary to understand meaning if Indian & Foreign income

### Indian Income:

1. Received In India
2. Deemed to be Received in India [Sec 7 & 8]
3. Accrued in India
4. Deemed to be accrued or arise in India [Sec 9]

### Foreign Income :

Income is not received or not deemed to be received in India. Income which does not accrue or arise in India.

### Remittance of Income:

**Approved mode** — Exempt in India  
**Unapproved Mode** — Taxable In India

**Past Foreign Untaxed Income brought to India:** Not taxable in India

## INCIDENCE OF TAX FOR INDIVIDUAL & HUF

Income	ROR	RNOR	NR
Indian	Taxable in India	Taxable in India	Taxable in India
Foreign	Taxable in India	Only two type of Foreign income is taxable in India. [Refer Notes]	Not Taxable in India

**Note :** Income from business/profession which is set up in India

## INCIDENCE OF TAX FOR OTHERS

Income	Resident	NR
Indian	Taxable in India	Taxable in India
Foreign	Taxable in India	Not Taxable in India

## Deemed To Receive or Accrue

### Deemed to be received in India [Sec.7]

- A) Contribution made by the employer to RPF beyond 12% of the salary [Upto 12% Exempt] (Refer Salary)
- B) Interest credited to Employee beyond 9.5% p.a. (Ref Salary)
- C) Transfer from URPF to RPF
- D) Contribution to pension fund u/s 80CCD (Refer Salary)

### Business Connection

1. Business Connection
2. Deemed Business Connection
3. Not a Business Connection

### Accrued In India [Sec.9]

- 1) Income out of Business Connection
- 2) Salary earned in India
- 3) Salary from government to an Indian citizen for services Rendered outside India
- 4) Dividend from Indian Co
- 5) Income from Interest payable by specified person
- 6) Income from Royalty
- 7) Income from Technical services
- 8) Income from Property/Assets situated In India
- 9) Income from transfer of Capital Assets situated In India
- 10) Gift(Money) by R to NR

## Sec 9(1) Income From Business Connection

The following incomes shall be deemed to accrue or arise in India :

**Sec 9(1)(i)** - All income accruing or arising, whether directly/indirectly, through or from any business connection in India, or through/from any property in India, or through or from any asset/source of income in India, or through the transfer of a capital asset situate in India.

### Explanation 1 - Not a business connection

For the purposes of this clause -

- 1) **In the case of a business other than the business having business connection in India on account of significant economic presence** of which all the operations are not carried out in India,
  - 2) In the case of NR, no income shall be deemed to accrue/arise in India to him through or from operations which are confined to the purchase of goods in India for the purpose of export;
  - 3) In the case of NR, being a person engaged in the business of running a news agency or of publishing newspapers, magazines or journals,
  - 4) In the case of NR, being—
    - a) An individual who is not a citizen of India ; or
    - b) A firm which does not have any partner who is a citizen of India/ who is resident in India ; or
    - c) A company which does not have any shareholder who is a citizen of India or who is resident in India, no income shall be deemed to accrue from operations which are confined to the shooting of any cinematography film in India;
  - 5) In the case of a foreign company engaged in the business of mining of diamonds, no income shall be deemed to accrue or arise in India to it through or from the activities which are confined to the display of uncut and unsorted diamond in any special zone notified by the CG in the Official Gazette in this behalf.

### Explanation 2 - Meaning of business connection

"Business connection" shall include any business activity carried out through a person who, acting on behalf of the NR -

- a) Has and habitually exercises in India, an authority to conclude contracts on behalf of the NR or habitually concludes
  - b) Has no such authority, but habitually maintains in India a stock of goods or merchandise from which he regularly delivers goods or merchandise on behalf of the non-resident; or
  - c) Habitually secures orders in India, mainly or wholly for the NR or for that non-resident and other non-residents controlling, controlled by, or subject to the same common control, as that non-resident.
- If a broker, general commission agent or any other agent having an independent status, then there is no Business connection.

### Explanation 2A Deemed Business Connection Significant Economic Presence - Significant economic presence of a NR in India shall constitute, It Means -

1. Transaction in respect of any goods, services or property carried out by NR with any person in India including provision of download of data or software in India, if the aggregate of payments arising from such transaction or transactions during the PY **exceeds Rs. 2 crore** or
2. Systematic and continuous soliciting of business activities/engaging in interaction with such number of users in India, **should exceed 3Lakh**

### **Transactions or activities shall constitute significant economic presence in India, whether or not—**

- (i) Agreement for such transactions/activities is entered in India; or
  - (ii) NR has a residence or place of business in India; or
  - (iii) NR renders services in India.
- Further only so much of income as is attributable to the transactions or activities carried out in India shall be deemed to accrue or arise in India



**Explanation 3A:** The income attributable to the operations carried out in India, as Shall include income from—

- a) Such advertisement which targets a customer who resides in India or a customer who accesses the advertisement through internet protocol address located in India;
- b) Sale of data collected from a person who resides in India or from a person who uses internet protocol address located in India; and sale of goods or services using data collected from a person who resides in India or from a person who uses internet protocol address located in India.

Provisions contained in this Explanation shall also apply to the income attributable to the transactions or activities referred to in Explanation 2A.

**Sec 9(1)(ii) - Salary Earned In India**

Income which falls under the head "Salaries", if it is earned in India.

**Explanation -** salary payable for the rest period or leave period which is preceded and succeeded by services rendered in India and forms part of the service contract of employment, shall be regarded as income earned in India;

**Sec 9(1)(iii) - Salary Earned Outside India**

Income chargeable under the head "Salaries" payable by the Government. However allowances or perquisite payable outside India would be exempt u/s 10(7)

**Sec 9(1)(iv) - Dividend From An Indian Company**

A dividend paid by an Indian company outside India;

**Sec 9(1)(v) - Interest payable to NR would be deemed to accrue in India if paid by**

- a) Government ; or
- b) Person who is resident,

**Exception:** where the interest is payable in respect of any debt incurred, or moneys borrowed and used, for the purposes of a business or profession carried on by him outside India or for the purposes of making or earning any income from any source outside India; or

- c) NR in respect of debt incurred or moneys borrowed and used, for the purposes of a business or profession carried on by such person in India

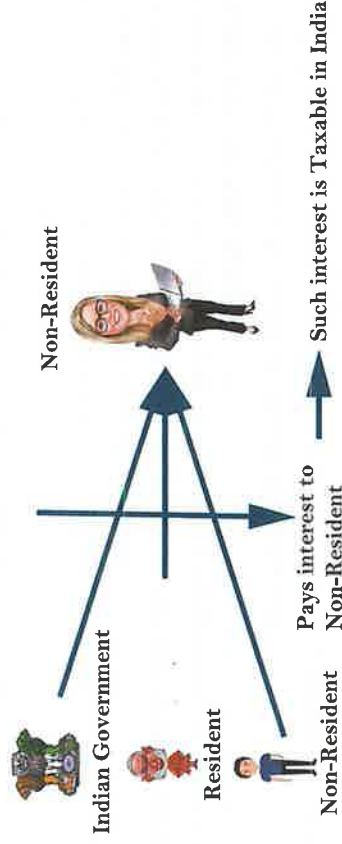

**Exception:** Interest on money borrowed by the NR for any purpose in India other than for Business or profession, will not be deemed to accrue or arise in India.

## Sec 9(1)(vi) - Royalty payable to NR by

- a) Government ; or
- b) Person who is resident,

**Exception:** where it is payable in respect for transfer of any right or the use of any property or information used or for utilization of services for the purposes of a business or profession carried on by him outside India or for the purposes of making or earning any income from any source outside India ; or

- c) NR in respect of royalty payable in respect of any right, property or Information used or services utilized for the purpose of business or profession carried on by such person in India.

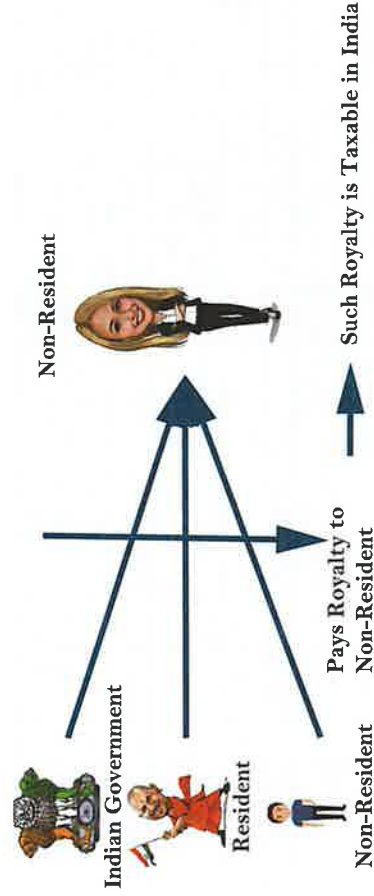

### Note:

1. Lumpsum Royalty made by resident for transfer of all or any right (including grant of license) in respect of computer software supplied by NR manufacturer along with computer hardware under any scheme approved by Govt, shall **not be regarded** as Royalty accrued or arised in India.

2. **Meaning of Royalty:** "Royalty" means Consideration (including any lump sum consideration but excluding any Consideration which would be the income of the recipient chargeable Under the head "CG") for -

- a) The transfer of all or any rights (including the granting of a license) in respect of a patent, invention, model, design, secret formula or process or trade mark or similar property ;
- b) The imparting of any information concerning the working of, or the use of, a patent, invention, model, design, secret formula or process or trademark or similar property
- c) The use of any patent, invention, model, design, secret formula or process or trade mark or similar property;
- d) The imparting of any information concerning technical, industrial, commercial or scientific knowledge, experience or skill; the use or right to use any industrial, commercial or scientific equipment but not including the amounts referred to in section 44BB; the transfer of all or any rights (including the granting of a licence) in respect of any copyright, literary, artistic or scientific work including films or video tapes for use in connection with television or tapes for use in connection with radio broadcasting, including consideration for the sale, distribution or exhibition of cinematographic films; or the rendering of any services in connection with the activities referred to in sub-clauses (i) to (iv), (iva) and (v).

3. **Consideration for use or Right to use computer software is Royalty.** [Explanation 4]

4. **Royalty Includes: Consideration in respect of any right whether or not**

- a) The possession or control of such right, property or information is with the payer;
- b) Such right, property or information is used directly by the payer;
- c) The location of such right, property or information is in India. [Explanation 5]



**5. Meaning of "process":** Process includes & shall be deemed to have always included transmission by satellite (including up-linking, amplification, conversion for down-linking of any signal), cable, optic fibre or by any other similar technology, whether or not such process is secret;

**Sec 9(1)(vii) - FTS** any fees for technical services paid o NR by—

- Government ; or
- Person who is resident,  
Exception: where it is payable in respect for technical services utilised for the purposes of a business or profession carried on by him outside India or for the purposes of making or earning any income from any source outside India ; or
- NR in respect of FTS payable in respect of services utilised for the purpose of business or profession carried on by such person in India.

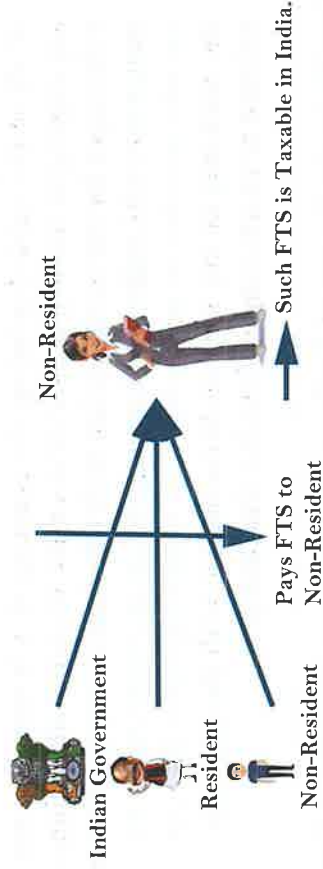

**Explanation 2 - "Fees for technical services"** means any consideration (including any lump sum consideration) for rendering of any managerial, technical/consultancy services (including provision of services of technical/other personnel) but does not include consideration for any construction, assembly, mining or like project undertaken by the recipient or consideration which would be income of the recipient chargeable under the head "Salaries"

**Sec 9(1)(viii) - Income** arising outside India, being any sum of money paid on/after the 5th day of July, 2019 by a person resident in India to non-resident, not being a company, or to a foreign company.

## Circular 13/2017

Salary accrued to NR sea farer for service rendered outside India on a foreign going ship (with Indian flag/not) shall be not included in Total Income nearly because the salary is credited in NRE a/c with Indian Bank.

## Unsolved Questions

### P.1 Based on concept of Total Income

Mr. R & Mr. S are brothers and they earned the following incomes during the FY Mr. R settled in Canada in the year 2006 and Mr. S settled in Delhi. Compute the total income for the assessment year.

Particulars	For R	For S
Interest on Canada Development Bonds (only 50% of interest received in India)	35,000	40,000
Dividend from British company received in London	28,000	20,000
Profit from a business in Nagpur, but managed directly from London	1,00,000	1,40,000
Short term capital gain on sale of shares of an Indian company received in India	60,000	90,000
Income from a business in Chennai	80,000	70,000
Fees for technical services rendered in India, but received in Canada	1,00,000	-
Interest on savings bank deposit in UCO Bank, Delhi	7,000	12,000
Agricultural income from a land situated in GOA	56,000	45,000
Rent received in respect of house property at Bhopal	1,00,000	60,000
Life insurance premium paid	-	30,000

### P.2 Based on Determination of Residential Status

Mr. Alok, Indian citizen & a member of crew of Singapore bound Indian ship engaged in carriage of passengers in international traffic departing from Mumbai port on 6th June'23 From following details for P.Y. determine RS of Mr. Alok for AY assuming that his stay in India in the last 4 PY is 400 days & last seven previous years is 750 days:  
Date entered into CDC 6th June 2023  
Date entered into signing off the ship 9th Dec 2023.

### P.3 Based on Computation of Gross Total Income

Mr. Shravan, citizen of India & employee of CG left India for first time on 11.02.2023 due to transfer to Australia for assignment. He did not visit India any time during PY. From following particulars of his income for FY 2023-24, compute his gross total income for A.Y.

Particulars	Rs.
Salary	6,10,000
Foreign Allowance (paid by the govt for rendering services in Australia)	4,55,000
Interest on fixed deposit from bank in India	1,10,000
Income from agriculture in Malaysia	3,50,000
Income from house property in Malaysia	2,25,000

### P.4 Based on Tax liability in India

Poulomi, a chartered accountant, is presently working in a firm in India. She has received an offer for the post of Chief Financial Officer from a company at Singapore. As per the offer letter, she should join the company at any time between 1st Sep, 2023 and 31st Oct, 2023. She approaches you for your advice on the following issues to mitigate her tax liability in India:

- (i) Date by which she should leave India to join the company;
- (ii) Direct credit of part of her salary to her bank account in Kolkata maintained jointly with her mother to meet requirement of her family
- (iii) Period for which she should stay in India when she comes on leave.



# Chapter 3

## AGRICULTURE INCOME

Sr No	Particulars	Pg No
1	Basics of Agriculture Income	3.2
2	Agriculture Income	3.2
3	Sec 2(1A) Agricultural Operation	3.2
4	Rule 7 & 8 Composite Agriculture Income	3.2
5	Composite Agriculture Other Income	3.2
6	Method of Aggregation / Partial Integration	3.2

“



Don't  
CARE  
what they  
will think

”

## Basics of Agriculture Income

- > Agriculture income is defined u/s 2[1A].
- > Agricultural Income is exempt from income tax u/s 10 (1), but income tax act indirectly collects tax on agricultural income
- > **Agriculture Income** Fall within the state List Entry no 46, Hence shall be levied and collected by SG.
- > **Sec 14A** Where any expenditure is incurred in relation to exempt Income the same shall not be allowed as deduction.

## Sec 2(1A) Agriculture Income

**Agriculture Income** means :

- Any Rent or Revenue Derived from an Agriculture land situated in India & used for agriculture purpose
- Income from agricultural operation.
- Income from farm house or farm land.
- Income from Nursery, sampling, seedling. [Expl.3]

## Agriculture Operation

The word agricultural operation is not defined in the act, however it has been considered by court in **Raja benoy Sahay Case** which has provided:

**Mere Basic Operation** - It's Agriculture Income

**Mere Subsequent Operation** - Non-Agriculture Income

**Subsequent operation together with basic** - Agriculture Income

**Basic Operation** : It means application of human skill & labour upon the land, prior to germination, e.g. Tilling of land, sowing of seeds, planting etc.

**Subsequent Operation** : Means operations which fosters growth & Preserve Produce For rendering produce fit for sale in market, & which are performed after the produce sprouts from the land.

AI  
3.2

## Rule 7 & 8 - Composite Agriculture Income

Rule	Content	Agriculture	Non Agriculture
7A	Growing and manufacturing rubber (Latex)	65%	35%
7B	Growing and manufacturing coffee grown & Cured	75%	25%
7B	Growing and manufacturing coffee grown, cured, roasted and grounded	60%	40%
8	Growing and manufacturing Tea	60%	40%

## Composite Agriculture Other Income

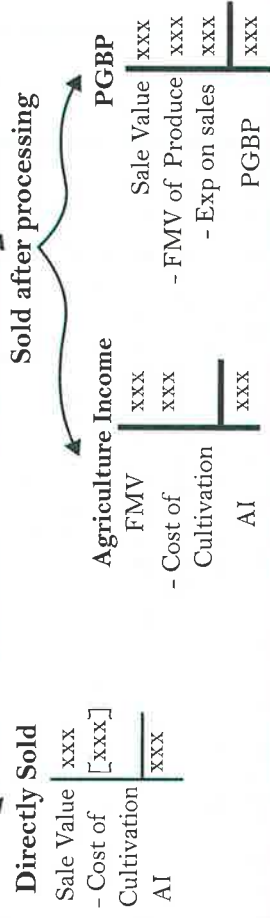

## Method of Aggregation/Partial Integration

**Applicability:** Applicable only to individuals, HUF, AOP & BOI, AJP & not applicable to firms and companies

Minimum agricultural income: Should exceed ₹5000

Other income: Should exceed ₹250000/300000/500000

Step 1: Agricultural Income + Non Agricultural Income	xxx
Step 2: Tax on Step 1	xxx
Step 3: Agricultural Income + Basic Exemption Limit	xxx
Step 4: Tax on Step 3	xxx
Step 5: Difference of tax [Step 2- Step 4]	xxx
Step 6: Add Surcharge/Less Rebate, Add HEC	xxx
Step 7: Final Tax Liability	xxx

If an Individual opts to be taxed u/s 115BAC, the exemption shall be limited to ₹ 3,00,000 whether such individual is less than or more than 60 years old.



# Chapter 4

## INCOME FROM HOUSE PROPERTY

Sr No.	Particulars	Pg No
1	Charging Section	4.2
2	Composite Rent	4.2
3	Income from House Property outside India	4.2
4	Gross Annual Value	4.2
5	Municipal/Property/Corporation Tax	4.2
6	Deductions from Annual Value	4.3
7	Sec 25 Deduction of Interest not allowed in certain cases	4.3
8	Sec 23(2) Computation - Self Occupied property	4.3
9	Sec 23(4) More than 2 Self occupied property	4.4
10	Sec 23(1)(c) Let out Property Vacant for Whole Year	4.4
11	Sec 23(3) Property let out for part & self occupied for part year	4.4
12	Property a portion of which is let out & portion is self occupied	4.5
13	Sec (1)(c) Let out property kept vacant for part of year	4.5
14	Sec 25AA, 25B Recovery of unrealized rent & arrears	4.5
15	Adjustment for Unrealised Rent	4.5
16	Sec 26 Co-Owned Property	4.5
17	Sec 27 Deemed Ownership	4.6
18	Unsolved Questions	4.6

“

**Whether You Think You Can  
Or Think You Can't, You're Right**

”



## Sec 22 Charging Section

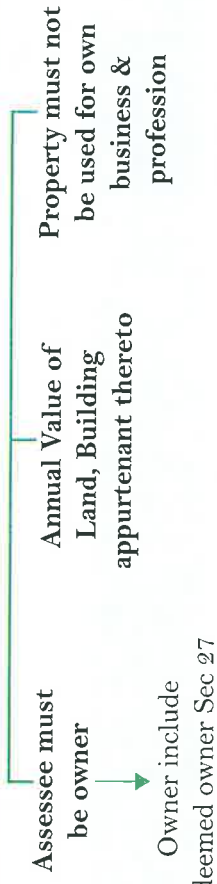

Income under this head may be charged irrespective of income actually received or not

### Composite Rent

If letting of such property is separable	Letting is the main business	a) Income from property- "house property" b) Income from other asset- "PGBP"
	Letting is not the main business	a) Income from property- "house property" b) Income from other asset- "Other sources"
If letting of such property is not separable	Letting is the main business	Entire income will be taxable under "PGBP"
	Letting is not the main business	Entire income will be taxable under "Other sources"

\* Except the case where letting out is for the purpose of carrying on the business in the efficient manner and letting is not the main business.

### Income From HP Outside India

Assessee is ROR	Assessee is RNOR/NR
Taxable in India whether property is in India or Outside India	Taxable in India Only if rent is received in India

HP  
4.2

CA CS VIJAY SARDA +91 8956651954

## Gross Annual Value

GAV shall be higher of RER or ARR

<b>Reasonable Expected Rent :</b>	
Step 1 : Municipal Value	xxx
Step 2 : Fair Rent	xxx
Step 3 : Expected Rent (Higher of Step 1/2)	xxx
Step 4 : Standard Rent	xxx
Step 5 : RER (lower of Step 3/4)	xxx
Actual rent received or receivable Actual rent for let out period	(xxx)
Less: Unrealized Rent Subject to conditions of Rule 4	(xxx)
ARR	xxx

<b>Municipal Value</b>	This is value as determined by the municipal authorities for levying municipal taxes on house property.
<b>Fair Rent</b>	Fair rent is the rent which a similar property can fetch in the same or similar locality
<b>Standard Rent</b>	The standard rent is the maximum rent which can be collected by landlord. This is fixed under Rent control act
<b>Unrealized Rent</b>	Rent due from tenant but not received. Deduction is allowed is condition is satisfied if nothing is mentioned assume that condition is satisfied.

RER cannot exceed expected Rent: (SC) & Amolak Ram Khosla vs. CIT [1981]

# Unrealised rent can also be reduced from GAV

## Municipal/Property/Corporation Tax

<b>Conditions for Benefit</b>	a) It should be Borne by Assessee (Not Tenant). b) It should be actually paid during the year.
<b>Deductions</b>	Paid for PY in the current year - Allowed Paid for Current Year - Allowed Advance Paid - Allowed (Since it is disputed write Note)
<b>Other Benefit</b>	Benefit for Sewerage Tax and Water Tax Also Available
<b>Paid outside India</b>	Allowed as per CIT v. R. Venugopala Reddiar (Mad.)
<b>Adjustments</b>	Given in Cash : Take Actual Amount % is given: Take % of Municipal Value and Not of GAV

www.ekatvamacademy.com/www.vlearnclasses.com



## Sec 24 Deduction From Annual Value

<b>Standard Deduction</b>	<p>a) 30% of NAV                      b) Available only if NAV is Positive.                      c) If standard deduction is available deduction for other expenses are not available eg: Repairs, Insurance.</p> <p>a) Deduction is available on Accrual Basis.                      b) Interest on unpaid interest is not allowed as deduction under this sec.                      c) Any brokerage or commission paid for raising such loan is not allowed.                      d) Interest on new loan taken to repay original loan is considered as loan taken for such acquisition, construction, etc. (Refer CBDT Circular No. 28 dated 20-8-1969).                      f) Sec 80EE Provides additional benefit Out of Gross Total Income.                      g) Deduction = 1/5th of Pre construction + 100% of Post Construction.                      Post Construction interest - 100% allowed as deduction                      Pre Construction Interest - 1/5th of Total Interest Paid during pre construction period</p> <p style="text-align: center;"><b>Pre Construction Period</b></p> <p>a) <b>Repayment Precedes Construction</b>      Date of Borrowing to date of Repayment</p> <p>b) <b>Construction precedes Repayments</b>      Date of Borrowing to 31st March Prior to date of Completion.</p>
---------------------------	---

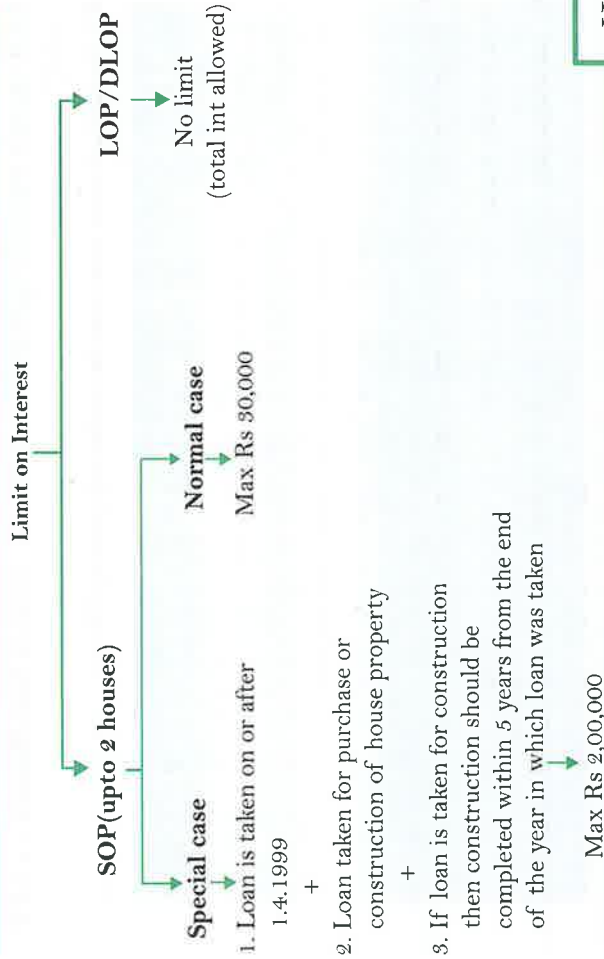

**Under default tax regime u/s 115BAC** - There would be no deduction on account of interest or loan u/s 24(b) under default tax regime u/s 115BAC in respect of property referred to in sec 23(2) i.e self Occupied or unoccupied property [FA 2023]

## Sec 25 Deduction of Interest not Allowed in Certain Cases

Interest chargeable under this Act which is payable outside India shall not be deducted if:

- Tax has not been paid or deducted from such interest and
- There is no person in India who may be treated as an agent u/s 163.

## Sec 23(2) Computation - SOP

### Conditions:-

- The property was not let out for any part of the year
- No other benefits has been derived from the property
- Number of self occupied property shall not exceed 2
- There would be no deduction on account of interest on loan u/s 24(b) under default tax regime u/s 115BAC in respect of the property referred to in sec 23(2) i.e., self-occupied or unoccupied property [FA 2023]

Particulars	₹
Annual value u/s 23(2)	Nil
Less:- Municipal tax actually paid	Nil
NAV	Nil
Less:- Deduction u/s 24	Nil
a) Standard Deduction	
b) Interest on borrowed capital	(xxx)
<b>Conditions:-</b>	
1. Upto Rs. Maximum of ₹200000 [Aggregate Amount of Deduction]	
a. Loan is taken for acquisition or construction	
b. After 1.4.1999	
c. Acquisition or construction is complete within 5 years from the end of financial year in which capital is borrowed.	
2. Upto maximum of ₹30000 [Aggregate Amount of Deduction]	
a. If condition given in 1 is not satisfied	
b. Loan is taken for repairs and maintenance	
Loss from House Property	(xxx)

## Sec 23(4) More Than 2 SOP

Particulars	Option 1			Option 2		
	F1 SOP	F2 SOP	F3 DLOP	F1 SOP	F2 DLOP	F3 SOP
GAV	Nil	Nil	Xxx	Nil	Xxx	Nil
Less: Municipal tax actually paid	Nil	Nil	(xxx)	Nil	(xxx)	Nil
NAV	Nil	Nil	Xxx	Nil	Xxx	Nil
Less: Deduction Standard deduction	Nil	Nil	(xxx)	Nil	(xxx)	Nil
Interest on borrowed capital	(xxx) [limited]	(xxx) [limited]	(xxx) [unlimited]	(xxx) [limited]	(xxx) [unlimited]	(xxx) [limited]

Particulars	Option 3		
	F1 DLOP	F2 SOP	F3 SOP
GAV	Xxx	Nil	Nil
Less: Municipal tax actually paid	(xxx)	Nil	Nil
NAV	xxx	Nil	Nil
Less: Deduction Standard deduction	(xxx)	Nil	Nil
Interest on borrowed capital	(xxx) [unlimited]	(xxx) [limited]	(xxx) [limited]

**Romance** - Choose the option which has lower taxable income or higher loss

### Notes -

- This option can be changed year after year in a manner beneficial to the assessee.
- In case of deemed let-out property, the Annual value (i.e. reasonable expected rent) shall be taken as the GAV.

The **Maximum Interest of both Self occupied property cannot exceed 2,00,000/30,000**

## Sec 23(1)(c) Let Out Property Vacant for Whole Year

Particulars	₹
GAV	Nil
Less: Municipal tax actually paid by the owner	(xxx)
NAV	(xxx)
Less: Deduction Standard deduction	Nil
Interest on borrowed capital	(xxx)
Income from House Property	(Xxx)

Where the property consisting of any building or land appurtenant thereto is held as stock-in-trade and property or any part of the property is not let during the whole or any part of the PY, the annual value of such property or part of the property, for period up to 2 year from end of financial year in which the certificate of completion of construction of property is obtained from the competent authority, shall be taken to be nil.

## Sec 23(3) Property Let Out for Part & Self Occupied for Part Year

Income shall be calculated for the whole year as deemed let out property.

Particulars	₹
GAV	Xxx
Less: Municipal tax actually paid by the owner for PY	(xxx)
NAV	xxx
Less: Deduction	(xxx)
a) Standard deduction	(xxx)
b) Interest on borrowed capital (Unlimited)	(xxx)
Income from House Property	Xxx



## Property a Portion of which is Let Out & Portion Self Occupied

There is no need to treat the whole property as a single unit for computation of income from house property

Particulars	LOP	SOP
GAV	xxx	Nil
Less: Municipal tax actually paid by the owner for the whole year	(xxx)	Nil
NAV	(xxx)	Nil
Less: Deduction Standard deduction	(xxx)	
Interest on borrowed capital	(xx)(unltd)	Nil
Income from House Property	xxx	xxx(ltd)

Make working note for this problem compulsory & divide on the basis of proportion.

### Sec 23(1)(c) Let Out Property Kept Vacant for part of Year

Particulars	₹
Step 1 : RER	xxx
Step 2 : ARR (Excluding unrealized Rent) Higher shall be GAV	(xxx)
Step 3 : AR	xxx
Less : Municipal tax actually paid	
NAV	(xxx)
Deduction u/s 24	(xxx)
1. Standard deduction @ 30%	(xxx)
2. Interest on borrowed capital	(xxx)
Income from house property	xxx

AR > RER  
AR = GAV

only due to vacancy  
AR = GAV

RER > AR  
other reason  
RER (-) loss due to vacancy = GAV

HP  
4.5

### Note:

- Some authors also reduce loss due to vacancy from RER increase RER is greater than AR because of other reason
- Income tax Returns, however permit deduction of unrealised rent from gross annual value, if this view is taken the unrealised Rent should be deducted only after computing gross annual value**

### Sec 25AA, 25B Recovery of Unrealized Rent & Arrears

Unrealized rent	Arrears of rent
a) Taxable in the hands of the assessee whether he is the owner of that property or not.	a) Taxable in the hands of the assessee whether he is the owner of that property or not.
b) Taxable as income of the PY in which he recovers the unrealized rent.	b) Taxable as income of the year in which he receives the arrears of rent.
c) 30% of the amount of arrears shall be allowed as deduction.	c) 30% of the amount of arrears shall be allowed as deduction.
d) Unrealized rent means the rent which has been deducted from actual rent in any previous year for determining annual value.	d) Arrears of rent are in respect of rent not charged to income-tax for any PY.

### Adjustment for Unrealised Rent

Generally Unrealised rent is deducted from Actual rent received (ARR) or receivable however Income tax Return however permits deduction of unrealised from GAV (Gross Annual Value) if this view is taken then Unrealised rent should be deducted only after computing GAV.

### Sec 26 Co-Owned Property

#### Following points should be noted:

Where property is owned by two or more persons, whose shares are definite & ascertainable, then the income from such property cannot be taxed as income of an AOP.

#### Co-owned Property

Used as SOP

Used as LOP

Both can claim SOP benefits & both are allowed deduction of IOBC upto 30,000 / 2L

Step 1 : Calculate HP as if no co-ownership  
Step 2 : Divide the final income in appropriate ratio

## Sec 27 Deemed Ownership

As per section 27, the following persons, though not legal owners of a property, are deemed to be the owners for sec 22 to 26--

a. Transfer to Spouse for Inadequate Consideration

**Exception:** Transfer to spouse in connection with an agreement to live apart, the transferee will be the owner of the house property

b. Transfer to a minor child for Inadequate Consideration

**Exception:** In case of transfer to a minor married daughter, the transferor is not deemed to be the owner.

c. Holder of an impartible estate which is not legally divisible

**Example:** Transfer by Mr. Raja who is one of the ex-Rulers of former Princely State.

d. Member of a co-operative society etc to whom a building or part thereof is allotted or leased under a House Building Scheme of a society/company/association

e. Person in possession of a property this would include cases where the :

- i) Possession of property has been handed over to the buyer
- ii) Sale consideration has been paid or promised to be paid to seller by the buyer
- iii) Sale deed has not been executed in favor of buyer, although certain other documents like power of attorney/agreement to sell/will etc. have been executed. In above case, buyer would be deemed to be owner of property although not registered in his name.

f. Lease for more than 12 years.

Nature of Exemption/Deduction Relating to Head HP	New System	Existing system
Deduction of Municipal tax from GAV	✓	✓
Standard deduction u/s 24(a) from NAV	✓	✓
interest deduction u/s 24(b) from NAV	✓	✓
(a) Let out properties u/s 23(1)	x	✓
(b) Self residential Property u/s 23(2)	✓	✓
(c) Property which is stock in trade u/s 23(5)	x if related to dis-allowed & exempt	✓
Set off of brought forward House Property losses & brought forward depreciation from Current year House Property income	x	✓
Set off current year House Property loss from other heads	x	✓

## Unsolved Questions

### P.1. Based on concept of SOP

Ganesh has three houses, all of which are self-occupied. The particulars of the houses for the P.Y. 2023-24 are as under:

Particulars	House I	House II	House III
Municipal valuation p.a.	3,00,000	3,60,000	3,30,000
Fair rent p.a.	3,75,000	2,75,000	3,80,000
Standard rent p.a.	3,50,000	3,70,000	3,75,000
Date of completion/purchase	31.3.2000	31.3.2002	01.4.2016
Municipal taxes paid during the year	12%	8%	6%
Interest on money borrowed for repair of property during the current year	-	55,000	
Interest for current year on money borrowed in April, 2016 for purchase of property			1,75,000

Compute Ganesh's income from house property for A.Y. 2024-25 and suggest which houses should be opted by Ganesh to be assessed as self-occupied so that his tax liability is minimum.



## P2. Based on Concept of IOBC

Mr. Krishna owns a residential house in Delhi. The house is having two identical units. First unit of house is SO by Mr. Krishna & another unit is rented for ₹12,000pm. The rented unit was vacant for 3 months during the year. The particulars of house for the PY 2023-24 are as under & compute income from HP for AY 24-25

Standard Rent - ₹2,20,000; Municipal valuation - ₹2,44,000  
Fair Rent - ₹2,35,000; Municipal taxes paid -- 12% of  
Municipal Valuation Light & water charges - ₹800 P.M; Interest on borrowed Capital - ₹2,000 p.m. Insurance charges - ₹3,500 p.a.;  
Painting expenses - ₹16,000 p.a

Period prior to	
1.4.2023 to 30.6.2023	49,200
1.7.2023 to 31.03.2024	50,800
	1,51,300

He had a house property in Bangalore, which was sold in March'22. In respect of this house, she received arrears of rent of ₹60,000 in March'24. This amount has not been charged to tax earlier. Compute income chargeable from HP for AY 24-25, exercising the most beneficial option available.

## P3. Based on SOP + Property kept vacant

Mr. X owns a residential house in Mumbai. The house is having 2 identical units. First unit of the house is self occupied by Mr. X & another unit is rented for ₹8,000 p.m. The rented unit was vacant for 2 months during the year. The particulars of house for the PY 23-24 are as under:

Standard rent ₹1,62,000 p.a. ; Municipal valuation - ₹1,90,000 p.a.  
Fair rent ₹1,85,000 p.a. ; Municipal tax - 15% of municipal valuation  
Light and water charges ₹500 p.m ; interest on borrowed capital-  
₹1500 p.m. Lease money ₹1200 p.a. ; Insurance charges ₹3000 p.a.  
Repairs ₹12,000 p.a.

Compute income from house property of Mr. X for the A.Y. 24-25.

## P4. Based on LOP + Unrealized Rent

Mr. Anand sold his residential house property in March, 2023. In June, 2023, he recovered rent of ₹ 10,000 from Mr. Gaurav, to whom he had let out his house for two years from April 2017 to March 2019. He could not realise two months rent of ₹ 20,000 from him and to that extent his actual rent was reduced while computing income from house property for A.Y. 2019-20. Further, he had let out his property from April, 2019 to February, 2023 to Mr. Satish. In April, 2021, he had increased the rent from ₹ 12,000 to ₹15,000 per month and the same was a subject matter of dispute. In September, 2023, the matter was finally settled and Mr. Anand received ₹ 69,000 as arrears of rent for the period April 2021 to February, 2023. Would the recovery of unrealised rent and arrears of rent be taxable in the hands of Mr. Anand, and if so in which year?

## INCOME FROM SALARY

Sr No	Particulars	Pg No
1	Sec 15 Charging Section	5.2
2	Fully Taxable Part of Salary	5.2
3	Partly Exempt Allowances Sec 10(14)	5.2
4	Allowances [FA 2023]	5.3
5	Sec 10(13A) House Rent Allowance	5.3
6	Sec 16 Deductions	5.3
7	Sec 10(10) Gratuity	5.4
8	Sec 10(10A) Pension	5.4
9	Sec 10(10B) Retrenchment Compensation	5.4
10	Sec 10(10C) Voluntary Retirement	5.5
11	Sec 10(10AA) Leave Salary	5.5
12	Specified & Non Specified Employee	5.5
13	Rule 3(1) PERK : Valuation of Residential Accommodation	5.6
14	Rule 3(2) PERK : Valuation of Motor/Other Vehicle	5.6
15	Gift From Employer	5.7
16	Perk : Credit Card Facility	5.7
17	Perk : Club Facility	5.7
18	Perk : ESOP	5.7
19	Approved Super Annuation Fund	5.7
20	Perk : Use of Movable Assets	5.8
21	Sale of Movable Assets	5.8
22	Perk : Interest Free or Concessional Loan	5.8
23	Free Food	5.8
24	Perk : Taxable Only in Case of Specified EE	5.8
25	Provident Fund	5.10
26	Fully Exempted Perks	5.11
27	Any annual accretion of interest dividend In Fund	5.11

Sr No	Particulars	Pg No
28	Limit On Interest Credited On Contribution By	5.12
29	Such Employee	5.12
30	Relief u/s 89(1) read with Rule 21A	5.12
31	Impact of Sec 115BAC Under Salaries	5.13
32	Unsolved Questions	5.13

### IMPORTANT AMENDMENTS/ NOTIFICATIONS/CIRCULARS

Sr No.	Particulars	Pg No
1	Any annual accretion of interest dividend In Fund	5.11
2	Limit On Interest Credited On Contribution	5.10



“  
**Bachooo**  
**SALARY**  
**BOLE**  
**TOHHHHHH**  
”

Salary  
5.1



## Sec 15 Charging Section

### CHARGEABLE INCOME :

Where there exists a relationship of employer and employee. Where an individual is bound to follow the instructions of other it is said that there exists a relationship of ER and EE.

### WHEN IS SALARY CHARGED TO TAX :

- > Salaries charged to tax either on DUE or RECEIPT whichever matures earlier
  - > Salary is taxable at a place where services are rendered.
- Exception :** Following salaries taxable on receipt basis
- a. Advance Salary
  - b. Bonus
  - c. Salary in lieu of notice period
  - d. Arrears of Salary

### COMPUTATION :

#### Basic + Taxable Allowance + Taxable Perquisite

# Salary includes The contribution made by the CG in the PY, to the Agniveer Corpus Fund account of an individual enrolled in the Agnipath Scheme referred to in sec 80CCH. [FA 2023]

## Fully Taxable Part of Salary

- a. Basic
- b. Bonus
- c. Fees
- d. Advance/Arrears
- e. Commission
- f. Leave Encashment
- g. Uncommuted Pension (Monthly pension)

## Partly Exempt Allowances Sec 10(14)

Name of Allowance	Nature of allowance	Exemption
<b>Allowance for transport Employee</b>	Any allowance granted to an employee working in any transport system to meet his personal expenditure during his duty performed	<b>Lower of :</b> i) 70% of such allowance; or ii) ₹10,000 pm
<b>Children Education Allowance</b>	Any allowance given for children education of employee(s). Deduction is available even if not spent.	₹100 pm per child, max upto 2 children
<b>Hostel Expenditure Allowance</b>	Any allowance given for meeting hostel expenditure of child/children of employee(s)	₹500 pm per child, max upto 2 children.
<b>Transport allowance</b>	Transport allowance granted to an employee, other than the employee working in any transport system, to meet his expenditure for the purpose of commuting between the place of his residence and the place of his duty. <i>This would be available in both regimes. [FA 23]</i>	In case EE is blind/handicapped, ₹3200 pm. [Still Available]
<b>Underground allowance</b>	Underground allowance is granted to an employee who is working in unnatural climate in underground.	₹800 pm
<b>High altitude allowance</b>	This allowance granted to the member of the armed forces operating in high altitude areas.	<b>Exemption :</b> a) For altitude of 9,000 to 15,000 ft. ₹1060pm b) For altitude above 15,000 ft. ₹1600pm
<b>Tribal Area</b>	The tribal areas of Madhya Pradesh, Tamil Nadu, Uttar Pradesh, Karnataka, Tripura, Assam, West Bengal, Bihar & Orissa.	₹200 pm

## Allowances [FA 2023]

Allowance is a fixed monetary amount paid by the employer to employee for meeting some particular requirement connected with the service rendered by the employee. From income tax point of view, there are 3 types of such allowances which as under:

1. Taxable allowances,
2. Allowances exempt upto specified limit,
3. Fully exempt allowances.

Fully Taxable under both regimes	Fully Taxable under default tax regime/ Partly Exempt under the optional tax regime	Fully Exempt only under the optional tax regime
(i) Entertainment Allowance (ii) Dearness Allowance (iii) Overtime Allowance (iv) Fixed Medical Allowance (v) City Compensatory Allowance (to meet increased cost of living in cities) (vi) Interim Allowance (vii) Servant Allowance (viii) Project Allowance (ix) Tiffin/Lunch/Dinner Allowance (x) Any other cash allowance (xi) Warden Allowance (xii) Non-practicing Allowance (xiii) Transport allowance to employee other than blind/deaf and dumb/orthopedically handicapped employee	(i) House Rent Allowance [u/s 10(13A)] (ii) Special Allowances [u/s 10(14)] Except - (a) Travelling allowance (b) Daily allowance (c) Conveyance allowance (d) Transport allowance to blind/deaf and dumb/orthopedically handicapped employee Note: The exceptions in (a) to (d) above are partly exempt under both the tax regimes.	(i) Allowances to High Court Judges (ii) Salary and Allowances paid by the United Nations Organization (iii) Sumptuary allowance granted to High Court or Supreme Court Judges Note : In cases (i) and (iii) above, the respective Acts provide for such exemption, notwithstanding anything contained in the Income-tax Act, 1961. In case (ii), exemption is provided under the respective Act, notwithstanding anything to the contrary contained in any other law.
<b>Fully Exempt under both tax regimes</b>		Allowance granted to Government employees outside India [Sec 10(7)]

## Sec 10(13A) House Rent Allowance

**Exemption is not available if:**

- a) Accommodation is owned by him.
  - b) If he has not paid the rent for accommodation.
- If Assessee opts for 115BAC then HRA exemption not available. HRA will become totally taxable.

**Exemption is lower of :**

- i) Actual amount
- ii) Rent Paid (-) 10% of salary
- iii) 50% of salary in respect of the relevant period, if such accommodation is situated in Mumbai, Calcutta, Delhi or Chennai (40% of salary if it is situated at any other place)

**Notes :**

**Salary = Basic + DA(R) + Commission (T).**

If there is change in any factor namely Salary, HRA, Period, place of business etc. HRA needs to be calculated separately. Any Advance Salary shall be excluded for purpose of this calculation. Exemption is also not available if Rent paid is less than 10 % of Salary. The basis for calculation is location of accommodation & not of Service.

**# This is fully taxable under default tax regime [FA 23].**

## Sec 16 Deductions

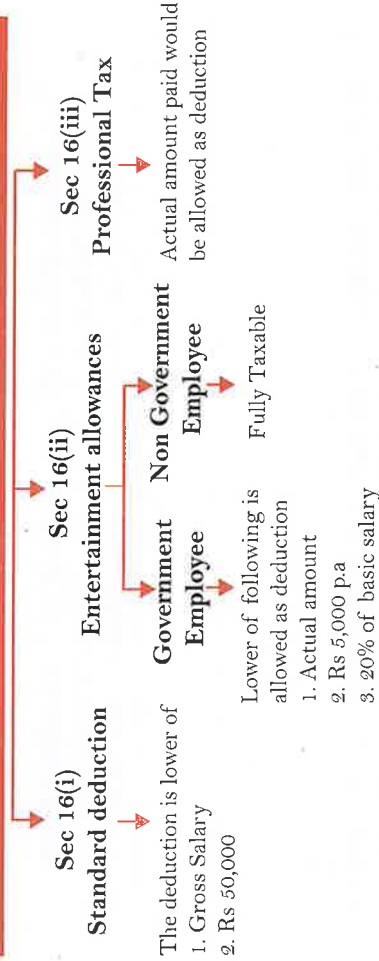

**# U/s 115BAC (default tax regime) standard deduction u/s 16(ia) will be:-**

- a. Amount of salary or
- b. Rs 50000 whichever is lower [FA 2023]



## Sec 10(10) Gratuity

<b>Covered in Gratuity Act</b>	Basic +DA
<b>Not Covered in Gratuity Act</b>	Basic salary + D.A. (R) + commission based on fixed % of turnover.
<b>Average Salary</b>	Avg. monthly salary calculated on basis of avg. salary for 10 M immediately preceding month in which employee has retired. For instance if employee retires on Dec, avg. salary will be calculated till November.
<b>Received from more than 1 employer</b>	While claiming the statutory deduction of ₹20L any amount earlier claimed as deduction shall be reduced from ₹20L.
<b>Relief u/s 89(1)</b>	Available

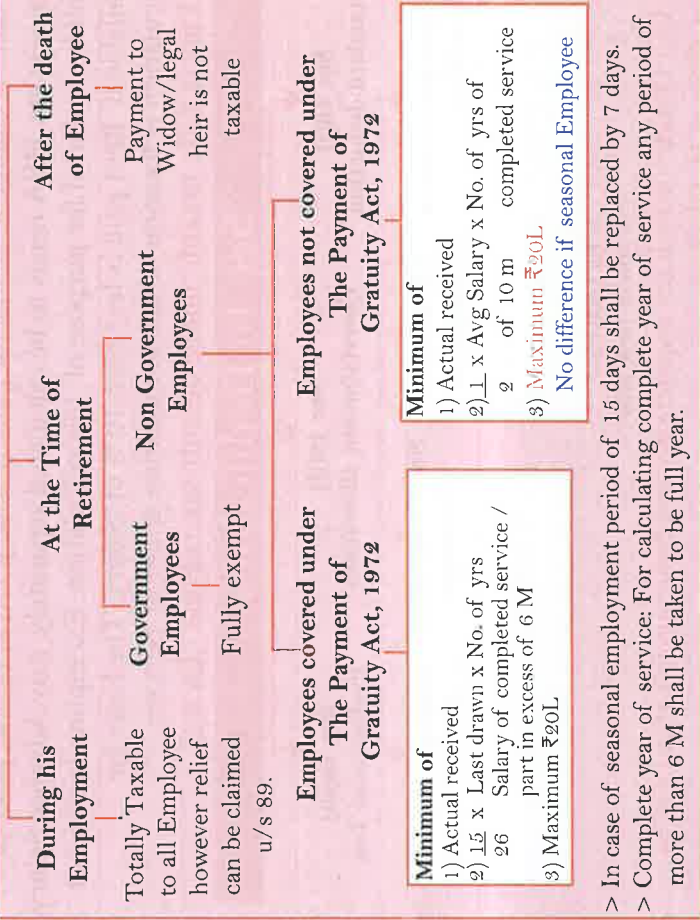

## Sec 10(10A) Pension

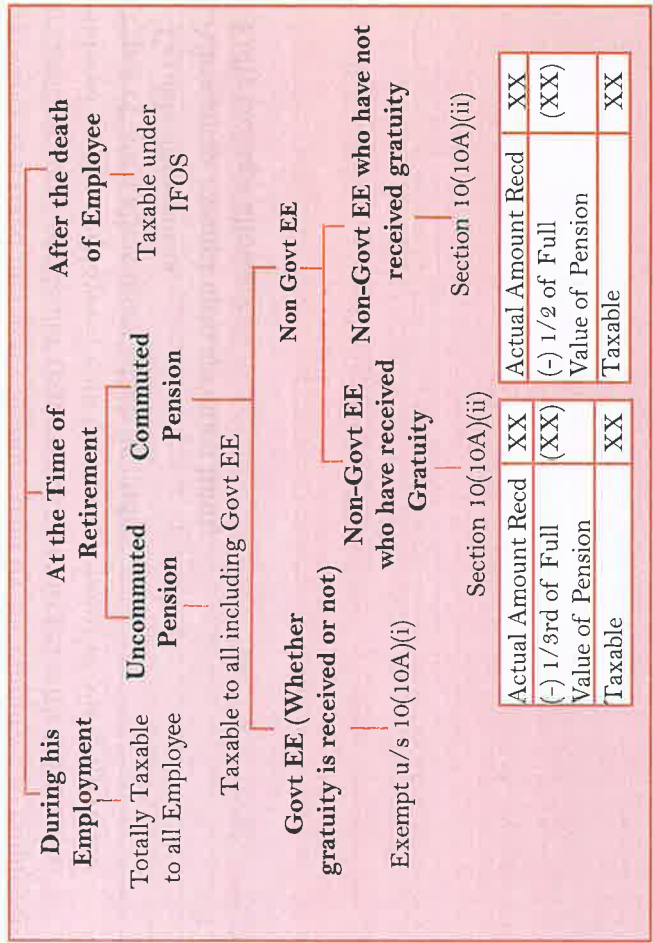

### Notes :

Pension received from UNO is not taxable.  
 Relief u/s 89(1) available for commuted pension.  
**Full Value of Pension = Amount Received % of Commutation**

## Sec 10(10B) Retrenchment Compensation

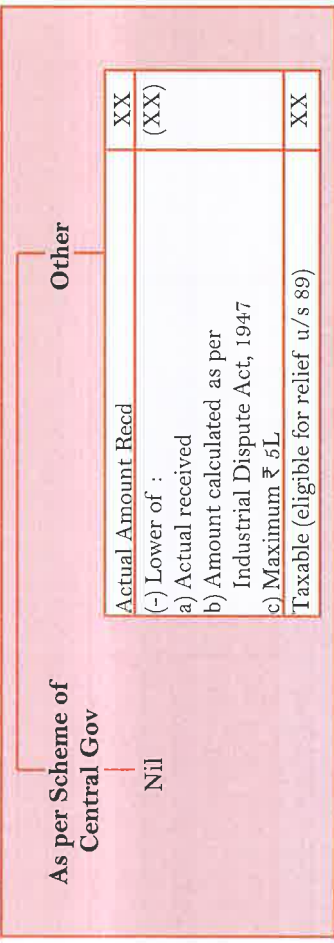

**Notes :**

- > If amount determined as per industrial dispute act is not given:-  
 $15 \times \text{Avg salary of Last 3M} \times \text{No of year of completed service}$   
 $\div$  part thereof in excess of 6 M.
- However as per **Guru Jambeswar Case** instead of 15/26 take 15/30.
- > **Salary for this purpose : Basic+ DA(R)**
- > If retrenchment compensation is received in scheme framed by CG then whole retrenchment compensation is Exempt.
- > Any compensation in excess of above limit will be taxable as salary.

**Sec 10(10C) Voluntary Retirement**

<b>Conditions</b>	(i) 10 years of service or 40 years of age (ii) For all employees (except directors of the company) (iii) Overall Reduction in number of employees (iv) Not to be filled up (v) No same management
<b>Exemption</b>	Actual Amount Recd (-) Lower of : a) Actual Amount b) Rs.500000 c) Amount higher of : i) Last drawn salary x 3 x No of yrs Completed Service. ii) Last Drawn Salary x Balance no of M left for service Taxable

**Notes :**

Deduction under this sec is available only once in lifetime.  
**Salary = Basic + DA (R) + Commission (T).**  
 If assessee claims relief u/s 89(1) for VRC then he cannot claims exemption u/s 10(10C) in that year or any other AY.

**Sec 10(10AA) Leave Salary**

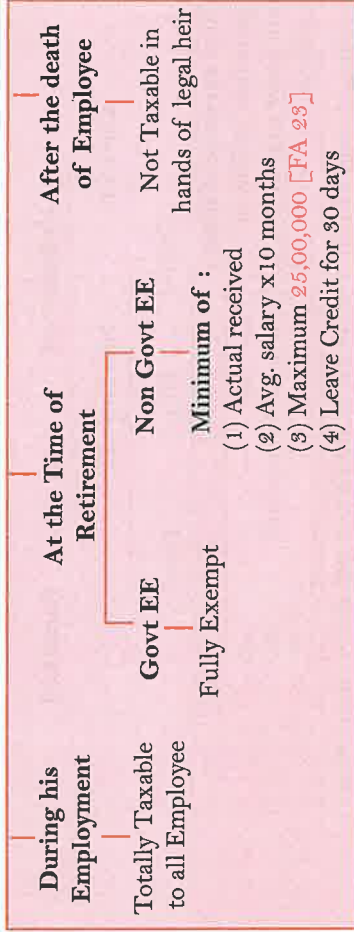

- > Employees are entitled to various types of leave while in service. The leave may either be availed by them or in case not availed, these may either lapse/are allowed to be encashed every year or these are accumulated and encashed after retirement or death.
- > **Salary Means Basic + DA(R) + C (T)**
- > Relief u/s 89(1) available
- > **How to Find out leave Credit :**
  - a) Find out duration of service without any fraction-  
 $12 \text{ yrs} \& 7M = 12 \text{ yrs}$
  - b) **Find out leave allowed:** (Max allowed as per rule 30 days per yr) if period of leave credited is more than 30 days then take 30 days for calculation & it is less than 30 days then same can be taken.
  - c) Period of leave earned = (Leave Credit x Avg Salary) / 30

**Specified & Non Specified Employee**

- If any of the 3 condition is satisfied an employee is treated as specified employee. [17(2)(iii)]
- a. Employee + Director
  - b. Employee + Substantial Interest. S 2(32) An employee holding atleast 20% voting power in a company
  - c. Income from Salary less salary in kind exceeds ₹ 50,000
- If none of the conditions are satisfied then employee is treated as non specified employee.



## Rule 3(1) PERK : Valuation of Residential Accommodation

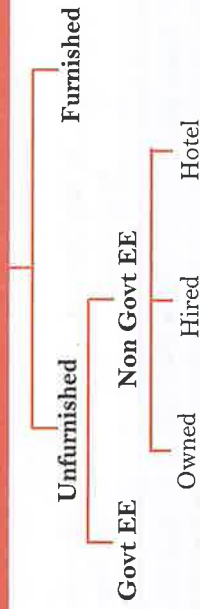

Where accommodation is provided by Union/ State Govt to their employees	<p>License Fees Less: Anything Recovered Perk</p> <p>Population of the city (as per 2001 census) where Accommodation is provided,</p> <table border="1"> <thead> <tr> <th>Population</th> <th>Perk</th> </tr> </thead> <tbody> <tr> <td>Beyond 25 Lakh</td> <td>15%</td> </tr> <tr> <td>Above 10 Lakh- 25 Lakh</td> <td>10%</td> </tr> <tr> <td>Below 10 Lakh</td> <td>7.5%</td> </tr> </tbody> </table>	Population	Perk	Beyond 25 Lakh	15%	Above 10 Lakh- 25 Lakh	10%	Below 10 Lakh	7.5%		
Population	Perk										
Beyond 25 Lakh	15%										
Above 10 Lakh- 25 Lakh	10%										
Below 10 Lakh	7.5%										
Accommodation owned by him	<p><b>Deduction for any amount paid by the employee :</b> The amount so calculated shall be reduced by rent, if any, actually paid by EE</p> <p><b>Lower of :</b> a) 15% of Salary or b) Actual amount paid.</p> <p><b>Deduction for any amount paid by EE :</b> The amount so calculated shall be reduced by rent, if any, actually paid by the employee.</p> <p><b>Salary for such period only:</b> Salary for this purpose should be taken only for the period during which accommodation is occupied by EE</p>										
Provided in Hotel	<table border="1"> <tr> <td>Upto 15 days</td> <td>Nil</td> </tr> <tr> <td>Beyond 15 days</td> <td> <table border="1"> <tr> <td>24% of salary</td> <td>xxx</td> </tr> <tr> <td>Less: Recovered Perk</td> <td>(xxx)</td> </tr> <tr> <td></td> <td>xxx</td> </tr> </table> </td> </tr> </table>	Upto 15 days	Nil	Beyond 15 days	<table border="1"> <tr> <td>24% of salary</td> <td>xxx</td> </tr> <tr> <td>Less: Recovered Perk</td> <td>(xxx)</td> </tr> <tr> <td></td> <td>xxx</td> </tr> </table>	24% of salary	xxx	Less: Recovered Perk	(xxx)		xxx
Upto 15 days	Nil										
Beyond 15 days	<table border="1"> <tr> <td>24% of salary</td> <td>xxx</td> </tr> <tr> <td>Less: Recovered Perk</td> <td>(xxx)</td> </tr> <tr> <td></td> <td>xxx</td> </tr> </table>	24% of salary	xxx	Less: Recovered Perk	(xxx)		xxx				
24% of salary	xxx										
Less: Recovered Perk	(xxx)										
	xxx										

Salary  
5.6

Particulars	₹
Value as Per Unfurnished	xxx
Add: Value of Furniture	xxx
If Owned : 10% of actual Cost	Xx
Hired : Actual Hire Charges	Xx
Less: Anything Recovered	(xxx)
Perk	xxx

### Notes :

1. **Salary: Basic+ DA(R)+ Bonus + Commission + All taxable Allowance**
2. "Accommodation" incl. house, flat, farm house, hotel accommodation motel, service apartment guest house, caravan, mobile home, ship etc.
3. Where an employee is transferred from one place to another & he is provided with an accommodation at new place also. The value of perquisite shall be taken for only one such house having lower value for period not exceeding 90 days. Thereafter, the values of both.

## Rule 3(2) PERK : Valuation of Motor/Other Vehicle

Situation	Use	Tax Treatment
Car owned & maintained by Employer	<b>Official use</b>	Exempt
	<b>Private use</b>	10% of cost OR Actual hire charges (+) Running & Maintenance exp. (-) Amount recoverable
	<b>Partly official partly private</b>	Taxable amount = For/below 1.6 ltr.CC = 1,800 pm Above 1.6 ltr.CC = 2,400 pm (Nothing deductible on account of Amount recovered)
Car owned by Employer & maintained by Employee	<b>Official use</b>	Exempt
	<b>Private use</b>	10% of cost OR Actual hire charges (-) Amount recoverable
	<b>Partly official partly private</b>	Taxable amount = For/below 1.6 ltr.CC = 600 pm Above 1.6 ltr.CC = 900 pm If Chauffeur provided = 900pm (Nothing deductible on account of amount recovered)
Car owned & maintained by Employee	<b>Car owned &amp; maintained by Employee</b>	Nothing is Taxable

Car owned by Employee & maintained by Employer	Official use	Nil	
	Private use	Amount of Expenditure	
Any other automotive owned by Employer	Partly official partly private	Actual Expenditure (-) 1800 pm / 2400 pm (Depending on CC) (-) 900 pm if chauffer is provided Taxable	xxx (xxx)  xxx
	Official use	Nil	xxx
Any other automotive owned by Employer	Private use	Amount of Expenditure	
	Partly official partly private	Actual Expenditure Less: Rs. 900 p.m. (Greater deduction can be allowed if as per official records it is established that expense was for official use)	

1. Month denotes completed month. Any part of M shall be ignored
2. Chauffer is added only if provided.
3. When more than 1 car is provided to EE, otherwise than wholly & exclusively for such car than value of perquisite
4. For 1 car shall be taken as used for partly official & partly for personal

### Gift From Employer

Cost Doesn't Exceed ₹ 5000 pa	Nil
Cost Exceed ₹ 5000 pa	Alternative 1: Followed BY ICAI & Our Class Amount exceeding ₹ 5,000 fully taxable Alternative 2: ICAI Provides an alternative that if it exceed ₹ 5000 only excess portion is taxable

### Perk : Credit Card Facility

Official Purpose	Nil	
Other Purpose	Actual Cost to Employer Less: Recovered Perk	xxx (xxx) xxx
<b>Conditions:</b>		
a) Complete details in respect of such expense are maintained by the employer which may, inter-alia, include date & nature of expense; and		
b) The employer gives a certificate for such expense to the effect that same was incurred wholly & exclusively for the performance of official duty.		

### Perk : Club Facility

Official Purpose	Nil [It should be certified By Employer]	
Given Uniformly to all Employee	Nil	
Corporate Membership for all Employee	Initial Fees	Nil
	Other	Actual Cost Less: Recovered Perk

### Perk : ESOP

FMV on the date of Exercise [-] Amount Recovered

### Approved Super Annuation Fund

EE's Contribution is eligible for deduction u/s 80C ER's Contribution **Less than ₹150,000** : Exempt from Taxable  
**More than ₹150,000** : Chargeable to tax to the extent it exceeds Interest on accumulated balance is exempt from tax

### Overall Cap Limit Introduced By Finance Act 20

The amount or the aggregate of amounts of any contribution made to account of the assessee by the employer :

- (a) In a recognised provident fund;
- (b) In the scheme referred to in sec 80CCD(1); and
- (c) In an approved superannuation fund, to the extent it exceeds ₹7,50,000 in a PY;

> Annual accretion by way of interest, dividend or any other amount of similar nature during the PY to the balance at the credit of fund in any PY computed in such manner as may be prescribed; (refer how to compute Interest ahead)

Salary  
5.7

CA CS VIJAY SARDA  +91 8956651954

www.ekatvamacademy.com/www.vlearnclasses.com



## Perk : Use of Movable Assets

<b>Owned by ER</b>	10% of actual Cost Less: recovered Perk	xxx (xxx) xxx
<b>Hired by ER</b>	Actual Cost to ER Less: recovered Perk	xxx (xxx) xxx
<b>Comp &amp; Laptop</b>	Nil (official/personal use)	

## Sale of Movable Assets

Particulars	Electronics/ Computer	Car	Other Assets
Depreciation Rate	50%	20%	10%
Depreciation Method	WDV	WDV	SLM
Actual Cost	Xxx (xxx)	Xxx (xxx)	Xxx (xxx)
Less: Depreciation for each completed year from date of acquisition	Xxx (xxx)	Xxx (xxx)	Xxx (xxx)
WDV	Xxx (xxx)	Xxx (xxx)	Xxx (xxx)
Less: Sale Value	Xxx	Xxx	Xxx
Perk			

## Perk : Interest Free or Concessional Loan

<b>For Specified Diseases &amp; Loan upto ₹20000</b> Perk: NIL	Loan	Loan Beyond ₹20000		
		<table border="1"> <tr> <td>= / &gt; Than SBI rate as on 1st day of PY.</td> <td>Nil</td> </tr> <tr> <td>Lower than SBI rate as on 1st day of PY.</td> <td>Maximum Outstanding Monthly Bal (i.e. the aggregate outstanding bal for each loan as on last day of each month after EMI) Less: Recovered</td> </tr> </table>	= / > Than SBI rate as on 1st day of PY.	Nil
= / > Than SBI rate as on 1st day of PY.	Nil			
Lower than SBI rate as on 1st day of PY.	Maximum Outstanding Monthly Bal (i.e. the aggregate outstanding bal for each loan as on last day of each month after EMI) Less: Recovered			

## Free Food

> If Assessee opted for 115BAC this benefit is not available.

Tea & Coffee During Office Hours	Provided in Remote Area or Offshore Installation	Other
Nil		Actual Cost to Employer (-) Rs.50 per Meal/day Perk
		xxx (xxx) xxx

> Remote area means an area located at least 40 km away from town where population not exceeding 20,000 based on last published census.

> If no of days is not specified take 300 days in a year.

# This exemption is available only if the employee exercises the option of shifting out of the default tax regime provided u/s 115BAC(1A) [FA 2023]

## Perk : Taxable Only in Case of Specified EE

### GAS / ELECTRICITY / WATER FACILITY

Connection in the name of

<b>Employer : Taxable only to specified EE</b>	<b>Employee -Taxable to all employee</b>
Manufacturing cost Per Unit	Actual Cost to ER
Less: Recovered	Less: Recovered
Taxable	Taxable
xxx (xxx) xxx	xxx (xxx) xxx

### EDUCATION FACILITY

<b>School Maintained by ER</b>	<b>Education cost Reimbursed Cost to ER (-) Recovered</b>
Cost pm doesn't exceed 1000pm	Nil
Cost exceed 1000pm	Cost in similar school (-) Recovered

Salary  
5.8

CA CS VIJAY SARDA +91 8956651954

www.ekatvacademy.com/www.vlearnclasses.com

## TRAVEL FACILITY

Cases	Tax	
	Rail/Air	NIL
If employer is engaged in transportation business	Other	Amount charged from public for such facility is taxable in the hands of specified employee (-) Recovered
In any other case		Actual cost of employer for such facility is taxable in the hands of all employees (-) Recovered.

Leave travel concession 10(5) not available if opted for 11.5BAC

## MEDICAL FACILITY

The prerequisite in respect of medical facility is generally taxable only in case of 'specified employees'. Where however, bills are issued in the name of the employee & the employer makes payment thereof, then it is a perquisite taxable in the hands of all employees

In India	Exempt	1) Treatment in Hospital Maintained by Employer 2) Government Hospital 3) Approved Hospital 4) Any health Insurance/ Group Insurance			
	Taxable	Reimbursement in Private Hospital is Fully Taxable			
Outside India	Medical Treatment	Exempt upto an amount specified by RBI			
	Stay Abroad	Exempt upto an amount specified by RBI			
	Travel	<table border="1"> <tr> <td>Gross total Income upto ₹L</td> <td>Nil</td> </tr> <tr> <td>Gross total Income beyond ₹L</td> <td>Total taxable</td> </tr> </table>	Gross total Income upto ₹L	Nil	Gross total Income beyond ₹L
Gross total Income upto ₹L	Nil				
Gross total Income beyond ₹L	Total taxable				

## LEAVE TRAVEL CONCESSION

Exemption under this sec is available to an individual



Journey Performed	Exempt upto		
By Air	Air economic class fare of shortest route		
By Rail	Air Conditioned 1st class fare of shortest route		
Others	Connected By Rail Route	Air Conditioned 1st class fare of shortest route	
	Not Connected by Rail Route	Public Transport available	First class/deluxe class fare, as the case may be, on such transport.
		Not Available	Amount equivalent to air-conditioned 1st class rail fare, for the distance of the journey by the shortest route, as if journey had been performed by rail

Different situations	Amount of exemption if journey is performed on or after October 1, 1997
When journey is performed by air	Amount of air economy class fare of the National Carrier by the shortest route or the amount spent, whichever is less
When journey is performed by rail	Amount of air-conditioned first class rail fare by the shortest route or the amount spent, whichever is less
When the places of origin of journey and destination are connected by rail and journey is performed by any other mode of transport	Amount of air-conditioned first class rail fare by the shortest route or the amount spent, whichever is less
<b>Where the places of origin of journey and destination (or part thereof) are not connected by rail :</b>	
a. Where a recognised public transport system exists	First class or deluxe class fare by the shortest route or the amount spent, whichever is less
b. Where no recognised public transport system exists	Air-conditioned first class rail fare by the shortest route (as if the journey has been performed by rail) or the amount actually spent, whichever is less

Salary  
5.9



**1. Meaning of "family"** : The aforesaid exemption is available in respect of fare for going anywhere in India along with "family". For this purpose, "family" includes spouse and children of the employee. It also includes parents, brothers and sisters of the employee, who are wholly or mainly dependent upon employee. However, family does not include more than two surviving children of individual born on or after Oct 1, 1998 (in reckoning this limit of two children, children born out of multiple births after the first child will be treated as 'one child only')

**2. Only 2 journey in a block of 4 years is exempt** : Exemption on the aforesaid basis is available in respect of 2 journey performed in a block of 4 calendar years commencing from 1986

**3. "Carry-over" concession** : If an assessee has not availed travel concession or assistance during any of the specified four-year block periods on one of the two permitted occasions (or on both occasions), exemption can be claimed in the first calendar year of the next block (but in respect of only one journey). This is known as "carry-over concession". In such case, the exemption so availed will not be counted for the purposes of claiming the future exemptions allowable in respect of 2 journeys in the subsequent block

**4. Exemption is based upon actual expenditure** : The quantum of exemption is limited to the actual expenses incurred on the journey. In other words, without performing any journey and incurring expenses thereon, no exemption can be claimed

**5. Exemption is available in respect of fare** : The exemption is strictly limited to expense on air fare, rail fare, bus fare only. No other expenses like scooter or taxi charges at both ends, portage expenses during the journey and lodging/boarding expenses will qualify for exemption

# If the assessee exercises the option of shifting out of the default tax regime provided u/s 115BAC(1A) [FA 2023]

Salary  
5.10

CA CS VIJAY SARDA  +91 895665 1954

www.ekatvamacademy.com/www.vlearnclasses.com

## Provident Fund

The tax treatment is given below during the Employment period :

Particulars	Recognised PF	Unrecognised PF	Statutory PF	Public PF
<b>Employer's Contribution</b>	Contribution in excess of 12% of salary is taxable as "salary" u/s 17(1)	Not taxable at the time of contribution	Fully exempt	N.A.(as there is only assessee's own contribution)
<b>Employee's Contribution</b>	Eligible for deduction u/s 80C, where an employee exercises the option of shifting out of the default tax regime provided u/s 115BAC(1A)	Not eligible for deduction	Eligible for deduction u/s 80C, where an employee exercises the option of shifting out of the default tax regime provided u/s 115BAC(1A)	Eligible for deduction u/s 80C, where an employee exercises the option of shifting out of the default tax regime provided u/s 115BAC(1A)
<b>Interest Credited on Employer's Contribution</b>	Amount in excess of 9.5% p.a. is taxable as "salary" u/s 17(1)	Not taxable at the time of credit of interest	Fully exempt	N.A.
<b>Interest Credited on Employee's Contribution</b>	Amount in excess of 9.5% p.a. is taxable as "salary" u/s 17(1) [See Note below]	Not taxable at the time of credit of interest	Exempt upto certain limit of contribution [See Note below]	Fully exempt
<b>Amount withdrawn on retirement/termination</b>	Exempt u/s 10(12) subject to certain conditions detailed in the chart below	<ul style="list-style-type: none"> <li>Employee's contribution is not taxable.</li> <li>Interest on Employee's contribution is taxable under 'Income from Other Sources'.</li> <li>Employer's contribution and interest thereon is salary</li> </ul>	Exempt u/s 10(11)	Fully exempt u/s 10(11)

- > Interest-free/concessional loan of an amount not exceeding ₹20,000.
- > Comp/laptop given (not transferred) to EE for official/personal use.
- > Transfer without consideration to an employee of a movable asset (other than computer, electronic items or car) by employer after using it for a period of 10 years or more.
- > Traveling facility to employees of railways or airlines.
- > Rent-free official residence & Conveyance to a HC/SC Judge.
- > Conveyance facility provided to an EE between office & residence.
- > Accommodation provided on transfer of an employee in a hotel for not exceeding 15 days in aggregate.
- > Interest free loan for medical treatment of nature given in Rule 3A.
- > Periodicals and journals required for discharge of work.

### Any annual accretion of interest dividend In Fund

Any annual accretion by way of interest, dividend or any other amount of similar nature during the previous year to the balance at the credit of the recognized provident fund or NPS or approved superannuation fund to the extent it relates to the employer's contribution which is included in total income in any previous year under section 17(2)(vii) computed in prescribed manner [Section 17(2)(viiia)].

In other words, interest, dividend or any other amount of similar nature on the amount which is included in total income under section 17(2)(vii) would also be treated as a perquisite.

The CBDT has, vide Rule 3B, notified the following manner to compute the annual accretion by way of interest, dividend or any other amount of similar nature during the previous year-

$$TP = (PC/2)*R + (PC1 + TP1)*R$$

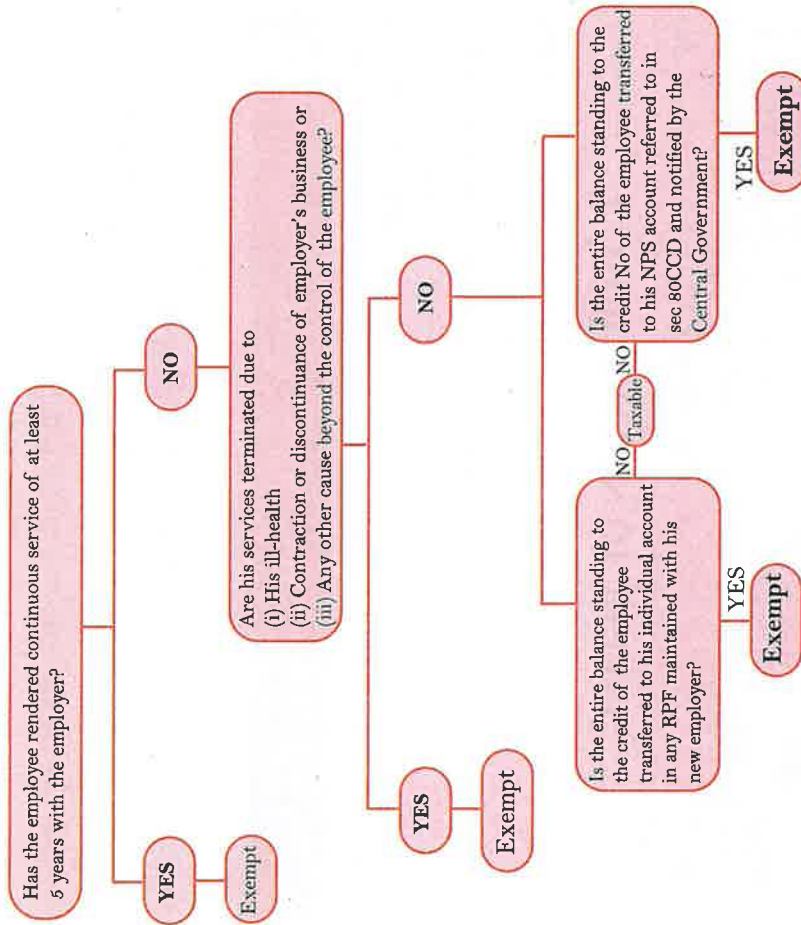

### Fully Exempted Perks

The following are not included for TDS u/s 192 -

- > **Tea or snacks** provided during working hours.
- > **Free meals** provided during working hours in a remote area or an offshore installation.
- > Perquisites allowed outside India by Govt to citizen of India for rendering service outside India.
- > Employer's contribution to staff group insurance scheme.
- > Free educational facility provided in an institute owned/maintained by employer to children of ee provided cost/value doesn't exceed ₹1,000 pm per child (no limit on no. of children).

Salary  
5.11

CA CS VIJAY SARDA +91 8956651954

www.ekatvamacademy.com/www.vlearnclasses.com



Where,

<b>TP</b>	Taxable perquisite under section 17(2) (vii-a) for the current previous year
<b>PC</b>	Amount or aggregate of amounts of employer's contribution in excess of ₹ 7.5 lakh to recognized provident fund, national pension scheme u/s 80CCD and approved superannuation fund during the previous year
<b>PC1</b>	Amount or aggregate of amounts of employers contribution in excess of ₹7.5 lakh is recognized provident fund, national pension scheme u/s 80CCD and approved superannuation fund for the previous year or years commencing on or after 1st April, 2020 other than the current previous year
<b>TP1</b>	Aggregate of taxable perquisite under section 17(2) (vii-a) for the previous year or years commencing on or after 1st April, 2020 other than the current.
<b>R</b>	I/ Favg
<b>I</b>	Amount or aggregate of amounts of income accrued during the current previous year in recognized provident fund, national pension scheme u/s 80CCD and approved superannuation fund.
<b>Favg</b>	(Amount or aggregate of amounts of balance to the credit of recognised provident fund, national pension scheme u/s 80CCD and approved superannuation fund on 1st April, 2021 + Amount or aggregate of amounts of balance to the credit of recognized provident fund, national pension scheme u/s 80CCD and approved superannuation fund on 31st March.

Where the amount of aggregate of amount of TP1 and PC1 exceeds the amount or aggregate of amounts of balance to the credit of the specified fund or scheme on 1<sup>st</sup> April, 2021, then the amount in excess of the amount or aggregate of amounts of the said balance shall be ignored for the purpose of computing the amount or aggregate of amounts of TP1 and PC1.

### Limit On Interest Credited On Contribution By Such Employee

As per section 10(11), any payment from a Provident fund (PF) to which Provident Fund Act, 1925, applies or from Public Provident Fund would be exempt. Accumulated balance due and becoming payable to an employee participating in a Recognized Provident Fund (RPF) would be exempt u/s 10(12). However, the exemption u/s 10(11) or 10(12) would not be available in respect of income by way of interest accrued during the previous year to the extent it relates to the amount or the aggregate of amounts of contribution made by that persons/employee exceeding ₹ 2,50,000 in any previous year in that fund, on or after 1st April, 2021.

CA CS VIJAY SARDA  +91 89566651954

Salary  
5.12

www.ekatvamacademy.com/www.vlearnclasses.com

If the contribution by such person/ employee is in a fund in which there is no employer's contribution, then a higher limit of ₹ 5,00,000 would be applicable for such contribution, and interest accrued in any previous year in that fund, on or after 1st April, 2021 would be exempt upto that limit. It may be noted that interest accrued on contribution to such funds upto 31st March 2021 would be exempt without any limit, even if the accrual of income is after that date.

### Relief u/s 89(1) read with Rule 21A

Where an assessee receives the following amounts in a financial year:

- > Arrears of salary; or
- > Advance salary; or
- > Salary of more than twelve months; or
- > Profit in lieu of salary; or
- > Arrears of family pension

### COMPUTATION OF RELIEF

Step	Particulars	₹
1	Total income for this year (including arrears of salaries)	XXX
2	Tax on Step 1 including cess	XXX
3	Total income for this year excluding arrears of salaries	XXX
4	Tax on Step 3 including cess	XXX
5	Difference between Step 2 & Step 4 (A)	XXX
6	Total income for that year (including arrears of salaries)	XXX
7	Tax on Step 6 @ of that year	XXX
8	Total income for that year (excluding arrears of salaries)	XXX
9	Tax on Step 8 @ of that year	XXX
10	Difference between Step 7 & Step 9 (B)	XXX
11	Relief u/s 89(1) = (A) - (B)	XXX



- 1) Individuals and HUFs can opt for section 115BAC
- 2) The deduction u/c VI-A not available other than sec 80CCD(2)/80JAA;
- 3) The below chart contains the exemptions and deduction not available under the head Salary.

Nature of Exemption/Deduction Relating to Head Salaries	New System	Existing System
<b>RETIREMENT BENEFITS EXEMPTIONS</b>		
Leave Salary u/s 10(10aa)	✓	✓
Gratuity u/s 10(10)	✓	✓
Commutation of Pension u/s 10(10a)	✓	✓
Retrenchment Compensation u/s 10(10B)	✓	✓
VRS Compensation u/s 10(10C)	✓	✓
Leave travel Concession u/s 10(5)	X	✓
<b>ALLOWANCES</b>		
Exemption u/s 10(13A) & rule 2A from HRA	X	✓
Exemption u/s 10(14)(i) and Rule 2BB	✓	✓
Travelling allowance	✓	✓
Conveyance allowance	✓	✓
Daily allowance	X	✓
Helper allowance	X	✓
Any allowance granted for encouraging the academic, research & training pursuits in edu. & Research inst.	X	✓
Uniform allowance	X	✓
Exemption u/s 10(14)(ii) & Rule 2BB	X	✓
Children education allowance	X	✓
Hostel expenditure allowance	X	✓
Tribal area allowance	✓	✓
Transport allowance to Handicapped/deaf/dumb/Blind employee	✓	X
Transport allowance to other than above employees	X	
<b>PERQUISITES</b>		
Free food and beverage through vouchers provided to the employee upto 50/meal/tea & snacks	X	✓
Other exemptions from perquisites e.g. use of Computers, laptops etc	✓	✓
Deductions u/s 16	X	✓
Standard deduction u/s 16(ia)	X	✓
Entertainment allowance u/s 16(ii)	X	✓
Professional tax u/s 16(iii)	X	✓

Salary  
5.13

## P.1 Based on Computation of Salary

Mr. Harish, aged 52 years, is Production Manager of XYZ Ltd. From following details, compute the taxable income for AY 2024-25.

Basic salary	50,000pm
Dearness allowance	40% of Basic
Transport allowance (for commuting between place of residence and office)	3,000 pm
Motor car running & maintenance charges fully paid by employer (The motor car is owned by co & driven by EE. The engine CC is above 1.60 litres. The motorcar is used for both official & personal purpose by the employee.)	60,000
Expense on accommodation in hotels while touring on official duties met by the employer	80,000
Loan from RPF (maintained by the employer)	60,000
Lunch provided by the employer during office hours.	24,000
Computer (cost Rs. 35,000) kept by employer in the residence of Mr. Harish from 1.06.2021	
Mr. Harish made the following payments: Medical insurance premium: Paid in Cash Paid by account payee crossed cheque.	15,200

## P.2 Based on Computation of Salary

Mr. Balaji employed as Production Manager in Beta LTD, furnishes you the following information for the year ended 31.03.2024:

- (a) Basic salary upto 31.10.2023 ₹50,000 p.m.  
Basic salary from 01.11.2023 ₹60,000 p.m.
- (b) Note: Salary is due and paid on the last day of every month.
- (c) Dearness allowance @ 40% of basic salary.
- (d) Bonus equal to one month salary. Paid in October 2023 on basic salary plus dearness allowance applicable for that month.  
Contribution of employer to RPF account employee@16% of basic salary.
- (e) Profession tax paid ₹3,000 of which ₹2,000 was paid by ER.
- (f) Facility of laptop & computer was provided to Balaji for both official & personal use. Cost of laptop ₹45,000 & computer ₹35,000 were acquired by the company on 01.12.2023.



- (g) Motor car owned by ER (CC of engine exceeds 1.60 litres) provided to EE from 01.11.2023 meant for both official & personal use. Repair & running expenses of ₹45,000 from 01.11.2023 to 31.03.2024, were fully met by ER. The motor car was driven by EE.
- (h) Leave travel concession given to EE, his wife & 3 children (1 daughter aged 7 & twin sons aged 3). Cost of air tickets (economy class) reimbursed by ER ₹30,000 for adults & ₹45,000 for 3 children. Balaji is eligible for availing exemption this year to the extent it is permissible in law. Compute salary income chargeable to tax for AY 24-25 assuming he exercises the option of shifting out of the default tax regime provided u/s 115BAC(1A).

### P.3 Based on Computation of Salary

From the following details, find out the salary chargeable to tax for the A.Y.2024-25 assuming he exercises the option of shifting out of the default tax regime provided under section 115BAC(1A) - Mr. X is a regular employee of Rama & Co., in Gurgaon. He was appointed on 1.1.2023 in the scale of ₹ 20,000 - ₹1,000 - ₹30,000. He is paid 10% D.A. & Bonus equivalent to one month pay based on salary of March every year. He contributes 15% of his pay and D.A. towards his recognized provident fund and the company contributes the same amount. DA forms part of pay for retirement benefits. He is provided free housing facility which has been taken on rent by the company at ₹ 10,000 per month. He is also provided with following facilities:

- Facility of laptop costing ₹ 50,000.
- Company reimbursed the medical treatment bill of his brother of ₹25,000, who is dependent on him.
- The monthly salary of ₹1,000 of a house keeper is reimbursed by the company.
- A gift voucher of ₹10,000 on the occasion of his marriage anniversary.
- Conveyance allowance of ₹1,000 per month is given by the company towards actual reimbursement of conveyance spent on official duty.
- He is provided personal accident policy for which premium of ₹5,000 is paid by the company.
- He is getting telephone allowance @₹500 per month.

### P.4 Based on Computation of Gross Salary

Mr. Mohit is employed with XY Ltd. on a basic salary of ₹10,000 p.m. He is also entitled to DA @ 100% of basic salary, 50% of which is included in salary as per terms of employment. Co gives him HRA of ₹6,000 p.m. & increased to ₹7,000 p.m. w.e.f 1.01.2024. He also got an increment of ₹1,000 p.m. in his basic salary w.e.f 1.02.2024. Rent paid by him during the PY 2023-24 is as under:

April and May, 2023 : Nil, as he stayed with his parents  
June to October, 2023 : ₹6,000 p.m. in Ghaziabad

November, 2023 to March, 2024 : ₹8,000 p.m. in Delhi.

Compute his gross salary for AY 24-25 assuming he exercises the option of shifting out of the default tax regime provided u/s 115BAC(1A).

### P.5 Based on Computation of Allowance

Compute the Salary of Mr. Darshan

Particulars	₹	Taxable
Basic	50,000pm	
DA	20,000pm	
Commission 3% of Turnover(T/o Rs.6L)		
Non Practising Allowance	800pm	
City Compensatory Allowance	700pm	
Warden Allowance	600pm	
Project Allowance	15,000 pa	
Advance Salary	2 months	
Tiffin Allowance	600 pm	
Overtime Allowance	900pm	
Entertainment Allowance	1,200pm	
Leave Encashment	800pm	
Total Salary		

# Chapter 6

## INCOME FROM OTHER SOURCES

### IMPORTANT AMENDMENTS/ NOTIFICATIONS/CIRCULARS

Sr No	Particulars	Pg No
1	Sec 56	6.2
2	Advance Money Forfeited	6.2
3	Interest On Compensation & Enhance Compensation	6.2
4	Sec 56(2)(x) Taxation of Gifts	6.2
5	Gift Received From Following Is Exempt:	6.2
6	Property Meaning	6.3
7	Relative Meaning	6.4
8	Notification 96/2019	6.4
9	Family Pension	6.4
10	Residual Income	6.4
11	Casual Income	6.4
12	Share Issued At Premium	6.5
13	Sec 8 Dividend Income	6.5
14	Taxability of Dividend In The Hands of Shareholder	6.5
15	Deemed Dividend	6.6
16	Liability of Company	6.6
17	Sec 194 Taxation of Dividend In Case of Resident	6.6
18	Sec 195 Taxation In Case of NR	6.6
19	Sec 115BBD Dividend received by Indian Company From Foreign Company	6.6
20	Interest on Securities	6.7
21	Taxability of LIP	6.7
22	Deduction Allowed u/s 57	6.8
23	Deduction Not Allowed u/s 58	6.9
24	Unsolved Questions	6.9

Sr No.	Particulars	Pg No
1	Gift received from following is exempt	6.2
2	Property Meaning	6.3
4	Sec 115BBD Dividend received by Indian Co.	6.4
5	Deduction allowed u/s 57	6.6



“  
The best  
fighter  
is never  
angry  
”



## Sec 56

### Sec 56(1):

Income of every kind which is not exempt & chargeable to tax under any any of the other head, shall be chargeable under Income from Other Sources.

### Sec 56[2]:

1. Casual income.
2. Interest on compensation & enhance compensation.
3. Income from subletting of HP.
4. Rent from a vacant plot.
5. Composite Rent Non-separable.
6. Advance money forfeited.
7. Director sitting fees.
8. Agriculture Income from foreign.
9. Dividend
10. Gift
11. Family Pension
12. Income of MP, MLA.
13. Interest on income tax refund Income tax refund is not an Income

### Following Income shall be Taxable if not Taxable in PGBP

14. Interest on Loan/securities.
15. Income from Letting of P&M & Furniture
16. Sum received under keyman Insurance policy including sum by way of Bonus.
17. Royalty
18. Any compensation or other payment received by any person in connection with the termination of his employment or the modification of the terms and conditions relating thereto.
19. Income from Undisclosed Sources.
20. Issue of share @ premium.

## Advance Money Forfeited

Forfeited on or after 01.04.2014 is taxable under IFOS

## Interest On Compensation & Enhance Compensation

Such interest is taxable in IFOS in the year of receipt & 50% of such interest is allowed as deduction (Sec 57), irrespective of the year to which it pertains.

## Sec 56(2)(x) Taxation of Gifts

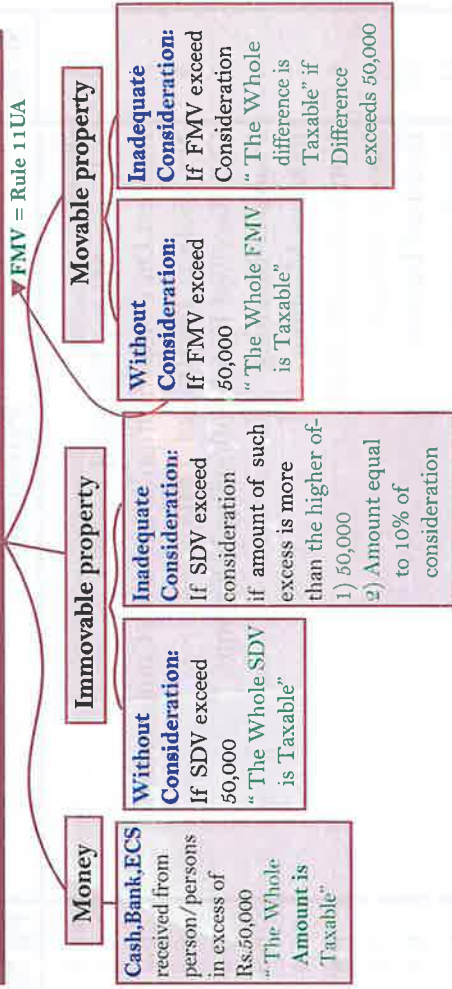

### Notes:

1. Where the date of agreement & the date of registration are not the same, the stamp duty value on the date of agreement may be taken if following conditions are Satisfied :
  - a. Consideration or part thereof is paid as on the date of agreement &
  - b. Such Consideration is paid by way of Account payee cheque, draft, ECS, Other electronic Mode(Rule 6ABBA).
2. Where the stamp duty value is disputed then provision of Section 50C is applicable with respect to Full value of consideration.

## Gift Received From Following Is Exempt

- 1) From any relative (Whether having any occasion or not )
- 2) On the occasion of the marriage of the individual (from relative or not)
- 3) Under a will or by way of inheritance
- 4) In contemplation of death of the payer or donor
- 5) From any local authority

- 6) From any fund or foundation or university or other educational institution or hospital or other medical institution or any trust or institution referred to in sec 10(23C)
- 7) From or by any trust or institution registered u/s 12A / 12AA / 12AB
- 8) By any fund or trust or institution or any university or other educational institution or any hospital or other medical institution referred in sec 10 (23C)(iv)/(v)/(vi)/(via); or If sum or property is received by any person referred u/s 13(3) from any Fund registered u/s 10(23C) or trust registered u/s 12AA/12AB then such sum shall be Taxable
- 9) By way of transaction not regarded as transfer u/s 47(i)/(iv)/(v)/(vi)/(via)/(vii)/(viii)/(vica)/(vicb)/(vid)/(vii),(viiac) or (viiad) or (viiae) or (viiaf).
- 10) From an individual by a trust created or established solely for the benefit of relative of the individual;
- 11) From such class of persons & subject to such conditions, as may be prescribed.
- 12) Received by an Individual, from any person, for medical treatment or treatment of any member of his family, for any illness related to COVID-19 subject to such conditions, as CG may Notify.

Accordingly, the Central Government has, vide Notification No. 91/2022 dated 5.8.2022, specified that for such purpose, the individual has to keep a record of the following documents, namely:-

- (a) The COVID-19 positive report of the individual or his family member, or medical report if clinically determined to be COVID-19 positive through investigations in a hospital or an in-patient facility by a treating physician for a person so admitted;
  - (b) All necessary documents of medical diagnosis or treatment of the individual or family member due to COVID-19 or illness related to COVID-19 suffered within 6 months from the date of being determined as a COVID-19 positive; The details of the amount so received in any financial year has to be furnished in the prescribed form to the Income-tax Department within 9 months from the end of such F.Y. [FA 2023]
- 13) Received By a member of the family of a deceased person -**
- i) From the employer of the deceased person; or
  - ii) From any other person or persons to the extent that such sum or aggregate of such sums does not exceed 10 lakh rupees,

- Where the cause of death of such person is illness related to COVID-19 and the payment is -
- i) Received within 12 months from the date of death of such person; and
  - ii) Subject to such other conditions, CG may notify.

**Accordingly, the Central Government has, vide Notification No. 92/2022 dated 5.8.2022, specified the following conditions -**

1. (i) The death of the individual should be within 6 months from the date of testing positive or from the date of being clinically determined as a COVID-19 case, for which any sum of money has been received by the member of the family;
  - (ii) The family member of the individual has to keep a record of the following documents -
    - (a) The COVID-19 positive report of the individual, or medical report if clinically determined to be COVID-19 positive through investigations in a hospital or an inpatient facility by a treating physician;
    - (b) A medical report or death certificate issued by a medical practitioner or a Government civil registration office, in which it is stated that death of the person is related to corona virus disease (COVID-19).
  2. The details of such amount received in any FY has to be furnished in the prescribed form to the AO within 9 months from the end of such FY. [FA 2023]
- > "Family"**(For clause 12 & 13), in relation to an individual means
- (i) The spouse and children of the individual ; and
  - (ii) The parents, brothers and sisters of the individual or any of them, wholly or mainly dependent on the individual.

## Property Meaning

- i) Immovable property being land or building or both;
- ii) Shares and securities
  - iii) Jewellery & Bullion
  - v) Drawing
  - vii) Any work of art
  - ix) Virtual Digital Assets
- iv) Archaeological collections
- vi) Paintings
- viii) Sculptures





## Relative Meaning

- > Spouse of the Individual
- > Brother/Sister of the Individual/Spouse of the Individual
- > Brother/Sister of either of the Parents of the Individual
- > Any lineal ascendant/descendant of the Individual
- > Any lineal ascendant/descendant of the Spouse of the Individual
- > Spouse of the person referred to in clause (ii) to (vi)
- > In case of HUF - any member

## Notification 96/2019

Sec 56(2)(x) is not applicable if immovable property is received by a resident of unauthorised colony in national capital territory of Delhi, when CG by notification regularize such transaction which are based on latest power of attorney, agreement to sell, will/possession letter & other document evidencing payment for the right of ownership or transfer or mortgage in regards to such property.

Stamp Duty Value as on the date of agreement can be considered if full/part consideration is received by account payee cheque/draft/ECS/other mode as may be prescribed (Refer CG)

## Family Pension

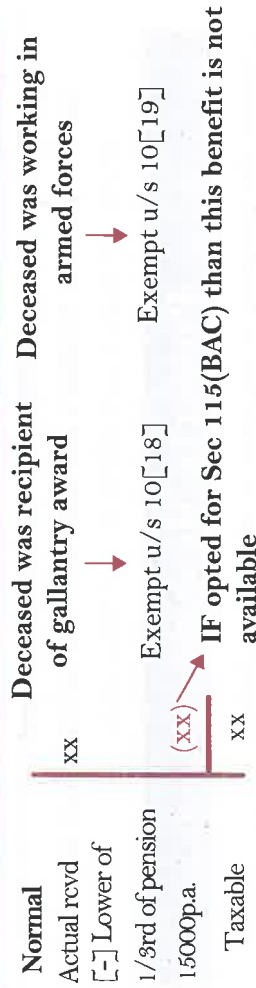

Pension received to family member of Deceased.

# If assessee opts for Sec 115BAC, Deduction in respect of family pension is not available.

## Residual Income

Any income chargeable to tax under the Act, but not falling under any other head of income shall be chargeable to tax under the head "IFOS". For example, salary received by an MPs/MLAs will not be chargeable to income-tax under the head 'Salary' but will be chargeable as "IFOS" u/s 56. However, the following incomes of Members of Parliament or State Legislatures will be exempt under section 10(17):

- i) **Daily Allowance** - Daily allowance received by any Member of Parliament or of any State Legislatures or any Committee thereof
- ii) **Constituency Allowance of MPs** - In the case of a Member of Parliament, any allowance received under Members of Parliament (Constituency Allowance) Rules, 1986; and
- iii) **Constituency allowance of MLAs** - Any constituency allowance received by any person by reason of his membership of any State Legislature under any Act or rules made by that State Legislature. [FA 2023]

## Casual Income

**Income by way of**  
 Lottery  
 Horse races  
 Betting  
 Card Game  
 Crossword puzzle  
 Games of any sort

### Notes:

1. Sec 58(4), no deduction is allowed from such Income
2. U/s 115BB it is taxable @ 30%
3. Deduction u/s 80C-80U is not available
4. Generally casual Income is Received after TDS [Net of TDS] Hence we need to Gross up.  
 > If Problem gives Net amount gross it  
**Grossing up = Amount received / 100 - TDS Rate**
5. Lottery held as stock in trade taxable in PGBP.  
 > If nothing is given assume it is Gross up

Tax on Income from Other Sources			
<b>Income</b> Winning from lotteries, crossword puzzles, races including horse races, card games and other games, gambling, betting etc. (other than winning from any online game)	Unexplained cash credits/ investments/ money, bullion, jewellery etc./ expenditure, etc.	Net winnings from online games	Net winnings from online games
<b>Section</b> Section 115BB	<b>Section 115BBE</b> 60% of such income plus surcharge @25% of tax (Effective rate of tax is 78%, including HEC @4%)	<b>Section 115BBJ</b> 30% of such winnings (further increased by surcharge, if applicable, and HEC @4%)	Normal rates of tax
<b>Other conditions</b> > No expenditure or allowance can be allowed from such income. > Deduction under Chapter VI-A is not allowable from such income. > Adjustment of unexhausted basic exemption limit is also not Permitted against such income. > Set-off of losses is not permissible against such income.			Deductions specified in sec 57 allowable, subject to limits mentioned thereunder. Sec 58 specifies the deductions not allowable.

## Share Issued At Premium

If a closely held company [Private Co.] issued to share to a resident shareholder on premium then consideration (-) FMV = IFOS

### Exception :

- 1) Premium received by Venture Capital Undertaking &
- 2) Person specified by Central Govt (as of now Cat I AIF is specified)
- 3) Issue of Share at Premium by Category II AIF shall be exempt
- 4) Startup if prescribe conditions are satisfied.

### FMV shall be higher of :

- 1) As determined according to prescribe method
- 2) As specified by company to the satisfaction of AO based on its value of assets on the date of issue of shares

For Computation of FMV the value of assets include value of intangible assets

## Sec 8 Dividend Income

- 1) Interim Dividend shall deemed to be income of PY in which such dividend is made available by company to member
- 2) Dividend includes deemed dividend u/s 2(22)(a) to (e).

## Taxability of Dividend In The Hands of Shareholder

- 1) From 01.04.20, dividend income is taxable in the hands of shareholder
- 2) The PY in which dividend is taxable :

Type of Dividend	PY in which it is taxable
Interim Dividend	Taxable in the year in which it is received
Final Dividend	Taxable in the year in which it is declared at AGM
Deemed Dividend	Taxable in the year in which it is distributed or paid
Sec 2(22)(a) - (e)	

### 3) Surcharge on Dividend

For Individual & HUF - The surcharge on dividends & capital gains u/s 111A / 112A shall not exceed 15%

- a) Upto 50lakhs No surcharge
- b) Exceeds 50L upto 1cr. 10%
- c) Exceeds 1cr upto 2cr 15%
- d) Beyond 2cr. 15% only

### 4) Allowability of Expenses from Dividend Income

- 1) Sec 57 provides that while computing the dividend income, interest expense is allowed lower of
  - a) Actual interest
  - b) 20% of dividend income before such deduction

- 2) No expenses except above shall be allowed as deduction

### 5) When Dividend is received by NR & Foreign Company

- a) Dividend income is taxable (as per Sec 115A the tax rates will be 20%)
- b) The Payer Company shall deduct the TDS u/s 195 @ 20%

### 6) When Dividend is received by Company

Company also invest in the shares of another company & it also receives dividend which is taxable to the Company at the same time also pays the dividend & therefore, FA'20 has inserted a new section 80M for deduction in respect of inter-corporate dividends



## Deemed Dividend

Sec	Particulars	Relevant point
2(22)(a)	Any distribution by a company, to the extent of accumulated profits (capitalised or not), resulting release of its assets to its shareholders # Issue of bonus shares is not deemed dividend. # When assets are distributed, FMV of asset as on date of distribution has to be taken.	Amount of dividend = FMV of assets as on the date of distribution has to be taken for calculation of dividend
2(22)(b)	Any distribution to its shareholders by a Co > Of debentures/debenture-stock/deposit certificates, > Of bonus to its preference shareholders, > To the extent of accumulated profits (capitalised or not).	If bonus shares are issued to equity shareholders, it does not amount to distribution of dividend.
2(22)(c)	Any distribution to the shareholders of a Co on its liquidation, to the extent of its accumulated profits (capitalised or not).	In such case, there will be no CG in the hands of the CO u/s 46(1), however, the shareholder will be subject to CG
2(22)(d)	Any distribution to its shareholders by a Co. on the reduction of its capital, to the extent of accumulated profits (capitalised or not).	
2(22)(e)	<b>Loans &amp; Advances by Closely Held Company:</b> 1. Loan & Advances by Private Co [closely held co] is treated as Deemed Dividend to the extent of accumulated profit 2. Accumulated profit means profit as per companies Act 3. Substantial Interest in case of companies shall be 10% of voting rate in case of other concern it shall be 20% of profit or voting right 4. <b>Tarulata Shyam v. CIT (SC)</b> : Section is applicable at the time when loan is given hence even if loan is repaid during the year then also sec applies. 5. It is not applicable in case of trade advances. [Cir 19/2017] 6. Accumulated profits means all profit which is available for distribution or payment of dividend & u/s 2[22][c] all profits up to date of liquidation. 7. In case of an amalgamated company. Accumulated profits, whether capitalized /not/loss as the case may be shall be increased by accumulated profits whether capitalized/not of amalgamating company on date of amalgamation. <b>Dividend Does not Include:</b> a) Loan, Advances given in the ordinary course of Business. b) buy back of shares c) Any Dividend which is set-off by company against loan which has been deemed as dividend u/s 2[22][e] d) Share allotted to shareholder of demerged company by resulting Co. [under the scheme of demerger] e) Any distribution made u/s 2[22][c]/2[22][d] in respect of preference share	

IFOS  
6.6

CA CS VIJAY SARDA  +91 8956651954

## Liability of Company

The Payer Company now not liable to deduct Tax u/s 115-O The Payer Company is liable to deduct TDS u/s 194 in case of Resident whereas Sec 195 in case of Non Resident

## Sec 194 Taxation of Dividend In Case of Resident

<b>Payer [Deductor]</b>	Principal officer of any Indian Co / a company which has made prescribed arrangements for the declaration and payment of dividends (including dividends on preference shares) within India
<b>Payee [Deductee]</b>	Shareholder being Resident
<b>Limit</b>	If dividend does not exceed ₹5,000
<b>Rate</b>	10%
<b>Time of Deduction</b>	Before making any payment by any mode in respect of any dividend or before making any distribution or payment
<b>Special points</b>	This section shall not apply to such income credited or paid to- a) The LIC of India b) The GIC of India c) Any other insurer in respect of any shares owned by it or in which it has full beneficial interest.

## Sec 195 Taxation In Case of NR

TDS shall be deducted @ 20% + 4% HEC.

## Sec 115BBD Dividend received by Indian Company From Foreign Company

Dividend received by Indian Company from Foreign Company where Indian Company holds 26% or more equity share capital of a Foreign Company & such foreign company pays dividend, then such dividend is taxable in the hands of Indian Company (+ Surcharge if total income is > 1cr. of Indian Company + HEC @ 4%)

www.ekatvamacademy.com/ www.vlearnclasses.com



**Note :** No other expense shall be allowed against dividend, means Gross Dividend is taxable in the hands of Indian Company @ 15%

**The provisions of this section shall not apply to any assessment year beginning on or after the 1st day of April 2023.**

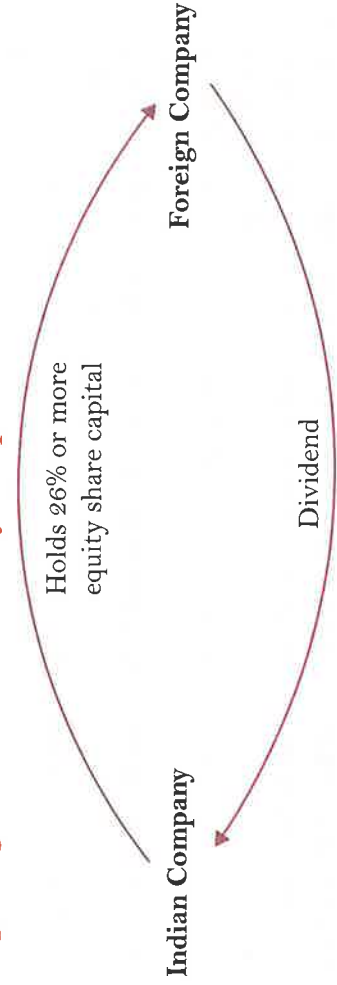

## Interest on Securities

- > It is Taxable in IFOS if not taxable in PGBP
- > Interest earned on Debenture, Deposit, Bond, securities of CG, Loan, advances shall be taxable

### Following Interest income is exempt u/s 10(15) :

1. Interest etc. on notified Government Securities or bonds
2. Interest received by any individual/ HUF on notified capital investment bonds,
3. Interest received by any individual or HUF on notified relief bonds,
4. Interest on notified Gold Deposit bonds,
5. Interest on notified bonds of local authorities,
6. Interest on securities held by Welfare Commissioner, Bhopal Gas Victims,
7. Interest payable by IFCI or IDBI,
8. Interest payable by any scheduled bank to a non-resident on approved deposit of foreign currency.

**Note:** Interest from investment in Non-SLR Securities of Banks CBDT clarified that the investments made by a banking concern are part of the business of banking. Therefore, the income arising from such investments is attributable to the business of banking and chargeable under PGBP and not under IFOS

## Taxability of LIP

Any sum received under a life insurance policy, including the sum allocated by way of bonus on such policy would not be included in the total income of a person [Sec 10(10D)]. [FA 2023] The following table summarizes the exemption available u/s 10(10D) vis-a-vis the date of issue of such policies and the corresponding condition to be satisfied for exemption -

<b>In respect of policies issued before 1.4.2003</b>	Any sum received under a LIP including the sum allocated by way of bonus is exempt
<b>In respect of policies issued between 1.4.2003 and 31.3.2012</b>	Any sum received under a LIP including the sum allocated by way of bonus is exempt. However, exemption would not be available if the premium payable for any of the years during the term of the policy exceeds 20% of "actual capital sum assured".
<b>In respect of policies issued on or after 1.4.2012 but before 1.4.2013</b>	Any sum received under a LIP including the sum allocated by way of bonus is exempt. However, exemption would not be available if the premium payable for any of the years during the term of the policy exceeds 10% of actual capital sum assured.
<b>In respect of policies issued on or after 1.4.2013</b>	<p>a) Where the insurance is on the life of a person with disability or severe disability as referred to in section 80U or a person suffering from disease or ailment as specified under section 80DDDB. Any sum received under a LIP including the sum allocated by way of bonus is exempt. However, exemption would not be available if the premium payable for any of the years during the term of the policy exceeds 15% of "actual capital sum assured"</p> <p>b) Where the insurance is on the life of any person, other than mentioned in a above. Any sum received under a LIP including the sum allocated by way of bonus is exempt. However, exemption would not be available if the premium payable for any of the years during the term of the policy exceeds 10% of "actual capital sum assured".</p>
<b>In respect of policies issued on or after 1.4.2023</b>	Any sum received under a LIP including the sum allocated by way of bonus is exempt. However, exemption would not be available if the premium payable for any of the years during the term of the policy exceeds 10% or 15%, as the case may be, of "actual capital sum assured. Further, exemption would also not be available if the amount of premium payable exceeds ₹ 5,00,000 for any of the previous years during the term of such policy. In a case where premium is payable by a person for more than one LIP (other than ULIP) and the aggregate of premium payable on such policies exceed ₹ 5,00,000 for any of the previous years during the term of any such policy(ies), exemption would be available in respect of any of those LIPs (other than ULIP), at the option of the assessee, whose aggregate premium payable does not exceed ₹ 5,00,000 for any of the previous years during their term.
	Any sum is received on the death of a person is exempt irrespective of the annual premium payable on the policy. The condition of payment of premium of 10% or 15% or 20% or ₹ 5,00,000 would not be applicable



**Exemption is not available in respect of amount received from an insurance policy taken for disabled person u/s 80DD:** Any sum received u/s 80DD(3) shall not be exempt u/s 10(10D). Accordingly, if the dependent disabled, in respect of whom an individual or the member of the HUF has paid or deposited any amount in any scheme of LIC or any other insurer, predeceases the individual or the member of the HUF, the amount so paid or deposited shall be deemed to be the income of the assessee of the previous year in which such amount is received. Such amount would not be exempt u/s 10(10D).

**Exemption is not available in respect of the sum received under a**

**Keyman insurance policy:** Any sum received under a Keyman insurance policy shall also not be exempt. Explanation 1 to section 10(10D) defines "Keyman insurance policy" as a life insurance policy taken by one person on the life of another person who is or was the employee of the first-mentioned person or is or was connected in any manner whatsoever with the business of the first-mentioned person. The term includes within its scope a keyman insurance policy which has been assigned to any person during its term, with or without consideration. Therefore, such policies shall continue to be treated as a keyman insurance policy even after the same is assigned to the keyman. Consequently, the sum received by the keyman on such policies, being "keyman insurance policies", would not be exempt u/s 10(10D).

**Taxability of sum received under a LIP which is not exempt**

**u/s 10(10D) :** Where any sum is received (including the amount allocated by way of bonus) at any time during a previous year, under a life insurance policy, other than the sum -

- (i) Received under a ULIP
- (ii) Received under a Keyman insurance policy; which is not exempt u/s 10(10D), the sum so received as exceeds the aggregate of the premium paid during the term of such life insurance policy, and not claimed as deduction under any other provision of the Act, computed in the prescribed manner, would be chargeable to tax under the head "Income from other sources".

## Deduction Allowed u/s 57

1. Expenditure for realizing dividend or interest from UTI/MF only Interest exp allowed & that too 20% of such dividend/income from UTI / MF
2. Employees' contribution towards relevant fund(s) before the due date As per that Act [Sec 57(IA)]
3. Repair, depreciation, insurance of plant, machinery, furniture, building [Sec 57(ii)]
4. Standard deduction in case of family pension lower of 1/3rd of Pension Or Rs.15000p.a.
5. Other deductions incurred for business is allowed as deduction Sec 57(iii)
6. 50% of the amount of interest on compensation or enhanced compensation
7. In the case of dividends, or interest on securities, any reasonable sum paid by way of commission or Remuneration to a banker or any other person for the purpose of realizing such dividend or interest on behalf of the assessee;
8. Any expenditure in respect of which a payment is made to a related person: In addition to these disallowances, section 58(2) specifically provides that the disallowance of any expenditure in respect of which a payment is made to a related person, to the extent the same is considered excessive or unreasonable by the Assessing Officer, having regard to the FMV and disallowance of payment or aggregate of payments exceeding 10,000 or 35,000, as the case may be, made to a person during a day otherwise than by account payee cheque or draft or ECS through bank account or through such other prescribed electronic mode such as credit card, debit card, net banking, IMPS, UPI, RTGS, NEFT, and BHIM Aadhar Pay covered by section 40A will be applicable to the computation of income under the head 'Income from other sources' as well.
9. Disallowance of 30% of expenditure: 30% of expenditure shall not be allowed, in respect of a sum which is payable to a resident and on which tax is deductible at source, if -
  - Such tax has not been deducted or;
  - Such tax after deduction has not been paid on or before the due date of return specified in sec 139(1).

In case, assessee fails to deduct the whole or any part of tax on any such sum but is not deemed as assessee in default under the first proviso to section 201(1) by reason that such payee –

- (i) Has furnished his return of income under section 139;
  - (ii) Has taken into account such sum for computing income in such return of income; and
  - (iii) Has paid the tax due on the income declared by him in such return of income, and the payer furnishes a certificate to this effect from an accountant in such form as may be prescribed, it would be deemed that the assessee has deducted and paid the tax on such sum.
- The date of deduction and payment of taxes by the payer shall be deemed to be the date on which return of income has been furnished by the payee. [FA 2023]

## Deduction not Allowed u/s 58

1. Any personal expenses of the assessee.
2. Any interest or salary payable outside India on which tax has not been paid or deducted.
3. Any sum paid on account of Wealth-Tax
4. The provisions of section 40A shall apply mutatis-mutandis
5. Expenditure related to casual Income
6. 30% of the amount of payment made without TDS to Resident u/s 40(a)(ia).
7. Cash expense exceeding ₹10,000 - Sec 40A(3) shall apply.

## Unsolved Questions

### P1. Based on Gift + Enhanced Compensation

Mr. Rabbit acquired 5000 shares in ₹100 whose FMV is ₹180. Is the amount taxable? State whether the following are chargeable to tax & the amount liable to tax :

- > A sum of ₹1,20,000 was received as gift from non-relatives by on the occasion of the marriage of his son Pravin. Interest on enhanced compensation of ₹50,000 was received as per court decree in Dec'23 by Mr. Yogesh. Out of the said amount, a sum of ₹35,000, relates to preceding financial years.

> Interest on enhanced compensation of ₹96,000 received on 12-7-23 for acquisition of urban land, of which 40% relates to the earlier year.

### P2. Based on Concept of Gift

The following details have been furnished by Mrs. Romali pertaining to the year ended 31.03.2024. You are required to compute income, if any assessable as income from other sources.

- (a) Cash gift of 51,000 received from her friend on the occasion of her "Shastiapha Poorthi", a wedding function celebrated on her husband completing 60 years of age. This was also their 25th marriage anniversary.
- (b) On the above occasion, a diamond necklace worth 2lakhs was presented by her sister living in Dubai.
- (c) When she celebrated her daughter's wedding on 21.02.2023, her friend assigned in Mrs. Hemali's favour, a FD held by the said friend in a schedule bank; the value of the FD & the accrued interest on the said date was 51,000.

### P3. Based on Concept of Gift + Shares

Smt. Laxmi reports the following transactions :

- (a) Received cash gift on the occasion of her marriage on 18.07.2023 of 1,20,000. It includes gift of 20,000 received from non relatives.
- (b) On 01.08.2023, being her birthday, she received a gift by means of cheque, from her mother's Maternal uncle, the amount being 40,000
- (c) On 01.12.2023 she acquired a vacant site from her friend for 1,05,000. The stamp valuation authority fixed the value of site at 1,80,000 for stamp duty purpose
- (d) She bought 100 equity shares of a listed company from another friend for 60,000. The value of share in the stock exchange on the date of purchase was 1,15,000.

Determine amounts chargeable to tax for AY 24-25. Your answer should be supported by reasons.





## CAPITAL GAINS

Sr No	Particulars	Pg No	Sr No	Particulars	Pg No
1	Sec 45(1) Chargeability	7.2	25	4th Proviso To Sec 48	7.8
2	Sec 2(14) Capital Assets	7.2	26	5th Proviso To Sec 48 Foreign Exchange Fluctuation	7.8
3	Financial Assets	7.2	27	6th Proviso To Sec 48 Deemed Consideration	7.8
4	Types of Capital Assets	7.2	28	CG Exempt u/s 10	7.8
5	Sec 2(42A) Short term capital assets	7.3	29	Sec 112A Tax On Long Term Capital Gain	7.8
6	Sec 2(29AA) Long term capital assets	7.3	30	Notification 60/2018 Exception To STT Payment	7.9
7	Sec 2(47) Transfer of Capital Assets	7.3	31	Press Note DT. 20th Sept 2019	7.9
8	Determining period of Holding	7.3	32	Circular No. 743 Unlisted Deposit Under CGAS In the Hands Of Legal Heirs	7.9
9	Sec 48 Computation of Capital Gain	7.3			
10	Full Value of Consideration	7.4	33	Circular No 667	7.9
11	Sec 50C Full Value of Consideration of Land & Building	7.4	34	Exemptions u/s 54	7.10
12	Sec 50CA FVOC for transfer of share other than quoted		35	Sec 51 Forfeiture of Advance Received	7.11
13	Sec 50AA Computation of capital gains in case of Market Linked Debenture	7.4	36	Exception To Sec 45	7.11
14	Rule 11UAD Prescribe class of person on whom 50CA does not apply	7.4	37	Sec 45(1A) Insurance Compensation	7.11
15	Expenses of Transfer	7.5	38	Sec 45(2) Conversion of CA Into Stock in Trade	7.11
16	Sec 55(2) Cost of Acquisition	7.5	39	Sec 45(1B) ULIP Receipts	7.12
17	COA & COI of Intangibles	7.5	40	Sec 45(5) Compulsory Acquisition	7.12
18	Sec 49 Cost of Acquisition	7.5	41	Sec 45(5A) Registered Developer Agreement	7.12
19	Sec 55(1)(B) Cost of Improvement	7.6	42	Sec 50B Slump Sale	7.13
20	2nd Proviso to Sec 48 Indexed Cost of Acquisition & Improvement	7.6	43	Sec 46 Capital Gain On Liquidation	7.13
21	Index cost of Improvement	7.6	44	Sec 47 Transaction not regarded as Transfer	7.13
22	Benefit of Indexation Not Available To	7.7	45	Sec 111A Tax On Short Term Capital Gain	7.14
23	1st Proviso To Sec 48 Capital Gain in Case of NR	7.7	46	Sec 112 Tax On Long Term Capital Gain	7.14
24	3rd Proviso To Sec 48	7.7	47	Case Laws	7.14
			48	Unsolved Questions	7.15

## Sec 45(1) Chargeability



## Sec 2(14) Capital Assets

Capital asset means property of any kind connected to Business or not connected to Business, Movable or immovable, Tangible or Intangible and

Include	Exclude
<ul style="list-style-type: none"> <li>a) Any right in or in relation to an Indian company, including rights of management or control or any others right whatsoever. [Vodafone Case]</li> <li>b) Securities held by Foreign Institutional Investor (whether as Investment/ Stock in trade)</li> <li>c) Any ULIP issued on or after 1st Feb 2021 and premium for single policy exceed 25000 pa or Premium for multiple policy exceed 250000 pa. [Note: ULIP is issued on or after 1.2.2021 are not being made applicable at intermediate level.]</li> </ul>	<ul style="list-style-type: none"> <li>a) Stock in Trade (other than Security held by FII)</li> <li>b) Personal Effects</li> <li>c) Rural Agricultural Land in India</li> <li>d) Specified Bonds</li> </ul> <p>Land and Building are separate asset for the purpose of CG (C.R. Subramamiam)</p>

### Personal effects means Movable Property but Excludes (JADPAS) :

- 1) Jewellery
- 2) Archaeological Collections
- 3) Drawing
- 4) Paintings
- 5) Sculptures
- 6) Any work of art
- 7) Any immovable property

## Financial Assets

### Financial Assets Include :

- a) Equity/Preference Shares (Listed)
- b) Securities Debentures & Govt. Securities - Listed
- c) Units of UTI (Quoted or not quoted)
- d) Zero Coupon Bonds
- e) Unit of mutual fund Sec 10(23D) (Quoted or not quoted)

## Types of Capital Assets

Depends upon POHA	
<b>Long Term</b>	<b>Financial Assets</b> Held for More than 12 M
	<b>Special Assets</b> Held for More than 24 M
	<b>Others</b> Held for More than 36 M
<b>Short Term</b>	<b>Financial Assets</b> Held for Less than 12 M
	<b>Special Assets</b> Held for Less than 24 M
	<b>Others</b> Held for Less than 36 M

### Notes :

- 1) **Financial Assets Include :**
  - a) Equity/Preference Shares (Listed)
  - b) Securities Debentures & Govt Securities – Listed
  - c) Units of UTI (Quoted or not quoted)
  - d) Zero Coupon Bonds
  - e) Unit of mutual fund Sec 10(23D) (Quoted or not quoted)
- 2) **Special Assets Include :**
  - a) Immovable Property
  - b) Unlisted Shares

3)

Particulars	POHA
1) Equity oriented MF Units	1 year
2) Debt Oriented MF Units	3 years
3) Debenture Listed in Recognized Stock Exchange, India	1 year
4) Share listed outside India	2 years
5) Shares of Private Limited Companies	2 years
6) Debenture listed outside India	3 years
7) Unit of Business trust (Real Estate Investment trust - REIT) listed in Recognized Stock Exchange in India	3 years

CG  
7.2



## Sec 2(42A) Short term capital assets

Short-term capital asset means a capital asset held by an assessee for not more than 12/24/36m immediately Preceding date of transfer.

### Notes :

- As per Sec 50 any gain on transfer of depreciable asset shall be taxable as short term capital gain Irrespective of their period of holding.
- Capital gains arising from transfer of market linked debentures and units of a specified mutual fund would always be capital gains arising from transfer of short term capital assets irrespective of the period of holding of such assets. This is provided in section 50AA. [FA 2023]

## Sec 2(29AA) Long term capital assets

Purchased	Gift/Will/Inheritance/Amalgamation/Demerger	When Business Assets is converted into CA
From Date of Acquisition to Date of Transfer	Holding Period of Assessee + Holding Period of Previous Owner	POHA shall be counted from the date of Conversion

## Sec 2(47) Transfer of Capital Assets

- The sale, exchange/relinquishment of the asset.
- The extinguishment of any rights therein
- The compulsory acquisition
- Conversion of asset into stock-in-trade
- The maturity or redemption of a zero coupon bond
- Any transaction in part performance of a contract of immovable property u/s 53A of TOPA, 1882
- Any transaction of becoming a member of a society or company etc. having house building scheme for its members.

## Determining period of Holding

Situations of 49(1)	Holding Period of Assessee + previous Owner
Conversion of inventory into Capital Assets	From the date of Its conversion
Share Received in amalgamation	It shall be counted from the date of acquisition of shares in Amalgamating co
Share Received in Resulting co.	It shall be counted from the date of acquisition of shares Demerged co
Right Shares	Counted from the date of allotment Share
Bonus Shares	Counted from the date of allotment Share
Sweat equity share	Counted from the date of allotment or transfer of such equity Share
Conversion of Pref Shares into Equity	The period of holding shall be considered from the date of Acquisition of preference shares
Conversion of Debenture/Bond into shares	The period of holding shall be considered from the date of Acquisition of Bond/Debenture
Units of Business Trust [Pursuant to Sec 47(xvii)]	The period of holding shall include the period for which shares were held by Assessee
Units which become property of assessee in consideration of transfer u/s 47(xviii)]	The period of holding shall include the period for which the unit or units in consolidation of mutual fund were held by the Assessee
Assets acquired by Assessee	From the date of Acquisition
Depreciable Assets	Always ST irrespective of holding period
Conversion of SIT into CA	From the date SIT was acquired

## Sec 48 Computation of Capital Gain

Short term Capital Gains	Long term Capital Gains
Full Value of Consideration Less: Exp on Transfer Net Consideration Less: Cost of Acquisition Less: Cost of Improvement STCG	xxx (xxx) xxx (xxx) (xxx) xxx (xxx) xxx
Less: Exemption u/s 54B/D/G/GA	Full Value of Consideration Less: Exp on Transfer Net Consideration Indexed Cost of Acquisition Less: Indexed Cost of Improvement LTCG Less: Exempt U/s 54 to 54GB LTCG
STCG	xxx (xxx) xxx

CG  
7.3



#Provided that the COA or COI shall not include the deductions claimed in respect of interest u/s 24(b) or under the provision of chapter VI-A [FA 2023]

## Full Value of Consideration

Full value of consideration is amount of consideration received or receivable by transferor without making any deduction there from.

**If in Cash** - Take Actual Amount

**If in Kind** - As per Sec 50D take FMV wherever Consideration is not ascertainable or cannot be determined.

## Sec 50C Full Value of Consideration of Land & Building

If SDV exceed 110% of consideration then SDV shall be **FVOC** otherwise consideration so received shall be **FVOC**.

**SDV is on which Date:**

- SDV as on the date of registration is considered but;
- If the SDV as on Date of agreement can be taken:
  - If consideration or part thereof is received on the date of agreement
  - Consideration is receive by way of A/c payee cheque, ECS or any other electronic mode. (Rule 6ABBA)
- If SDV is in Dispute:** Reference will be made to VO (Valuation Officer)

Different Situation in reference to VO	Value by VO is higher than SVA Value by VO is lower than SVA but more than Assessee Value by VO is lower than value by Assessee	C= SVA C= VO Value C = Assessee Value
--	---	---

Not. 8/2020 - Other electronic mode includes Credit card, Debit card, net banking, IMPS, UPI, RTGS, NEFT & BHIM. Aforesaid notification is also applicable for sec 13A, 35AD, 40A, 43, 43CA, 44AD, 56, 80JIAA, 269SS, 269ST, 269T.

## Sec 50CA FVOC for transfer of share other than quoted

**Simplified Analysis -**

- > FMV shall be deemed to be the FVOC if consideration < FMV (Rule 11UAA)
- > Sec applies to all Assessee including NR.
- > Sec applies only if the shares are held as Capital Asset not stock in trade.
- > Sec applies to all kinds of shares - equity or preference. However, it does not apply to Debentures.

## Sec 50AA Computation of capital gains in case of Market Linked Debenture [FA 2023]

Where a unit of a Specified Mutual Fund acquired on or after 1/4/2023 or a Market Linked Debenture,

**Computation of Capital gains**

Particulars	Amount
FVC = Amount received / redemption Value	xxx
(-) Expenses on Transfer	(xxx)
Net Consideration	xxx
(-) COA of Debenture or Unit	(xxx)
STCG	xxx

**Notes:**

- No deduction shall be allowed for STT paid.
- "Market Linked Debenture" means a security which has an underlying debt security and where the returns are linked to market returns on other underlying securities or indices and include any security classified or regulated as a market linked debenture by SEBI.
- "Specified Mutual Fund" means a Mutual Fund where not more than 35% of its total proceeds is invested in the equity shares of domestic companies: Percentage of equity shareholding held in respect of the Specified Mutual Fund shall be computed with reference to the annual average of the daily closing figures.

CG  
7.4

CA CS VIJAY SARDA  +91 8956651954

www.ekatvamacademy.com/www.vlearnclasses.com



## Rule 11 UAD Prescribe class of person on whom 50CA does not apply

The provisions of section 50CA of the Act shall not apply to transfer of any movable property, being unquoted shares, of a company and its subsidiary and the subsidiary of such subsidiary by an assessee, where,

- (i) The Tribunal, on an application moved by the CG u/s 241 of the CA, 2013, has suspended the BOD of such company and has appointed new directors nominated by the CG under section 242 of the said Act; and
- (ii) Share of such company and its subsidiary and the subsidiary of such subsidiary has been transferred Pursuant to a resolution plan approved by the Tribunal u/s 242 of the CA, 2013 after affording a Reasonable opportunity of being heard to the jurisdictional Principal Commissioner or Commissioner.

## Expenses of Transfer

- a) Expenses on transfer is allowed as deduction (not exp on acquisition because it is added to cost)  
**Given in Cash :** Take Actual Amount  
**Given in % :** Take % of Sale Consideration not of FVOC
- b) Expenses on transfer include brokerage & other legal expenses for sale of Such assets
- c) Expenses on transfer does not include STT; Hence STT is not allowed as Deduction [7th Proviso to Sec-48]

## Sec 55(2) Cost of Acquisition

Cost of acquisition is value which assessee has paid, or amount which he has incurred, for acquisition of asset. It includes amount for completing / acquiring title (Interest on Borrowed capital)

## COA & COI of Intangibles

- 1) Goodwill of business/ profession
- 2) Right to manufacture, produce article or thing,
- 3) Right to carry on any business
- 4) Trademark/brand name of business,
- 5) Tenancy rights,
- 6) Route permits,
- 7) Loom hours.

**Self-Generated = Nil**  
**Purchased = Purchase price**

- 1) Benefit of FMV as on 01/04/2001 NOT available in case of these assets
- 2) No CG on Goodwill of Profession as per **B.C Shrinivasa Shetty (SC)**

## Sec 49 Cost of Acquisition

Sec 49(1)	i) Distribution of assets on total / partial partition of HUF ii) Gift or will or inheritance iii) Succession, inheritance or devolution of co. iv) Distribution of assets on liquidation of co. v) Transfer to revocable/irrevocable trust	Cost to the Previous Owner
Sec 49	Assets Acquired before 01.04.2001	Cost of acquisition/FMV as on 01.04.2001 whichever is higher
Shares	<b>Original Shares</b>	Amount paid for acquiring these shares
	<b>Right shares subscribed by the assessee</b>	Amount paid by him for acquiring such asset
	<b>Right shares subscribed by the other person</b>	Purchase price paid to person renouncing such right + amount paid to co. allotting such shares.
	<b>Right renouncement: if rights are renounced in favor of other person</b>	Nil
	<b>Bonus shares allotted before 1.4.2001</b>	FMV on 1.4.2001
	<b>Bonus shares allotted on or after 1.4.2001</b>	Nil
<b>Sweat Equity shares</b>		FMV for calculation of Perquisite
<b>If 112A applies</b>	COA = Higher of COA or lower of Sales consideration or FMV as on 31.03.2018	
<b>Immovable property</b>	If SDV as on 01.04.2001 is available then FMV as on 01.04.2001 should not be more than SDV as on 01.04.2001.	
<b>Property Received u/s 56(x)</b>	Cost of acquisition of the sum of money or property received without consideration or lower consideration u/s. 56(x) shall be value adopted u/s. 56(x)	
<b>Assets trf under IDS</b>	FMV of the assets taken into account for the purpose of Tax, surcharge and penalty. [As on 01.06.2016 shall be taken] In case of CA declared under IDS '16 : 1) Immovable Property - POH = Date of Acq. as per deed 2) Other Assets - POH = From 01.06.2016	
<b>Conversion of business assets into CA</b>	COA = FMV as on the date of conversion	

## Sec 55(I)(B) Cost of Improvement

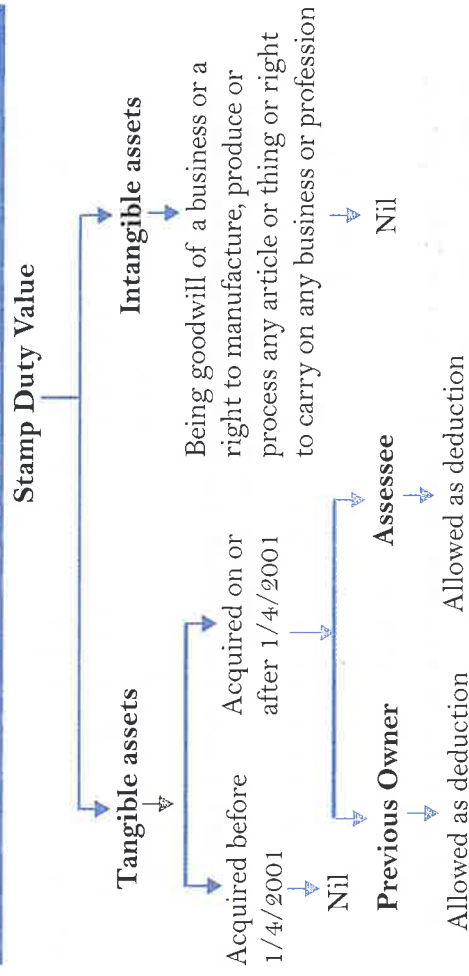

## 2nd Proviso to Sec 48 Indexed Cost of Acquisition & Improvement

Provisions of indexation will apply in case of long term capital gain on transfer of a long-term capital asset, other than capital gain arising to a non-resident from the transfer of shares in, or debentures of, an Indian company referred to in first proviso.

### 1) Index cost of acquisition

- Before 01/04/2001**  

$$\text{FMV on 1/4/2001 / COA to Assessee / Previous Owner, whichever is higher} \times \frac{\text{CII of the year of transfer}}{\text{CII of the year of acquisition}}$$
- After 01/04/2001**  

$$\text{COA to Assessee} \times \frac{\text{CII of the year of transfer}}{\text{CII of year of acquisition}}$$
- Asset acquired prior to 01/04/2001 by previous owner & received by Assessee prior to 01/04/2001**

FMV on 1/4/2001 / COA to Assessee / Previous Owner, whichever is higher  $\times$   $\frac{\text{CII of the year of transfer}}{\text{CII of the year of acquisition}}$



d) Asset acquired prior to 01/04/2001 by previous owner & received by Assessee after 01/04/2001

FMV on 1/4/2001 / COA to X CII of the year of transfer  
 Previous Owner, CII of year in which first  
 whichever is higher held by Assessee

e) Asset acquired after to 01/04/2001 by previous owner & received by Assessee after 01/04/2001

COA to X CII of the year of transfer  
 Previous Owner CII of year in which first  
 held by Assessee

**Manjula shah vs CIT :-** If assessee acquire CA by way of gift & transferred such assets, then ICA would be with reference to year in which previous owner held the assets & not in which Assessee becomes the owner. Therefore CII should be based on the year in which previous owner acquired the assets & not in which assessee becomes the owner

### Index cost of Improvement

COI X CII of the year of transfer  
 of the asset CII of the year in which improvement made by assessee/previous owner

(Any cost of improvement before 01.04.2001 whether by assessee or by previous owner is to be ignored)

Finance Act, 2016 has rearranged the Cost inflation Index:

FY	CII	FY	CII	FY	CII
2001-2002	100	2009-2010	148	2017-2018	272
2002-2003	105	2010-2011	167	2018-2019	280
2003-2004	109	2011-2012	184	2019-2020	289
2004-2005	113	2012-2013	200	2020-2021	301
2005-2006	117	2013-2014	220	2021-2022	317
2006-2007	122	2014-2015	240	2022-2023	331
2007-2008	129	2015-2016	254	2023-2024	348
2008-2009	137	2016-2017	264		

CG  
7.7

CA CS VIJAY SARDA  +91 89566651954

## Benefit of Indexation Not Available To

Nature of Long Term Capital Gain Transferred	Assessee not Eligible
Bond/debenture Except capital Indexed Bond issued by Govt/ Sovereign gold Bond	All Assessee
Shares/debenture of Indian Co. acquired by using convertible Forex	Non Resident
Depreciable Assets	All Assessee
Slum Sale	All Assessee
Securities covered u/s 112A	All Assessee
Units purchased in Foreign Currency u/s 115AB [Refer NR Taxation]	Offshore Fund
GDR purchased in Foreign Currency u/s 115AC/115ACA [Refer NR Taxation] Securities given u/s 115AD [Refer NR Taxation]	NR/ Resident Individual

## 1st Proviso To Sec 48 Capital Gain in Case of Non Resident

In case of :

Assessee who is a NR (Includes foreign company) Assets should be shares or debentures of Indian Company & Such Asset was acquired in foreign currency by way of purchase of reinvestment then CG shall be calculated in foreign currency & after that it shall be reconverted into Indian Currency.

### RULE 115A - METHOD OF CONVERSION

Sale Consideration	Avg of TTBR & TTSR	On date of transfer
COA	Avg of TTBR & TTSR	On date of acquisition
Transfer Expense	Avg of TTBR & TTSR	On date of transfer
CG into INR	TTBR	On date of transfer

### 3rd Proviso To Sec 48

First & second proviso NOT APPLICABLE for computation of LTCG in case of Equity shares, Equity oriented units, units of Business Trust referred u/s 112A.

www.ekatvamacademy.com/ www.vlearnclasses.com



## 4th Proviso To Sec 48

Index benefit not allowed in case of bonds/debentures except Capital Indexation Bonds & Sovereign Gold Bonds issued by RBI. As per Sec 47, NO CG in case of Individual on redemption of Sovereign Gold Bond issued by RBI

**Individual** { **Redemption on Maturity** — No CG due to Sec 47

**Transfer before Maturity** — CG Apply (Index available)

**Other Assessee** : CG on transfer or Maturity & index benefit available.

## 5th Proviso To Sec 48 Foreign Exchange Fluctuation

- Any gain arising on Rupee Appreciation against Foreign currency at time of redemption of RDB (Rupee denomination bonds) of Indian Company, shall be ignored for calculation of FVOC in case of NR Assessee
- For CG Computation - First Proviso to Sec 48 applies
- If there is loss due to Rupee depreciation, then it shall be allowed as Capital loss & can be set off & c/f
- Exemption is not available if RDB is transferred before maturity
- Exemption is available to any person who holds the bond i.e. even a secondary holder as well.

## 6th Proviso To Sec 48 Deemed Consideration

Where shares, debentures & warrants are transferred under the gift or an irrevocable trust, the market value as on date of such transfer shall be deemed to be Full value of consideration.

## CG Exempt u/s 10

Section	Detailed provisions
10(34A)	Any transfer upon buy back of shares of an domestic company shall be exempt in the hands of shareholder
10(43)	CG exempt if received under Reverse Mortgage Scheme.
10(37)	CG on compulsory acquisition of urban agricultural land > Assessee is Individual/HUF > Such Land was used at least 2 years prior transfer for agricultural purpose > Acquired by way of compulsory acquisition > Received after 2004
10(37A)	Transfer of Land/Building/Both after 02-06-2014 under Andhra Pradesh capital city land pooling scheme > Assessee is individual or HUF > Owns a Land/building under Andhra Pradesh capital city land pooling scheme > Ownership certificate is issued under the scheme > Any CG on account of transfer shall be exempt.

## Sec 112A Tax On Long Term Capital Gain [Sec 10(38) Abolished]

### LTCG on transfer of:

- > Equity Shares, or
- > Equity Oriented Units, or
- > Units of Business Trust,
- > Any ULIP issued on or 1.2.2021, to which exemption u/s 10(10D) does not apply an account of-

1) Premium payable exceeding ₹ 2,50,000 for any of the previous years during the term of such policy; or

2) The aggregate amount of premium exceeding 2,50,000 in any of the PY during the term of any such ULIP(s), in case where premium is

payable by a person for more than one ULIP issued on or after 1.2.2021 In excess of ₹ 1L shall be taxable @ 10% (+ HEC @ 4%) if following conditions are satisfied:

- STT paid on Acquisition & transfer of Equity Shares
- STT paid on transfer of Equity Oriented Units & Units of Business Trust

CG  
7.8



- > If the above conditions are not satisfied, Sec 112 is still applicable
- > Rebate u/s 87A is not available (applicable) from LTCG u/s 112A

Particulars	Amount
FVC = Amount received	xxx
(-) Expenses on Transfer	(xxx)
<b>Net Consideration</b>	xxx
(-) COA : Higher of	(xxx)
a) COA	
b) Lower of :	
i) Sale Consideration	
ii) FMV as on 31.1.18	
<b>Capital Gain</b>	xxx

**FMV :**

**Listed & Traded on 31.1.18** - Highest Price on that Day

**Listed but not traded** - Highest Price on any Previous Traded Day

**Units**

**Unlisted Shares** - NAV as on 31.1.18  
- Indexed Cost (17-18)

### Notification 60/2018 Exception To STT Payment

- 1) Shares acquired prior to 1<sup>st</sup> Oct 2004
- 2) Acquisition of share approved by HC, SC, NCLT, SEBI, & RBI
- 3) Shares acquired by NR under FDI guidelines
- 4) Acquisition of shares by Investment fund u/s 115 UB
- 5) Shares acquired through preferential issue as per SEBI
- 6) Acquisition through an issue of share by company
- 7) Acquisition by schedule Bank, Reconstruction, or securitisation company or PFI during ordinary course of business
- 8) Acquisition under ESOP
- 9) Acquisition under SEBI
- 10) Acquisition from Government
- 11) Acquisition by any mode of transfer [45(3)/45(4)/47/50B] if the previous owner has acquired shares by any of the mode

### Press Note DT. 20th Sept 2019

Enhanced Surcharge rate shall not apply to CG arising out of Sale of equity share or equity oriented fund or units of business trust in hands of I/HUF/AOP/BOI/AJP.

Enhanced Surcharge shall not apply to CG arising on sale of security including derivative in hands of Foreign Portfolio investor

### Circular No. 743 Unlisted Deposit Under CGAS In The Hands Of Legal Heirs

It is clarified that unutilized deposit under CGAS, 1988 cannot be taxed in hands of deceased. This amount is not taxable in hands of legal heirs also for unutilised portion of deposit does not partake the character of income in their hands but only a part of estate devolving upon them.

### Circular No 667

Land is an integral part of the Residential House, hence exemption u/s 54 is available for the same.

CG  
7.9

CA CS VIJAY SARDA  +91 8956651954

[www.ekatvacademy.com/www.vlearnclasses.com](http://www.ekatvacademy.com/www.vlearnclasses.com)

# Exemption u/s 54

Particulars	Sec 54	Sec 54B	Sec 54D	Sec 54EC	Sec 54F
<b>Eligible Asset transferred</b>	Individual/ HUF Residential House (LTCA)	Individual/ HUF Urban Agricultural Land	Any assessee Land & building forming part of an industrial Undertaking	Any assessee Land or building or both (LTCA)	Individual/ HUF Any LTCA other than Residential House
<b>Other Conditions</b>	Income from such house should be chargeable under the head "Income from house property"	Land should be used for agricultural purposes by assessee or his parents or HUF for 2 years immediately preceding the date of transfer	Land & building have been used for business of undertaking for at least 2 years immediately preceding the date of transfer. The transfer should be by way of compulsory acquisition of the industrial undertaking	Bonds of NHAI or RECL or any other bond notified by CG. (Redeemable after 5 years)	Assessee should not own more than one residential house on the date of transfer. He should not purchase within 2 years or construct within 3 years after the date of transfer, in another residential house
<b>Qualifying asset i.e., asset in which CG has to be invested</b>	One Residential House situated in India/Two residential houses in India, at the option of the assessee, where CG does not exceed ₹ 2 crore	Land for being used for agricultural purpose (Urban/Rural)	Land or Building or right in land or building	Bonds of NHAI or RECL or any other bond notified by CG. (Redeemable after 5 years)	One Residential House situated in India

Particulars	Sec 54	Sec 54B	Sec 54D	Sec 54EC	Sec 54F
<b>Time limit for purchase/construction</b>	Purchase within 1 yr before or 2 years after the date of transfer (or) construct within 3 years after the date of transfer	Purchase within a period of 2 years after the date of transfer	Purchase/construct within 3 years after the date of transfer, for shifting or re-establishing the existing undertaking or setting up a new industrial undertaking.	Purchase within a period of 6 months after the date of transfer	Purchase within 1 year before or 2 years after the date of transfer (or) Construct within 3 years after the date of transfer
<b>Amount of Exemption</b>	Cost of new Residential House or two houses, as the case may be or CG, whichever is lower, is exempt. However, if the cost of new residential house exceeds ₹10 crore, the amount exceeding ₹ 10 crore would not be taken into account for exemption. The maximum exemption that can be claimed by the assessee is ₹ 10 cr	Cost of new Agricultural Land or Capital Gain, whichever is lower, is exempt	Cost of new asset or Capital Gain, whichever is lower	Capital Gain or amount invested in specified bonds, whichever is lower. Maximum permissible investment out of capital gains arising in any financial year is ₹50 lakhs, whether such investment is made in the current FY or subsequent FY or both.	Cost of new Residential House $\geq$ Net sale consideration of original asset, entire Capital gain is exempt. Cost of new Residential House $<$ Net sale consideration of original asset, proportionate capital gain is exempt. However, if the cost of new residential house exceeds ₹ 10 crore, the amount exceeding ₹10 cr would not be taken into account for exemption

CG  
7.10



## Sec 51 Forfeiture of Advance Received

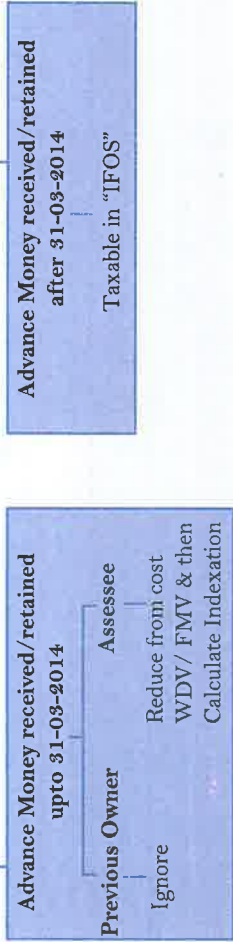

## Exception To Sec 45

- 1) Insurance Compensation on destruction of asset [Sec 45(1A)]
- 2) Conversion of Capital Asset into stock in trade [Sec 45(2)]
- 3) Transfer of Securities by depository [Sec 45(2A)]
- 4) Transfer of Capital Asset by partner/member of AOP/BOI [Sec 45(3)]
- 5) Distribution of CA of Dissolution of Firm, AOP, BOI [Sec 45(4)]
- 6) Capital Gain in case of compulsory acq of CA [Sec 45(4)]
- 7) Registered Re-developer agreement [Sec 45(5A)]

## Sec 45(1A) Insurance Compensation

Where CA is destroyed due to Fire, flood, earthquake, Tsunami, riots, civil disturbance, action of enemy then the provision is applicable, if compensation is received.

### Non-Depreciable Assets

Full Value of consideration	Amount Received in year of Receipt	xxx
Exp on Transfer	As Usual	(xxx)
Net Consideration		xxx
COA / ICOA	As Usual: But Indexation only upto destruction year	(xxx)
Capital Gain/Loss		xxx

### Depreciable Assets

Full Value of Consideration	Amount Received in year of Receipt
WDV	
STCG/STCL	

### Note:

- 1) Insurance monies for loss of raw material shall be treated as normal trading receipt as raw material is not a 'capital asset', however, it may be taxable as trading receipt u/s 28 or 56
- 2) Where any asset is destroyed & no insurance compensation is received, it shall be treated as a dead loss, because neither sec 45(1) nor sec 45(1A) get attracted.

## Sec 45(2) Conversion of CA Into Stock in Trade

### Note:

- 1) Both Income will arise when Converted stock is sold. Indexation is available only upto the year of conversion.
- 2) If any part of stock is sold then only part CG shall arise in year of sale
- 3) In case of converted stock sale, period of 6M shall calculate from date of sale of stock for claiming deduction exemption u/s 54EC

Capital Gain		PGBP	
FVC= FMV as on date of Conversion [Taxable when Converted stock is sold]	xxx	Sale Value [Taxable in the year when converted stock is sold]	xxx
Less: Exp on Transfer	(xxx)	Less: FMV as on the date of Conversion	(xxx)
Net Consideration (as usual)	xxx	PGBP	xxx
Less: COA/ICOA(as usual) (Indexation only upto the year on conversion)	(xxx)	Conversion of Stock in Trade into Capital Asset Shall be charged under the head "PGBP"	
Less: COI/ICOI(as usual) (Indexation only upto year on conversion)	(xxx)		
CG	xxx		
Less: Exemption u/s 54 series	(xxx)		
CG	xxx		

## Sec 45(1B) ULIP Receipts

> Where any person receive at any time during the PY, any amount under the ULIP issued on or after 01.02.2021, to which exemption u/s 10(10D) does not apply on account of

- 1) Premium payable exceeding 2,50,000 for any of the PY's during the term of such policy; or
- 2) The aggregate amount of premium exceeding 2,50,000 in any of the PY during the term of any such ULIP(s), in case where premium is payable by a person for more than one ULIP issued on or after 1.2.2021

Then any profit arising from receipts of such amount by such person shall be chargeable to tax under the head capital gains & shall be deemed to be Income of PY in which such amount was received the Income taxable shall be calculated in such manner as may be prescribe.

## Sec 45(5) Compulsory Acquisition

Initial Compensation	
FVC= Total Compensation received [Even is part consideration is received whole amount is taxable]	XXX
Less: Exp on Transfer	(XXX)
Net Consideration (as usual)	XXX
Less: COA/ICOA(as usual) (Indexation only upto year on compulsory Acq)	(XXX)
Less: COI/ICOI(as usual) (Indexation only upto year on conversion)	(XXX)
CG	XXX
Less: Exemption u/s 54 series	(XXX)
CG	XXX

Enhanced Compensation	
FVC= Amount received	XXX
Less: Exp on Transfer	(XXX)
Net Consideration	XXX
Less: COA/ICOA	NIL
Less: COI/ICOI	NIL
CG	XXX

## Notes :

- 1) Nature of CG w.r.t enhanced compensation shall be same as nature of CG computed w.r.t original compensation.
- 2) Legal expenses incurred to obtain enhanced compensation are deductible from enhanced compensation & balance shall be CG
- 3) Compensation received in respect of award/agreement u/s 96 of Right to fair Compensation & Transparency in land Acq Rehabilitation & Resettlement Act'13 shall not be taxable.

## Sec 45(5A) Registered Developer Agreement

Assessee being Individual & HUF, who enter into specific agreement for development of project then, in the year of certificate of completion of whole or part of the project is issued by competent authority shall be chargeable to tax.

FVC = Stamp Duty Value of his share on date of issue of certificate + consideration received in cash	XXX
Less: Exp on Transfer	(XXX)
Net Consideration (as usual)	XXX
Less: COA /ICOA	(XXX)
Less: COI/ICOI	(XXX)
CG	XXX
Less: Exemption u/s 54 series	(XXX)
CG	XXX

## My Note :

- a) Chargeable in PY in which completion certificate for whole or part of the property is issued by competent authority.
- b) Non Applicability of above provision-

In case assessee transfers his share in project on before date of issue of said certificate of completion & CGs will be charged in PY in which transfer took place & normal provisions of CGs shall apply

## Reduction of compensation:

Where comp. is reduced by CG then Gain shall be recomputed. Interest on Compensation & Enhanced is Taxable under IFOS & u/s 57: 50% of Interest shall be allowed as deduction.

CG  
7.12



## Sec 50B Slump Sale

FMV determined in prescribed manner	XXX
Less: Net Worth [Deemed cost of acquisition]	(XXX)
CG	XXX

<b>Net Worth</b>	Total Assets ( - ) Current Liability									
	Note: If net worth is negative, it is taken as equal to zero & sale consideration will become CG - <i>Zuari Inds. Ltd. v. CIT (Mum.)</i>									
<b>Aggregate value of total assets</b>	<table border="1"> <tr> <td>Depreciable Assets</td> <td>- WDV</td> <td>Revaluation of Assets are totally Ignored</td> </tr> <tr> <td>Other Assets</td> <td>- Book Value</td> <td></td> </tr> <tr> <td>100% deduction Claimed assets</td> <td>- Nil</td> <td></td> </tr> </table>	Depreciable Assets	- WDV	Revaluation of Assets are totally Ignored	Other Assets	- Book Value		100% deduction Claimed assets	- Nil	
Depreciable Assets	- WDV	Revaluation of Assets are totally Ignored								
Other Assets	- Book Value									
100% deduction Claimed assets	- Nil									

### Important Points :

- 1) If Networth is negative - COA is NIL
- 2) If Deduction u/s 35AD is claimed on asset then COA = NIL
- 3) Assessee shall furnish a report from CA certifying Networth.
- 4) Gain is long term if unit held for more than 3 years.
  - > **FMV shall be determined as per Rule 11 UAE which shall be higher of FMV1 or FMV2 whichever is higher (Covered at Finals Level)**

## Sec 46 Capital Gain On Liquidation

**Sec 46(1)** - Where a company in liquidation distribute capital Assets on its liquidation there will be No capital gain in the hands of company

**Sec 46(2)** - Where a shareholder on the liquidation receives any money or other assets from the company, it is taxable to CG  
 FVOC = FMV / Money Received (-) Deemed Dividend u/s 2(22)(e)

## Sec 47 Transaction not regarded as Transfer

Sec	Provision
47(i)	Any distribution on the total or partial partition of a HUF
47(iii)	Any transfer under a gift or will or an irrevocable trust
47(iv)	Any transfer by a company to its subsidiary company
47(v)	Any transfer by a subsidiary company to the holding Co.
47(vi)	Any transfer by the amalgamating company to the amalgamated company, in a scheme of amalgamation
47(via)	Any transfer by the amalgamating foreign company to the amalgamated foreign company, in a scheme of amalgamation of two foreign companies
47(vib)	Any transfer, in a demerger, by the demerged company to the resulting company
47(vid)	Any transfer or issue of shares by the resulting company, in a scheme of demerger to the shareholders of the demerged Co.
47(viib)	Any transfer of a capital asset made outside India by a NR to another non-resident
47(viic)	Any transfer by way of redemption by an individual
47(ix)	Any transfer to the Government or to a University or the National Museum, National Art Gallery, National Archives or any other public museum or institution notified by the Central Government to be of national importance or to be of renown throughout any State
47(x)	Any transfer by way of conversion of bonds or debentures, debenture-stock or deposit certificates in any form, of a company into shares or debentures of that company
47(xa)	Any transfer by way of conversion of bonds into shares or debentures of any company
47(xb)	Any transfer by way of conversion of preference shares of a company into equity shares of that company
47(xvi)	Transfer of capital asset under Reverse Mortgage

## Sec 111A Tax On Short Term Capital Gain

If a person sale short-term capital asset, being an equity share in a company or a unit of an equity oriented fund or a unit of a business trust and STT is paid then Tax shall be:

- On STCG @ 15% and
- Other income - Applicable rate

**Special Adjustment for Residents:** In the case of an individual or a HUF, being a resident, where Assessee cannot absorb Basic exemption limit and has special Income then special income shall be 1st Adjusted towards basic Exemption limit and balance, if any, shall be chargeable at special rate. Transaction undertaken on a RSE located in any IFSC and where the consideration for such transaction is paid or payable in foreign currency then even if STT is not paid then also section is applicable.

**Sec 111A(2):** Where the gross total income of an assessee includes any STCG, the deduction u/c VI-A shall be allowed from the gross total income as reduced by such capital gains.

## Sec 112 Tax On Long Term Capital Gain

### Tax rate for Individual / HUF

Normal Income - Normal Slab Rate  
LTCG - 20%

### Special Adjustment:

If Assessee(resident) cannot absorb basic exemption limit and has special Income viz LTCG u/s 112/112A or STCG u/s 111A such special income shall be first adjusted towards Basic exemption limit and balance income if any shall be Taxable at special rate

### Tax rate for Domestic Company

- Other Income - Normal rate applicable to Company
- LTCG - 20%

### Tax rate for Other Than Individual

LTCG - 20%

CG  
7.14

CA CS VIJAY SARDA  +91 8956651954

## Tax rate for NR/FC

- Unlisted shares/ Shares or Private company - 10% (Without Giving Indexation)(1<sup>st</sup> provisio to Sec 48)
- LTCG - 20%

## No Deduction under Chapter VIA:

No deduction under Chapter VIA is applicable in case of LTCG u/s 112.

Case Laws		
<b>Syed Ali Adil</b>	Case: would assessee be entitled to exemption u/s 54 in respect of Purchase of 2 house adjacent to each other having common entrance	Held: Yes if it has common entrance
<b>Kamakl Wahal</b>	Case: can exemption be withdrawn on the grounds that new flat was purchased in the name of wife	Held: No
<b>CIT v. Arvinda Reddy</b>	Case: Property owned by more than one person & other Co-owner/(s) release respective share/interest in property in favour of one of the co-owner, can it be considered that the property is purchased be releasee & exemption be claimed u/s 54?	Held: Yes, Releasee fulfills condition of Sec 54 as to purchase so far as release assessee is concerned
<b>CIT v. Narasimhan (PV) (Mad.)</b>	Case: Assessee sold residential property & invested CG within stipulated time in construction of a new floor on another house owned by him by demolishing existing floor. Is it entitled for deduction u/s 54?	Held: Yes
<b>CIT v. JR Subramanya Bhart (Karn)</b>	Case: Construction of new house may start before date of transfer but it is to completed within 3 years from date of original transfer. Is it eligible for deduction u/s 54?	Held: Yes
<b>CIT v. Shahzada Begum (AP)</b>	Case: Assessee has paid full consideration & obtained the possession of the house within the specified period, but the sale deed is not been registered in his favor. Is he eligible for exemption u/s 54?	Held: Yes
<b>Gurnam Singh</b>	Case: Can exemption u/s 54B be denied on the grounds that assessee is co owner	Held: Exemption shall be Available
<b>Hindustan Unilever</b>	Case: can exemption be withdrawn u/s 54EC if invt is made within 6 month but bond issued after 6M	Held: Yes
<b>Rajiv Shukla</b>	Case: can exemption be available if asset is depreciable assets u/s 54F	Held: Yes
<b>Fiber Boards</b>	Case: can advance given for purchase of P&M, L&B qualify for exemption u/s 54G	Held: Yes

www.ekatvamacademy.com/ www.vlearnclasses.com



### P1. Based on Computation of LTCG

Mr. Dinesh received a vacant site as gift from his friend in November'08. The site was acquired by his friend for ₹3L in April'06. Dinesh constructed a residential building during the year 2010-11 in the said site for ₹1.5L. He carried out some further extension of construction in 2013-14 for ₹5L. Dinesh sold the residential building for ₹5.5L in January'24 but the State stamp valuation authority adopted ₹6.5L as value for the purpose of stamp duty. Compute his LTCG, for the AY 24-25 based on the above information. The cost inflation indices are as follows:

FY	CII	FY	CII
2006-07	122	2013-14	220
2008-09	137	2023-24	348
2010-11	167		

### P2. Based on sec 54EC

Ms. Anshu transfers land & building on 02-01-2024 & furnishes the following:

Sale consideration received – ₹ 18L

Value adopted by Stamp Valuation Authority – ₹22L

Value ascertained by Valuation Officer on reference by the A.O – ₹24L

This land was acquired by Anshu on 1-04-2001 & FMV was – ₹1.1L

Anshu constructed a residential building on land at a cost of ₹3.2L

(construction completed on during FY 2008-09) Brought forward

STCL incurred on sale of shares during FY 2020-21 ₹1.5L, Anshu

seeks your advice regarding the amount to be invested in NHAI

bonds so as to be exempt from CG tax under the Income-tax Act,

1961. Cost inflation index for FY 01-02 : 100; FY 08-09 : 137;

FY 2023-24 : 348

### P3. Based on Default tax Regime 115BAC

Mr. Mithun purchased 100 equity shares of M/s Goodmoney Co. Ltd. on 01-04-2007 at rate of ₹ 1,000 per share in public issue of the company by paying securities transaction tax. Company allotted bonus shares in the ratio of 1:1 on 01.12.2022. He has also received dividend of ₹ 10 per share on 01.05.2023. He has sold all the shares on 01.10.2023 at the rate of ₹ 4,000 per share through a recognized stock exchange and paid brokerage of 1% and securities transaction tax of 0.02%. Compute his total income and tax liability for A.Y. 2024-25 if Mr. Mithun pays tax under default tax regime, assuming that he is having no income other than given above. Fair market value of shares of M/s Goodmoney Co. Ltd. on 31.1.2018 is ₹ 2,000.

### P4. Computation of Capital Gain

Mr. Sarthak entered into an agreement with Mr. Jaikumar to sell his residential house located at Kanpur on 16.08.2023 for ₹ 1,50,00,000.

The sale proceeds were to be paid in the following manner:

- (i) 20% through account payee bank draft on the date of agreement.
- (ii) 60% on the date of the possession of the property.
- (iii) Balance after the completion of the registration of the title to the property.

Mr. Jaikumar was handed over the possession of the property on 15.12.2023 and the registration process was completed on 14.01.2024. He paid the sale proceeds as per the sale agreement.

The value determined by the Stamp Duty Authority-

- (a) On 16.08.2023 was ₹ 1,70,00,000;
- (b) On 15.12.2023 was ₹ 1,71,00,000; and
- (c) On 14.01.2024 was ₹ 1,71,50,000.

Mr. Sarthak had acquired the residential house at Kanpur on 01.04.2001 for ₹ 30,00,000. After recovering the sale proceeds from Jaikumar, he purchased two residential house properties, one in Kanpur for ₹ 20,00,000 on 24.3.2024 and another in Delhi for ₹ 35,00,000 on 28.5.2024. Compute the income chargeable under the head "Capital Gains" of Mr. Sarthak for the Assessment Year 2024-25.

Cost Inflation Index for F.Y.(s): 2001-02 - 100; 2023-24 - 348

**P5. Based on Computation of Capital Gain**

Mr. Rakesh purchased a house property on 14th April'03 for ₹1,05,000. He entered into an agreement with Mr. Bobby for the sale of house on 15th September'03 & received an advance of ₹25,000. However, since Mr. Bobby did not remit the balance amount, Mr. Rakesh forfeited the advance. Later on, he gifted the house property to his friend Mr. Aakash on 15th June'10. Following renovations were carried out by Mr. Rakesh & Mr. Aakash to the house property:

By Mr. Rakesh during F.Y. 2003-04 – ₹10,000

By Mr. Rakesh during F.Y. 2007-08 – ₹50,000

By Mr. Aakash during F.Y. 2017-18 – ₹1,50,000

The fair market value of the property as on 1.4.2001 is ₹1,50,000.

Mr. Aakash entered into an agreement with Mr. Chintu for sale of the house on 19th June'10 & received an advance of ₹1L. The said amount was forfeited by Mr. Aakash, since Mr. Chintu could not fulfill the terms of the agreement. Finally, the house was sold by Mr. Aakash to Mr. Sanjay on 2nd January'24 for a consideration of ₹25L. Compute the CG chargeable to tax in the hands of Mr.

Aakash for the AY 2024-25. [CII: 03-04:109, 10-11:167, 07-08:129, 17-18:272, 23-24:348]

**P6. Based on Sec 54**

Mr. Sagar, a resident individual acquired a plot of land at a cost of ₹75,000 in June'12. He constructed a house for his residence on that land at a cost of ₹1.25 in the FY 2014-15. He transferred the house for ₹15L in May'23 and acquired another Residential house in June'23 for ₹8L. He furnishes other particulars as under:

Insurance agency commission earned	₹45,000
(Net of TDS of ₹5,000)	
Investment in NSC VIII issue	₹20,000 (i.e. on 20-3-24)

Compute the total income of Mr. Sagar for the AY 2024-25

**P7. Based on sec 54**

Mr. Anand P a resident individual age 55 years purchased 10 plots in FY 2006-07 for ₹12L. On 1st April'06 he started the business of property dealing & converted all plots as stock in trade for his business & recorded the cost of property ₹40L in books being the FMV as on 1st April. On 31st March'13, he sold all 10 plots for ₹55L & purchased residential house for ₹50L. He has constructed 2 rooms in residential house in June'14 & has spent ₹8L. He sold the above Residential House in PY for ₹70L, the stamp value authority adopted the value for stamp Duty ₹92L. on request of Mr. Anand reference to valuation officer was made & VO determined the value ₹95L. he paid brokerage of 1%. Compute the Capital gain and Tax Liability.



# Chapter 8 PROFITS & GAINS FROM BUSINESS/PROFESSION

Sr No.	Particulars	Pg No	Sec	Particulars	Pg No
1	Sec 28 Charging Section	8.2	31	Sec 35CCD Expense on Skill development	8.10
2	Sec 37 General deductions	8.2	32	Sec 35CCA Expense for Rural Development Programmes	8.10
3	Sec 40A(2) Payment to relative	8.3	33	Sec 35D Preliminary Expense	8.10
4	Sec 40A(3) Cash expenditures	8.3	34	Sec 35DD Amalgamation and Demerger expenses	8.10
5	Rule 6ABBA Other electronic mode	8.3	35	Sec 35DDA Expenditure related to VRS	8.11
6	Rule 6DD Exception to 40A(3)	8.3	36	Sec 35AD Deduction of certain specified business	8.11
7	Sec 40A(4) Payment by prescribed mode in violation of contract	8.3	37	Sec 43B Deduction allowed on Actual Payment basis	8.11
8	Sec 269ST Mode of undertaking transactions	8.4	38	Sec 36 Other deductions	8.12
9	Sec 271DA Penalty for failure to comply with provisions of sec 269ST	8.4	39	Sec 40(a)(i)/(ia) Payment made without TDS	8.14
10	Sec 40A(7) Disallowance In Respect of Provision for Gratuity	8.4	40	Sec 40(a)(ib) Equalization levy	8.14
11	Sec 40A(9) Disallowance on Contribution To Non Statutory Funds	8.4	41	Sec 40(a)(iib) Fee/Charge paid by state Govt Undertaking	8.14
12	Sec 38 Partly used for Business & profession	8.4	42	Sec 40(b) Payment To Partners	8.14
13	Sec 30 & 31 Rent, rates & taxes	8.4	43	Remuneration	8.14
14	Sec 32 Depreciation	8.4	44	Interest	8.15
15	1st proviso Depreciation in case of Amalgamation	8.4	45	Sec 41 Deemed PGBP	8.15
16	Rate of Depreciation	8.5	46	Sec 44AA Maintenance of Books of accounts	8.16
17	Sec 43(1) Actual Cost	8.5	47	Sec 2(12A) Books or Books of Account	8.16
18	Sec 50 Capital Gain of depreciable asset	8.6	48	Sec 145 Method of Accounting	8.16
19	Sec 32(1)(ia) Additional Depreciation	8.7	49	Sec 44AB Audit of accounts	8.16
20	Sec 32(2) Set off & c/f of depreciation	8.7	50	Sec 43CA Special provision for full value of consideration for transfer of assets other than capital assets in certain cases.	8.17
21	Format to Solve Depreciation	8.8	51	Sec 44AD Presumptive Taxation	8.17
22	Sec 32(1)(i) Depreciation in case of Power Generation Unit	8.8	52	Sec 44AE Presumptive Taxation For GTA	8.17
23	Sale of asset of power generating unit	8.8	53	Sec 145B Taxability of Certain Income	8.17
24	Sec 35 Expenditure On Scientific Research	8.9	54	Sec 44ADA Presumptive Taxation For Professional	8.18
25	Sec 234G Fees for Default in Filing Statement	8.9	55	Sec 43(5) Speculative Transaction	8.18
26	Sec 271K Penalty for failure to furnish statements	8.9	56	Payment Without TDS	8.18
27	Sale of Scientific Research Assets	8.9	57	Unsolved Questions	8.19
28	Sec 35(2AA) Donation to national laboratory /IIT	8.9			
29	Sec 35(2AB) Assessee engaged in Manufacturing/biotechnology	8.10			
30	Sec 35CCC Expenses on Agriculture Extension project	8.10			

PGBP  
8.1

CA CS VIJAY SARDA +91 8956651954



www.ekatvacademy.com/www.vlearnclasses.com

## Sec 28 Charging Section

**Following Income shall be taxable under the head PGBP :**

- 1) Any profit/gain of any Business/Profession
- 2) Profit on sale of Import Entitlement License
- 3) Cash Compensatory support or duty drawback
- 4) Profit on sale of DEPB (Duty entitlement pass book scheme)/Duty free Replenishment Certification (DFRC)
- 5) Any Amount received under Key-Man Insurance Policy
- 6) The value of any benefit or perquisite arising from business or the exercise of any profession, whether –
  - Convertible into money or not or
  - In cash or in kind or partly in cash and partly in kind. [FA 2023]
- 7) Any Interest, salary, bonus, commission received by partner from Partnership firm [to extent allowed u/s 40(b) to firm]
- 8) Non-compete Fees (not carrying out any activity in relation to any business or profession or not sharing any know-how, patent, copyright, trade-mark etc.)
- 9) Income derived by a trade, professional or similar association from specific service perform for its member
- 10) FMV of inventory as on date on which it is converted into CA.
- 11) Any Compensation or other payment due to/received by, any person, at or in connection with termination/modification of terms & conditions, of any contract relating to his business
- 12) Sale of Asset whose whole cost is allowed as deduction

## Sec 37 General Deductions

Any expenditure which is not specifically under Sec 30 to 36 & fulfills following conditions, shall be allowed as deduction under this sec.

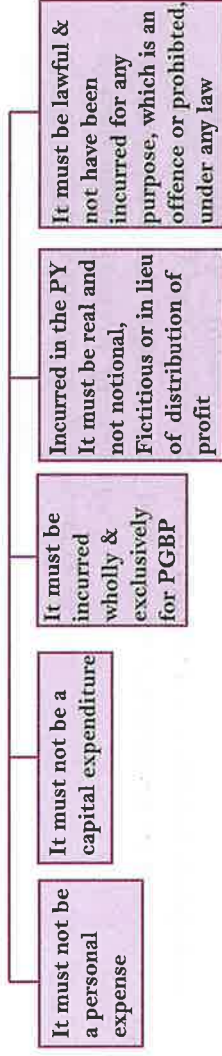

**Illegal expenses are not allowed:** any expenditure the purpose of which is an offence or is prohibited by law shall not be deemed to have been incurred for the purpose of business or profession. [Expln. 1]

**Explanation 3:** "Expenditure which is an offence or which is prohibited by law" shall include and shall be deemed to have always included the Expenditure incurred by an assessee -

1. For any purpose which is an offence or which is prohibited by, any law for the time being in force, in India or outside India; or
2. To provide any benefit or perquisite, in whatever form, to a person, whether or not carrying on a business or exercising a profession, and acceptance of such benefit or perquisite by such person is in violation of any law or rule or regulation or guideline, as the case may be, for the time being in force, governing the conduct of such person; or
3. To compound an offence under any law for the time being in force, in India or outside India. [FA 2023]

### Section 37(2B) :

1. Deduction shall not be given in respect of advertisement in any souvenir, brochure, pamphlet or the like published by a political party. However deduction for same is allowed u/s 80GGB/80GGC any other advertisement expenditures are allowed u/s 37(1)
2. Expenses related to CSR referred u/s 135 of the Companies Act, 2013 shall not be allowed. Donations to Swacch Bharat Kosh & Clean Ganga Project form part of CSR spends. Hence, disallowed in PGBP but allowed in 80G.



## Sec 40A(2) Payments to Relatives

**Sec 40A(2)** Where the assessee incurs any expenditure in respect of which payment has been or is to be made to **Specified person** (Relative or close associate) & AO is of opinion that such expenditure is excessive or unreasonable having regard to -

- 1) Fair market value of the goods, services or;
- 2) Legitimate Needs of Business or;
- 3) Benefit derived in Business so much of the expenditure as is so considered by him to be excessive or unreasonable shall be disallowed while computing PGBP.

## Sec 40A(3) Cash Expenditure

APPLICABILITY	NON APPLICABILITY - Rule 6DD
Expenses in cash exceeding 10,000 in a single day to same person shall not be allowed as deduction	<ol style="list-style-type: none"> <li>1. Payment made when bank is closed</li> <li>2. Payment to Banks, FI, Govt, Co-op bank.</li> <li>3. Payment to farmer for its produce</li> <li>4. Payment made at a place not served by Bank</li> <li>5. Payment is made by Dr. / cr. card, NEFT, Net banking, IMPS, BHIM.</li> </ol>
Note : for GTA take 35,000	

## Rule 6ABBA Other Electronic Mode

1. Credit card, Debit card
2. Net Banking, RTGS, NEFT, IMPS
3. UPI (Unified Payment Interface)
4. BHIM(Bharat Interface for Money) aadhar pay.

## Rule 6DD - Exception to Sec 40A(3) & (3A)

**No disallowance u/s 40A(3)/40A(3A) shall be made in following cases -**

- a) Where the payment is made to the RBI/Government
- b) Where payment is made to LIC, & other financial institution
- c) Payment made through NEFT/RTGS/Dr Card/Cr.card/UPI or BHIM (Rule 6ABBA)
- d) Payment made where banking facility is not available
- e) Payment made to farmer for agriculture/forest/fish/fish product
- f) Payment made to EE for retirement benefit upto 50,000
- g) Payment made for purchase of foreign currency
- h) Salary to employee posted at other place for 15 days/more.
- i) To authorised Money Changer for foreign currency
- j) Where the payment is made by way of adjustment against the amount of any liability incurred by the payee for any goods supplied/services rendered by the assessee to such payee;
- k) Where payment is made for purchase of products manufactured or processed without the aid of power in a cottage industry, to producer of such products;
- l) Where the payment is made in a village or town not served by any bank.
- m) Where the payment is made by any person to his agent who is required to make payment in cash for goods or services on behalf of such person;

## Sec 40A(4) Payment by prescribed mode in violation of contract

Notwithstanding anything contained in any other law for the time being in force or in any contract, where any payment is made as per prescribe mode u/s 40A(3) in order that such expenditure may not be disallowed as a deduction, then no person shall be allowed to raise, in any suit or other proceeding, a plea based on the ground that the payment was not made or tendered in cash or in any other manner.

## Sec 269ST Mode of undertaking transactions

**No person shall receive an amount of ₹ 2,00,000 or more -**

- In aggregate from a person in a day; or
- In respect of a single transaction; or
- In respect of transactions relating to one event / occasion from a person, otherwise than by an account payee cheque or an account payee bank draft or use of electronic clearing system through a bank account or through such other electronic mode as may be prescribed

**The provisions of this section shall not apply to-**

- Any receipt by-
  - Government
  - Any banking company, post office savings bank or co-operative bank;
- Transactions of the nature referred to in section 269SS;
- Such other persons or class of persons or receipts, which the Central Government may, by notification in the Official Gazette, specify.

**Notification 28/2017 - Notified Person by Government:** The provision of sec 269ST shall not apply to receipt by any person from any banking company, post office savings bank or co-operative bank.

## Sec 271DA Penalty for failure to comply with provisions of sec 269ST

If a person receives any sum in contravention of the provisions of sec 269ST, he shall be liable to pay, by way of penalty, a sum equal to the amount of such receipt. Provided that no penalty shall be imposed if such person proves that there were good and sufficient reasons for the contravention. Any penalty imposed above shall be imposed by the JC.

## Sec 40A(7) Disallowance In Respect of Provision For Gratuity

Disallowed Part	Allowed Part
Provision / payment to unapproved gratuity (Even if as per actuary)	Provision / payment to Approved Gratuity.

## Sec 40A(9) Disallowance on Contribution To Non Statutory Funds

Disallowed Part	Allowed Part
Provision / payment to unrecognized provident Fund	Provision / payment to: <ol style="list-style-type: none"> <li>RPF</li> <li>SPF</li> <li>Pension (80CCD)</li> <li>PPF</li> <li>Super Annuation Fund</li> </ol>

## Sec 38 Partly Used For Business & Profession



## Sec 30 & Sec 31

Section 30 Rent, rates and taxes of premises	Section 31 Insurance, repairs of plant, machinery & furniture (PMF)
Rent of the premises paid to others/Firm is allowed as deduction (for Tenant)	Rent of the PMF paid to others / Firm is allowed as deduction u/s 37
Insurance of premises is allowed as deduction	Insurance of PMF is allowed as deduction
Municipal tax, land revenue subject to Sec 43B is allowed as deduction.	
Current repairs is allowed as deduction. On capital repairs depreciation can be claimed.	Current repairs is allowed as deduction. On capital repairs depreciation can be claimed

## Sec 32 Depreciation

- Assets must be used for the purpose of business and profession
- Assets should be owned by assessee
- Depreciation should be allowed on the block of assets @ prescribed rate
- Assets must be Put to Use.





### Other Points :

- 1) No depreciation on goodwill be it purchased or self generated goodwill from A.Y. 21-22
- 2) 2nd proviso to Sec 32(1) - If assets is acquired In the PY & put to use for less than 180 days in the previous year then only 50% of depreciation shall be allowed.
- 3) In case of lease - Depreciation is always claimed by Lessor
- 4) Hire Purchase - Assessee can claim depreciation from the beginning
- 5) Expl. 1 to Sec 32 - Deemed Building - Where tenant incur capital expense on a building then it is treated as deemed building & depre is allowed to tenant
- 6) Expl. 5 to Sec 32 - Depreciation is mandatory
- 7) **Written Down Value - Sec 43(6):**

Particulars	₹
WDV of the block of assets* as on 1st day of the PY	XXX
(+) Actual cost of assets acquired during PY Sec 43[1]	XXX
(-) Sold, discarded, demolished/destroyed during PY. However, this reduction cannot, in any case, exceed value of asset computed above [actual sale price is reduced]	(XXX)
WDV	XXX
(-) Depreciation @ specified	(XXX)
Closing WDV	XXX

Actual Sales price shall be reduced from WDV & not its FMV.

[CIT v Cable Corp]

Sale price include insurance received, salvage/compensation received.

### 1st Proviso - Depreciation In Case of Amalgamation

<b>Step 1</b>	Calculate Total Depreciation as if no Amalgamation has taken Place
<b>Step 2</b>	Divide total Depreciation into No of days Used by Each Entity
<b>Days Counting:</b>	
<b>Old Assets</b>	- From 1st day of PY
<b>New Assets before Conversion</b>	- From the date of acquisition

## Rate Of Depreciation

Block	Nature of Assets	Rate
<b>Building</b>	Residential building other than hotels & boarding [Employee Quarter]	5%
	Non-residential building, godown, office, factory etc. including hotels and boarding	10%
<b>Furniture</b>	Temporary construction	40%
	Any furniture including electrical fittings	10%
<b>P&amp;M [Sec 43(3)]</b>	In general (if nothing is mentioned) Oil well	15%
	Motor car including lorries, buses, used for hiring purposes A.C.	30%
	> Computer including computer software	40%
	> Books owned by a professional. [whether annual publication or not]	
	> Energy saving device	
	> Annual Publication of books	
	> Life saving equipment	
> Windmill [before 01.04.2014 15%]		
> Pollution control equipment		
<b>Intangible</b>	Acquired after 31.3.1998	25%
	Ship/Vessel/speed boats	20%
<b>Other</b>	Aeroplanes	40%
	Motor bus/lorries on running them on hire	30%
	Renewable energy device installed after 31/03/2014	40%
	Renewable energy device installed before 31/03/2014	15%

### Notes:

Sec 43[3] P&M includes ships, vehicles, books, scientific apparatus & surgical equipment used for B&P but does not include:

- a) Tea bushes
  - b) Live stock
  - c) Building
  - d) Furniture & Fitting.
- Depreciation rate for computer accessories is also 40% [printer]

[CIT v BSES Yamuna Power ltd]

EPABX are not computer eligible for 15% [Federal Bank Ltd]

As per Explanation 5 to sec 32(1), depreciation shall be allowed to assessee whether/not he has claimed it in total income, because sec is mandatory.



## Sec 43(1) Actual Cost

Sr No	Particulars	Actual Cost
	Purchased	Purchase Price (+) Other costs incurred on assets put to use (-) Sale value Insurance Subsidy Assets acqd in cash exceeding ₹10,000 xxx xxx (xxx)
<b>Expl 1 to Sec 43(1)</b>	Acquired for Scientific research subsequently brought into business use	Actual Cost (-) Deduction availed u/s 35
<b>Expl 1A to Sec 43(1)</b>	Stock in trade is converted into capital asset.	Fair Market value on the date of transfer
<b>Expl 2 to Sec 43(1)</b>	Acquired by way of gift or inheritance.	WDV in the hands of previous owner at the of transfer.
<b>Expl 3 to Sec 43(1)</b>	Asset acquired at higher price from any other person using the asset for his business or profession with a view to claim depreciation on enhanced cost & reduce tax liability.	Actual cost to be determined by AO with prior approval of Joint Commissioner.
<b>Expl 4 to Sec 43(1)</b>	Asset once belonged to the assessee which was used by him for business & transferred & Reacquired by him.	The WDV at the time of original transfer or the price paid for Reacquiring the asset, whichever is less.
<b>Expl 4A to Sec 43(1)</b>	Asset acquired by an assessee from another person who had claimed depreciation on such asset & asset is leased back to such other person.	The WDV of the asset to the transferor at the time of transfer to the assessee.
<b>Expl 5 to Sec 43(1)</b>	Building used for private purpose subsequently brought into business use	The cost of purchase or construction of the building as reduced by the Notional depreciation calculated up to the year of bringing the asset to business use at the depreciation rate applicable to that year.

<b>Expl 6 to Sec 43(1)</b> <b>Expl 2 to Sec 43(6)</b>	Asset transferred by a holding Co. to its subsidiary Co. or by a Subsidiary Co., to holding Co. if the following two conditions are satisfied : i) Shares of the subsidiary Co. should be wholly owned the holding co. or its nominees. ii) The transferee co. should be an Indian company. Note: If transferor Co. was not claiming depreciation since it was not used for its business, then the actual cost to the transferee Co. shall be the actual cost to the transferor Co.	WDV to the transferor company will be adopted as the actual cost to the transferee company.
<b>Expl 7 to Sec 43(1)</b>	Transfer of asset in a scheme of amalgamation by amalgamating co to amalgamated Indian company. Note: If amalgamating Co was not claiming depreciation since it was not used for its business, then actual cost to the amalgamated co shall be the actual cost to amalgamating company.	WDV to the amalgamating company will be adopted as the actual cost to the amalgamated company.
<b>Expl 7A to</b>	Asset transferred by a demerged co to the resulting Indian co	Actual cost shall be the WDV in the hands of the demerged company.
<b>Expl 8 to</b>	Asset acquired out of borrowed funds	Interest on loan borrowed relating to the period after the asset is first put to use shall never form part of actual cost.
<b>Expl 9 to</b>	Asset acquired subject to levy of excise duty or customs duty in respect of which CENVAT credit is availed.	So much of the duty in respect in respect of which a claim of credit has been made & allowed under Central Excise Rules, 1944 shall not form part of the actual cost
<b>Expl 10 to</b>	A portion of the cost of an asset acquired is met directly or indirectly by Government or any statutory authority or any other person in the form of a Subsidy or grant or reimbursement.	So much of the cost as is relatable to such subsidy or grant or reimbursement shall not form part of the actual cost. If subsidy is not directly relatable to the asset acquired, but subsidy is with reference to the assets then the subsidy shall be proportionately reduced from the actual cost of the assets with reference to which subsidy has been granted.



<b>Expl 11 to Sec 48(1)</b>	Asset brought into India by NR/foreign co for use in his business or profession.	Actual cost as reduced by amount of depre calculated @ in force as if asset was used in India since the date of acquisition
<b>Expl 12 to Sec 48(1)</b>	Any capital asset acquired under a scheme of corporation of a recognised stock exchange in India, approved by SEBI.	The amount, which would have been regarded as actual cost, had there been no such corporation shall be deemed to be the actual cost.
<b>Expl 13 to Sec 48(1)</b>	Actual cost of capital asset has been allowed as deduction u/s 35AD and capital asset is transferred by way of transactions referred to in sec 47	The actual cost of such asset to the transferee shall be NIL.

## Sec 50 Capital Gain In Case of Depreciable Asset

Depreciable Asset is not eligible for indexation. Hence, the gain will always be STCG. If asset is stolen or damaged & no insurance compensation is received.

**There are other assets in block**

No separate tax treatment is required. Loss shall be contained in WDV & depre will be allowed over the number of period

The block shall become NIL & Sec 50C shall not be attracted. Hence, it is a dead loss.

**CIT v. Rajiv Shukla (Delhi)** - The assessee can claim exemption u/s 54F, if the assets are held for more than 36 months even though in case of depreciable asset the gain is Short term.

**No other assets in the block**

> Additional depreciation would be allowed to an assessee only if he exercises the option of shifting out of the default tax regime provided u/s 115BAC(1A). It is not allowable when the assessee pays concessional rates of tax under the default tax regime u/s 115BAC [FA 2023].

## Sec 32(i)(ii) Additional Depreciation

<b>Assessee</b>	Any Assessee engaged in Manufacturing/Power Generating, Distribution, Transmission Unit. CBDT Cir 15/2016: printing & publication unit are also eligible for AD	
<b>Eligible Asset</b>	Acquire New P&M	<b>Benefit not available for Assessee opting for Sec 115BAC</b>
<b>Time</b>	After 31/03/2005	
<b>P&amp;M Does Not Include</b>	1) Second Hand P&M 2) P&M installed in Office / Guest House 3) Office appliance and Road Transport Agency, ship, aircraft. 4) The Whole Cost of which is allowed as Deduction 5) Ship or aircraft	
<b>Rate of AD</b>	<b>Used for more than 180 days</b> <b>Less than 180 days</b>	<b>20% of actual Cost</b> 10% of actual Cost. However the balance 10% shall be available in the subsequent year
<b>Romancing Analysis</b>	1. AD is allowed only in the year in which such P&M is first put to use. 2. AD shall be allowed even if block has nil/negative value. 3. AD shall be subtracted while computing closing WDV of the respective block. 4. AD is not available if new plant/machinery is sold in the year of acquisition. 5. AD is not available if power unit is claiming depreciation under SLM i.e. u/s 32(1)(i). 6. AD of 35% is not available for P&M used in generation or distribution of power. However, 20% shall be allowed for notified backward area.	

## Sec 32(2) Set Off & Carry Forward of Depreciation

<b>Current year Depreciation</b>	1. Against the profits of any business carried on during that year. 2. The balance, if any, against income under any other head.
<b>Unabsorbed Depreciation</b>	The unabsorbed depreciation can be carried forward for any no. of AYs & set off against income under any other head except salary & winning from lotteries, cross word puzzles etc.
<b>Other Conditions</b>	> Unabsorbed depreciation can be carry forward even return of income has not been filed. > The business / profession for which depreciation was originally computed need not be carried on in the year of set off. <b>For set-off purpose following order should be followed :</b> a. Current year depreciation. b. Brought forward business loss c. Unabsorbed depreciation.

In a case where the assessee is paying tax under default tax regime u/s 115BAC and there is a depreciation allowance in respect of a block of asset from an earlier AY attributable to additional depreciation u/s 32(1)(iii), which has not been given full effect to prior to AY 2024-25 and which is not allowed to be set-off in the AY 2024-25, corresponding adjustment shall be made to the WDV of such block of assets as on 1.4.2023 in the prescribed manner i.e., the WDV as on 1.4.2023 will be increased by the unabsorbed additional depreciation not allowed to be set-off [FA 2023]

## Format To Solve Depreciation Problem

Particulars of Assets	WDV as on 1/4	Addition made	Sale	Net value of block	Depreciation for the year	WDV on 31/3
-----------------------	---------------	---------------	------	--------------------	---------------------------	-------------

## Sec 32(1)(i) Depreciation In Case of Power Generation Unit

1. An assessee engaged in the business of generation or generation and distribution of power can claim Depreciation on SLM Basis or WDV Basis

2. Such option has to be Exercised before filling ROI for the 1st year in which it started Generation. Such option once exercised shall be final, if option is not opted then Depreciation shall be allowed on SLM basis only.

### Notes :

Where any asset is put to use for less than 180 days, the depreciation shall be restricted to 50% of the amount Calculated at the prescribed percentage.

## Sale of Assets by Power Generating Unit

1. If Charged Depreciation on WDV basis:  
Treatment shall be as per Sec 50.

2. If charged depreciation on SLM Basis.

### A) Where Loss arise (Terminal Depreciation)

Sale Value is Less then WDV	
OP WDV	xxx
(-) Money Received Including Scrap Value	(xxx)
<b>Terminal Depreciation to be claimed in Year</b>	<b>xxx</b>

### B) Where Profit arise

Sale Value is More then WDV	
OP WDV	xxx
(-) Money Received Including Scrap Value	(xxx)
> Amount upto Dep already claimed is taxable as Balancing charge [Sec 41(2)]	
> Balance surplus is Taxable as CG depends upon POHA [Sec 50A]	



## Sec 35 Expenditure On Scientific Research

In house research : Research should be related to the business	Contribution to outsiders Research may or may not be related to the business
Revenue Expenditure - 100% ALLOWED	National Laboratory / IIT's - 100% Sec 35(2AA)
Capital expenditure however capital expenditure does not include cost of Land.	Approved University, Colleges, Institution [Sec 35(1)(ii)] - 100%
Further no Depreciation shall be allowed on such assets - 100% ALLOWED	Social statistical research [Sec 35(1)(iii)] - 100%
Current year expense -- allowed Previous year expense- allowed. PY means 3 years before the commencement of business.	Company having main object as research [Sec 35(1)(ia)] - 100%
<b>Allowed in Default scheme as well</b>	<b>If opted for 115BAC than is benefit is not available</b>

### Other Points :

- 1) Deduction shall not be denied even if approval is withdrawn
- 2) No depreciation of the assets on which deduction is claimed
- 3) Unabsorbed expenditure shall be set off & c/f same as unabsorbed depreciation
- 4) W.r.e.f. 21-22 The deduction claimed by the donor with respect to donation given to any Research Association shall be disallowed unless such Research Association files the statement of Donation.

## Sec 234G Fees for Default in Filing Statement

1. Where the Association, university, college or other Institution notified u/s 35 fails to deliver or cause to deliver a statement or Furnish a certificate in prescribed form or manner or
2. It shall be Liable to pay a fees Rs.200 for every day during which failure continues. The amount of fees referred above shall not exceed the amount of which failure has occurred.

PGBP  
8.9

CA CS VIJAY SARDA  +91 8956651954

## Sec 271K Penalty for failure to furnish statements

The AO may direct that sum not less than 10000 but may extend to 100000 shall be paid by way of penalty by -

1. Where the Association, university, college or other Institution notified u/s 35 fails to deliver or cause to deliver a statement or Furnish a certificate in prescribe form or manner or
2. The Institution of fund fails to deliver or cause to deliver a statement or certificate referred u/s 80G.

## Sale of Scientific Research Assets

### Sold without being used

#### for other Purpose Sec 41(3):

#### Deemed PGBP : Lower of:

1. Net sale price of the asset or
  2. Deduction claimed u/s 35.
1. This shall apply even if business is not in existence in that PY
  2. **Artex Manufacturing co [SC]**: Capital Gain would arise only if sale price exceed the cost of acquisition of such assets

### Sold after being used for

#### other Business:

1. Actual cost of such asset shall be included in block of asset (i.e NIL because deduction is already allowed u/s 35).
2. If this asset is later on sold then provisions of sec 50 shall apply.

### Notes:

1. Unabsorbed capital expenditure on scientific research shall be treated same as unabsorbed depreciation.
2. If deduction under section 35 is claimed then depreciation u/s 32 is not allowed as deduction.

## Sec 35(2AA) Donation to national laboratory /IIT

100% Deduction allowed for any sum paid to a National Laboratory or a University or an Indian Institute of Technology or a specified person with a specific direction that the said sum shall be used for scientific research approved in this behalf by the prescribed authority. Deduction shall not be withdrawn even after approval is withdrawn.

[www.ekatvamacademy.com/www.vlearnclasses.com](http://www.ekatvamacademy.com/www.vlearnclasses.com)

## Sec 35(2AB) Assessee engaged in Manufacturing/biotechnology

**ASSESSEE** : Assessee engaged in manufacture or biotechnology  
**CONDITION** : Incur inhouse expenditure

**DEDUCTION** : 100% of Actual cost of new assets

# The deduction of this section is not available is assessee opted 115BAA/BAB.

## Sec 35CCC

## Sec 35CCD

Any Assessee incur any expense on agriculture extension project as notified by board	Any company incur expense on skill development project notified by Board
<b>Deduction = 100%</b> Exp on land or building are not allowed	<b>Deduction = 100%</b> of actual expenses on land or building are not allowed

# The deduction of this sec is not available is assessee opted 115BAA/BAB

## Sec 35CCA Expense for Rural Development Programmes

**Assessee contribute for :**

- National Fund for Rural Development;
- National Urban poverty Eradication Fund

The assessee shall be allowed a deduction of the amount of such expenditure incurred during the PY.

**DEDUCTION ALLOWED** : 100%

## Sec 35D Preliminary Expense

Allowed:- Only allowed to Resident

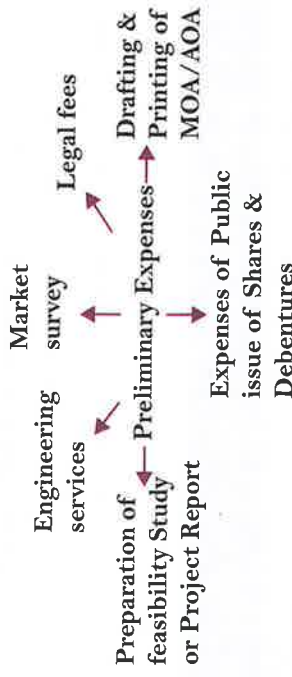

**Amount of Deduction: Lower of 1/5 th of lower of actual or Maximum**

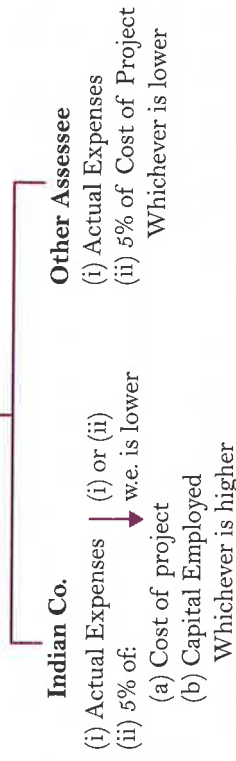

> This deduction is allowed in 5 equal installments.

> Cost of project: Amount invested in the Fixed Asset for new project.

> Capital Employed Shares + Debentures + long term borrowings for new project (Reserves & Surplus not included)

> Provided that the assessee shall furnish a statement containing the particulars of expenditure specified in this clause within such period, to such ITA in such form as may prescribed. [FA 2023]

# The preliminary expenditure is not allowed if assessee opted for default tax scheme [115BAC/BAD/BAE/BAB/BAA]

## Sec 35DD Amalgamation and Demerger expenses

Assessee an Indian company can take the deduction on 1/5th basics over 5 years starting from year of expenses.

# The deduction of this section is not available is assessee opted 115BAA/BAB.



## Sec 35DDA Expenditure related to VRS

Any Assessee incurring the expenditure on VRS deduction on 1/5th basics over 5 years starting from year of expenses.

# The Deduction of this section is not allowed if assessee opted alternative tax scheme

## Sec 35AD Deduction of certain specified business

Specified Business	Commence	Deduction
Laying and operating a cross-country natural gas/crude /petroleum pipeline	1.4.2009	100%
Setting up and operating a cold chain facility	1.4.2009	100%
Setting up & operating a warehousing facility for storage of agriculture produce	1.4.2009	100%
The business of building and operating a new hotel of 2 star or above category, anywhere in India.	1.4.2010	100%
The business of building & operating of a new hospital anywhere in India with at least 100 beds for patients.	1.4.2010	100%
A housing project under a scheme for slum redevelopment or rehabilitation .	1.4.2011	100%
Developing and building a housing project under a scheme for affordable housing .	1.4.2011	100%
Capital expense for a new plant or newly installed capacity in any existing plant for production of fertilizers	1.4.2012	100%
Setting up & operating an Inland Container depot or container freight Station notified or approved under Custom Act	1.4.2012	100%
Bee-keeping & production-Honey & Beewax	1.4.2012	100%
Setting up & operating warehouse facility for Storage of Sugar.	1.4.2012	100%
Laying & operating a slurry pipeline for the transportation of iron ore.	1.4.2014	100%
Setting up & operating Semi-conductor wafer fabrication manufacturing unit notified by CBDT	1.4.2014	100%
Developing or maintaining & operating/developing, maintaining & operating new infrastructure facility	1.4.2017	100%

### Deduction: If Section is opted

- 100% deduction of capital expenditure incurred during the PY
- 100% of capital expenditure incurred prior to commencement
- Capital expense not include land, goodwill & financial instrument.

### Conditions:

- Business should be new business i.e. should not be formed by splitting/ reconstruction of old business.
- Business should not be set up by transfer of old plant and machinery Old plant & machinery should not be more than 20% of total plant and machinery used for the business
- Deduction under Chapter VI- A shall not be allowed in respect of such business for any assessment year
- Actual cost of the asset for which deduction has been allowed under Sec 35 AD shall be taken as NIL
- Further, receipts on account of sale of those assets be taxable under head PGBP only, whatever the amount may be

**Note :** In case of an individual/HUF/AOP/BOI carrying on specified business, deduction u/s 35AD would be available only if they exercise the option of shifting out of the default tax regime provided u/s 115BAC(1A). If such assessee is paying concessional rates of tax under the default tax regime u/s 115BAC, deduction u/s 35AD would not be available. A company would not be eligible for deduction u/s 35AD, if it opts for the special provisions of sec 115BAA/115BAB [FA 2023]

## Sec 43B Deduction allowed on Actual Payment basis

Following Expenses are allowed only if following payments are made before filing ROI :

- Any tax, duty, cess / fee, by whatever name called, under any law. or
- Employers contribution to any provident fund or superannuation fund or gratuity fund or any other fund for the welfare of employees, or
- Any sum payable to employee as Bonus or Commission.
- Interest on any loan or borrowing from any public financial institution or a State financial corporation or a State industrial investment corporation, or
  - Interest on loan payable to a deposit taking NBFC or systemically important non-deposit taking NBFC in accordance with the terms and conditions of the agreement governing such loan or borrowing, or
  - Interest payable on any loan or advances from a scheduled bank/co-operative bank other than a primary agricultural credit society or a primary co-operative agricultural and rural development bank in accordance with the terms and conditions of the agreement governing such loan or advances, or

- f. Any sum payable by the assessee as an employer in lieu of any leave at the credit of his employee, or  
 g. Any sum payable by the assessee to the Indian Railways for the use of railway assets,

**h. Any sum payable by the assessee to a micro or small enterprise beyond the time-limit specified in sec 15 of the Micro, Small and Medium Enterprises Development Act, 2006 would be allowed as deduction only in that previous year in which such sum is actually paid.** Section 15 of the Micro, Small and Medium Enterprises Development Act, 2006 mandates payment of goods or services to supplier, being a micro or small enterprises by the buyer on or before the date agreed upon between them in writing i.e., as per the written agreement, which cannot be more than 45 days from the day of acceptance or the day of deemed acceptance of any goods or services by a buyer from a supplier. If there is no such written agreement, the payment shall be made before the appointed day i.e., within 15 days. If the sum payable by the assessee to a micro or small enterprise is paid as per written agreement (maximum within 45 days) or within 15 days in case of no agreement, the deduction can be claimed on accrual basis if mercantile method of accounting is followed by the assessee. However, if the sum payable by the assessee to a micro or small enterprise is not paid as per written agreement or within 15 days in case of no agreement, the deduction would be allowed in the previous year in which it is actually paid. [FA 2023]

### Meaning of Micro and Small enterprise : [FA 2023]

S.No	Meaning
Manufacturing enterprises and enterprises rendering services	
i)	Micro enterprise
	Investment in plant and machinery or equipment ≤ ₹ 1 crore
	AND
	Turnover ≤ ₹ 5 crores
ii)	Small Enterprise
	Investment in Plant and Machinery or equipment ≤ ₹ 10 crore
	AND
	Turnover ≤ ₹ 50 crores

## Sec 36 Other deductions

### (1) Insurance Premium

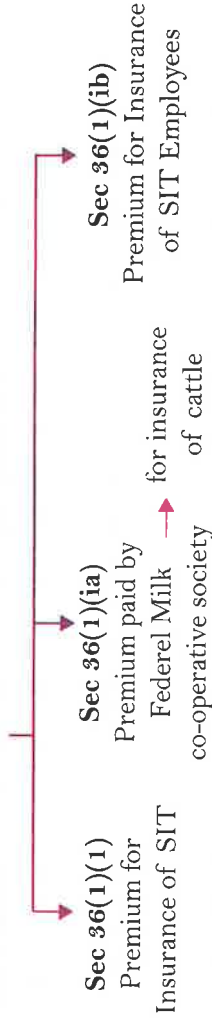

### (2) Employees Welfare Payment

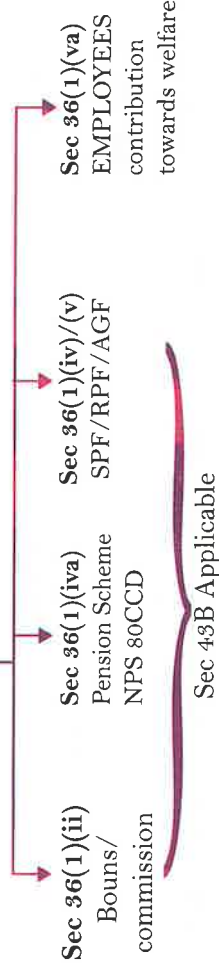

### (3) Sec 36(1)(ii)

- > Bonus or commission paid to Employees is allowed
- > It should not be paid as profit or dividend
- > It can be more than prescribed under POBA, 1965

### (4) Sec 36(1)(iva)

Employer Contribution towards National Pension Scheme u/s 80CCD is allowed as deduction upto:

- (i) Actual contribution
- (ii) 10% of salary (Basic + DA (Terms)] whichever is lower

### (5) Sec 36(1)(iv)/(v)

#### Deduction allowed for EMPLOYER'S Contribution in

- Statutory Provident Fund (SPF)
- Recognized Provident Fund (RPF)
- Approved Gratuity Fund (AGF)
- Any Provident Fund

**Note:** Deduction under any unrecognized or unapproved Fund not allowed





### (6) Sec 36(1)(va)

#### EMPLOYEES Contribution towards welfare Fund

- > Any amount received by fund, superannuation fund etc. is allowed only if it is paid to the Govt. before due date of the respective Act. Clarified by F.A.21
- > If paid after due date of the respective act, it will not be allowed as deduction & will be included in Income.

**Eg:** The due date of PF Act is 15th of Next month of the month in which PF is received Employees PF contri. for the month of July should be paid by the Employer to the govt/govt A/c till 15th August.

**Note:** If deposited before 15th August - **Allowed**

If not deposited before 15th August - **Added to Income.**

### (7) Sec 36(1)(vi)

- > Animals Used in Business other than Stock in Trade
- > Deduction under this section will be allowed in the year in which animals become permanently useless or die.
- > Amount of Deduction Cost of Animal - Sale value.

### (8) Sec 36(1)(vii) BAD DEBTS

Actual Bad Debts.      Provision for Bad Debts

↓  
Allowed

↓  
Not Allowed

But Allowed to Banks u/s 36(1)(viii)

- > **Actual Bad Debts**
  - Related to Business-Allowed
  - Related to Loan- Not allowed.
- > Except: Lending Business  
In Lending Business, Bad Debt Related to loan is allowed.

#### Notes:

- > Bad Debts must be written off in BOA in the year in which it is decided. There is no need to prove it.
- > Provision for Bad Debts is only allowed to Banks u/s 36(1)(viii).

### (9) Sec 36(1)(viii) Provision for Bad Debts

- > Deduction is allowed for provision for Bad Debts.
- > No Deduction is allowed for actual Bad debts u/s 36(1)(vii) for this provision amount, as it is debited in Provision Account

But IF

Actual Bad Debts > Provision for Bad Debts  
Actual Bad Debts - Provision = Difference

Will be allowed as deduction  
u/s 36(1)(vii)

- > Only one account will be made in Provision for Bad Debts of Rural & Non-Rural Branches.

### (10) Sec 36(1)(viii) Transfer to Special Reserve

Allowed to financial corporation engaged in providing long term finance(> 5 Years)

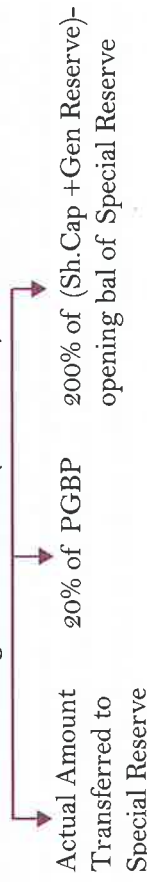

### (11) Sec 36(1)(ix) Expenses on promotion of Family Planning

Allowed to only companies : Amount of Deduction

Capital Allowed in 5 Equal Installments      Revenue Fully Allowed

PGBP  
8.13

CA CS VIJAY SARDA      +91 8956651954

www.ekatvacademy.com/www.vlearnclasses.com

**(12) Sec 36(1)(xvii) Planning of Sugar Cane**

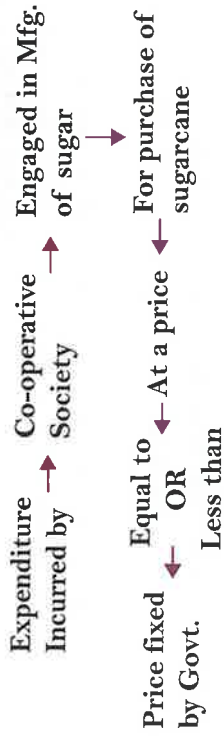

**(13) Sec 36(1)(xv) = STT**  
**Sec 36(1)(xvi) = CTT**  
 Allowed as deduction if Assessee has held shares, Securities & Commodities as Stock in Trade

**(14) Sec 36(1)(xviii) Marked to market loss/Expected loss**



**Sec 40(a)(i)/(ia) Payment made without TDS**

Any Payment made to NR on which TDS is deducted or deducted but not paid shall be disallowed = 100% Assessee will not be treated as assessee in default if the payee has submitted the ROI & has considered this as Income and Paid the tax due there on.	Any Payment made to R on which TDS is deducted or deducted but not paid shall be disallowed = 30% Assessee will not be treated as assessee in default if the payee has submitted the ROI & has considered this as Income and Paid the tax due there on.
--	--

**Sec 40(a)(ib) Equalization levy**

Not deducted then 100% disallowance will be attracted

**Sec 40(a)(iib) Fee/Charge paid by state Govt Undertaking**

**Any amount :-**

- a. Paid by way of royalty, licence fee, service fee, privilege fee, service charge/ any other fee/charge, by whatever name called, which is levied exclusively on; or
- b. Which is appropriated, directly or indirectly, from, a State Government undertaking by the State Government

**Sec 40(b) Payment To Partners**

a) Partner generate following Income from the firm & these income are taxable in the head PGBP to Partner.

S.No	Income	Taxability
1	Share of firm/LLP	Exempt u/s 10(2A)
2	Remuneration/salary	Subject to limit of
3	Interest on capital/Advance	Sec.40(b)
4	Commission	

- b) Any other income of partner apart from firm shall be taxable in his individual capacity in respective head for eg: interest on saving bank account taxable in IFOS
- c) Partner can take deduction of such expense which is incurred for earning the income

**Remuneration**

**Condition for remuneration:-**

- Remuneration should be paid only to a working partner
- Remuneration must be authorised by the partnership deed
- Remuneration should not pertain to period prior to partnership deed
- Remuneration should not exceed the permissible limit



## Maximum Permissible Limits :-

In case of any partnership firm

Book Profit	Limit
On the First ₹ 3,00,000 of the Book Profit or in case of a loss	₹ 1,50,000 or at the rate of 90 % of Book Profits, whichever is higher
On the balance of book profits	At the rate of 60 % of book profits

**Note :** While making adjustment in Step 2 above, following to be noted:

### a) Book Profit =

Income from PGBP as per Normal Provision after making all adjustment u/s 28-44[(-) Current year (+) b/f depreciation.]	
<b>Add:</b> Interest/remuneration paid or payable to partners [if debited]	XXX
<b>Less:</b> Interest allowable u/s 40(b)	xxx
<b>Book profit</b>	[xxx]

- b) Income chargeable under 'HP', 'CG' & 'IFOS' will not form part of 'Book Profits'.
- c) Remuneration include commission for the purpose of Sec 40[b]
- d) B/f business loss will not be deducted from profits.
- e) Permissible deductions from gross total income shall be ignored.
- f) As per ACIT vs great city manufacturing co it was held that once sec. 40(b) is allied sec.40(A)(2) cannot be applied.
- g) Any payment made beyond limit be disallowed while computing PGBP of firm

**Expl 1 to 40(b)** - If Individual is a partner in a firm, on representative capacity & receiving interest on individual capacity, then Sec 40(b) is not applicable. (which means interest beyond 12% is also allowed)

**Expl 2 to 40(b)** - If Individual is a partner in a firm, on individual capacity & receiving interest on representative capacity, then Sec 40(b) is not applicable. (which means interest beyond 12% is also allowed)

The above explanations are only for interest & not remuneration. Remuneration shall be limited to the limits of Sec 40(b)

## Interest

### Condition for claiming interest:-

- Payment of interest should be authorised by Partnership deed
- Payment of Interest should pertain to the period after the Partnership deed
- Rate of interest should not exceed 12% pa simple interest Interest paid to working as well as sleeping are both allowed Act does not make difference between capital/loan. Interest on both is 12%. (Capital covers both fixed & circulating)
- If firm pays interest to partner & partner pays interest to firm on drawing, it shall not be net off.

### Deduction is lower of:

- 12% of capital
- Actual Interest
- Amount given in deed

## Sec 41 Deemed PGBP

**Sec 41(1)** : If Assessee was allowed deduction in earlier PY by way of expense, loss, trading liability & now during the current PY. Assessee has obtained a refund of such liability or there is remission/cessation of such trading liability, then such refund/remission shall be taxable under PGBP. Eg : a) Sales tax refund

**Sec 41(2)** : Balancing Charge : Already discussed with power units depreciation.

**Sec 41(3)** : Sale of Scientific Research Assets as discussed in Scientific research.

**Sec 41(4)** : Recovery of bad debts - taxable in the year of recovery

## Sec 44AA Maintenance of Books of Accounts

### Business:

- Individual & HUF : Income exceeds 2,50,000  
Turnover exceeds 25,00,000
- Showed Lower Income
- Other than Individual/HUF : Income exceeds 1,20,000  
Turnover exceeds 10,00,000 in any 3 PYs

### Profession:

If Gross receipts in all 3 PYs exceed 1,50,000 Specified Profession includes legal, medical, engineering or architectural profession or the profession of accountancy or technical consultancy or interior decoration or any other profession.

### Note:

- Books are maintained for 6 years from end of relevant AY.
- Penalty for non compliance = 25000 [Sec 271A]

## Sec 2(12A) Books or Books of Account

“Books or books of account” include ledgers, day-books, cash books, account-books and other books, whether kept in the written form or in electronic form or in digital form or as printouts of data stored in such electronic form or in digital form or in a floppy, disc, tape or any other form of electro-magnetic data storage device.

## Sec 145 Method of Accounting

For income under PGBP and IOS the computation shall be as per cash or accrual system of accounting. The assessee is required to follow income computation and disclosure standards as may be notified by the CG. If the accounts of the assessee are correct and complete, but the method of accounting is such (in the opinion of the AO) the correct profits cannot be derived there from then the AO may make the assessment u/s 144.

British Paints India Ltd v CIT (SC)



CA CS VIJAY SARDA +91 8956651954

PGBP  
8.16

## Sec 44AB Audit of Accounts

### BUSINESS:

If Turnover Exceed Rs.1Cr.

No Tax Audit till Turnover do not exceed 10 cr if:

- Cash receipt does not exceed 5% of Total receipt &
- Cash payment does not Exceed 5% of Total payment

### PROFESSION:

If Gross Receipt Exceed Rs.50Lakhs.

### Other cases:

- If assessee declare lower income as specified in sec 44AE/44BB/44BBB. (Do Tax Audit).
- If Assessee declare lower income as specified in sec 44AD/44ADA and Income Exceed B.E.L (Do Tax Audit)
- Assessee not complied 5 years condition specified in 44AD has not been complied with adn Income exceed B.E.L. (Do Tax Audit)

### # No Tax Audit in Following cases:

- In case of 44AD if turnover do not exceed 2 crore
- In case of 44AD if turnover do not exceed 3 crore provided that cash receipt do not exceed 5% of Total turnover
- In case of 44AD if gross receipt do not exceed 50 lakhs
- In case of 44ADA if gross receipt do not exceed 75 lakhs provided that cash receipt do not exceed 5% of Total gross receipt.

### NOTE:

- Penalty for non compliance = 150000 or 0.5% of sales, whichever is lower [Sec 271B]
- Filling of report = Audit report of CA, 1 month before the due date of ROI

**Requirement of Tax Audit:** It is obligatory for the persons mentioned in column (2) of the table below, carrying on business or profession, to get his accounts audited before the “specified date” by a Chartered Accountant, if the conditions mentioned in the corresponding row of column(3) are satisfied [FA 2023]



## Sec 43CA Special provision for full value of consideration for transfer of assets other than capital assets in certain cases

- # If SDV exceed 110% of consideration SDV=FVOC
- # All other provisions of sec 50C applies
- # Sec applies when Land & Building held as SIT.

## Sec 44AD Presumptive Taxation

1. Individual, HUF, Firm (Not LLP)
2. Gross receipt/Turnover does not exceed 2cr.
3. **Not engaged in following** : Agency, Profession, Commission, GTA activity.  
Any business, other than business referred to in sec 44AE, whose total T/o or gross receipts in the P.Y.  $\leq$  ₹300 lakhs in the relevant P.Y., if aggregate cash receipts in the relevant PY  $\leq$  5% of total turnover or gross receipts.
4. **Presumptive Income: Higher of Income Declared or Deemed Income**  
Deemed Income:- 6% of Turnover or Gross receipt if payment is in prescribed mode (RULE 6 ABBA) during the P.Y. or before due date of filing of return u/s 139(1) in respect of that P.Y. (or) such higher sum claimed to have been earned by the assessee. [FA 2023] or 8% of Turnover.

5. Advance Tax is applicable
6. All deductions u/s 30-37(1)
7. 80C - 80U to be allowed
8. Set off losses allowed
9. Remuneration to partner u/s 40b not allowed.
10. Continuously opt for the scheme for the 5 years else this option is not available for next 5 years
11. Lower profit can be declared - yes [Maintain Accounts & Do Audit].

### Note:

For this purpose, the receipt of amount or aggregate of amounts by a cheque drawn on a bank or by a bank draft, which is not account payee, would be deemed to be the receipt in cash. [FA 2023]

## Sec 44AE Presumptive Taxation For GTA

**ASSEESSE** : Any Assessee engaged in plying, hiring, leasing the goods carriage **VEHICLE** : Should not own more than 10 vehicles at any time during the PY.

**PRESUMPTIVE INCOME** : Higher of declared or specified below

Heavy goods vehicle (Gross wgt > 12tone)	1,000 X per tonne X per month or part thereof X per vehicle
Other Vehicle	7,500 per month per vehicle (or for part thereof) during the period for which asset is owned

### OTHER CONDITION :

- 1) Advance tax as per requirement of Sec 207
- 2) Deduction u/s 30 to 38 are deemed to be allowed. Hence, no further deduction
- 3) Partner's remuneration as per Sec 40(b) deductible
- 4) Deduction u/c VI-A allowed
- 5) Set off is allowed
- 6) **If gross weight is not available, consider unladen weight:**  
It means weight of vehicle including all equipments ordinarily used with vehicle but excludes weight of driver, attendant and where alternative body or parts are used, the unladen weight of vehicle means weight of vehicle with heaviest such alternative body or part.
- 7) Assessee can declare a lower profit provided accounts are maintained & audit is done

## Sec 145B Taxability of Certain Income

Interest received by assessee on any compensation/enhanced compensation, shall be deemed to be income of PY in which it is received (Refer IFOS). Any claim for escalation of price in a contract/export incentives shall be deemed to be the income of PY in which reasonable certainty of its realisation is achieved. Assistance in the form of subsidy/grant/cash incentive/duty drawback/ waiver/concession be deemed to be the income of the PY in which it is received (refer PGBP)

PGBP  
8.17

CA CS VIJAY SARDA  +91 8956651954

[www.ekatvamacademy.com/www.vlearnclasses.com](http://www.ekatvamacademy.com/www.vlearnclasses.com)

## Sec 44ADA Presumptive Taxation For Professional

**ASSEESSE :** Resident Assessee being individual or firm(not LLP)

**TURNOVER:** Gross receipts should not exceed 50 lakhs.

**PRESUMPTIVE INCOME :** Higher of - Actual declared OR

- 50% of gross receipts

Assessee can declare presumptive income upto Rs. 75 Lakh in this section where the amount or aggregate of the amounts received during PY, in cash, does not exceed 5% of the total gross receipts. Further Payment received through bearer cheque is also considered as cash. [FA 2023]

### OTHER CONDITION :

- 1) Advance tax is mandatory by 15th of March
- 2) Deduction u/s 30 to 38 are deemed to be allowed. Hence, no further deduction
- 3) Partner's remuneration as per Sec 40(b) not deductible
- 4) If declares a lower income & NTI > BEL then books of accounts & audit is mandatory
- 5) Deduction u/c VI-A allowed
- 6) Set off is allowed
- 7) Assessee can declare a lower profit provided accounts are maintained & audit is done

## Sec 43(5) Speculative Transaction

"Speculative transaction" means a transaction in which a contract for purchase or sale of any commodity, including stocks & shares, is periodically or ultimately settled otherwise than by the actual delivery or transfer of the commodity or scrips.

However, following transactions shall not deemed to be speculative -

- a) Forward contracts
  - b) Trading & derivative through recognised stock exchange
  - c) Hedging contract in respect of raw material or merchandise or stock in shares
  - d) Eligible transaction in commodity derivative through Recognised Stock Exchange
- Speculative is considered as a Seperate business.

## Unsolved Questions

### P.1 Based on Depreciation

Mr. Venus, engaged in manufacture of pesticides, furnishes the following particulars relating to its manufacturing unit at Chennai, for the year ending 31-3-2024 :

Particulars	(₹ in lakhs)
WDV of Plant and Machinery on 31.3.2023	30.00
Depreciation including additional depreciation for P.Y. 2022-23	4.75
New machinery purchased on 1-9-2023	10.00
New machinery purchased on 1-12-2023	8.00
Computer purchased on 3-1-2024	4.00

### Additional information:

- All assets were purchased by A/c payee cheque.
- All assets were put to use immediately.
- New machinery purchased on 1-12-2023 and computer have been installed in the office.
- During the year ended 31-3-2023, a new machinery had been purchased on 31-10-2022, for ₹10 lakhs. Additional depreciation, besides normal depreciation, had been claimed thereon.
- Depreciation rate for machinery may be taken as 15%.
- The assessee has no brought forward business loss or unabsorbed depreciation as on 1.4.2023.

Compute the depreciation available to the assessee as per the provisions of the Income-tax Act, 1961 and the WDV of different blocks of assets as on 31-3-2024 if -

- (i) He exercises the option of shifting out of the default tax regime provided under section 115BAC(1A)
- (ii) He pays tax under the default tax regime under section 115BAC.



### P.2 Based on Depreciation

Gopichand carrying on proprietor business converted the same into Limited co. Gopi Pvt Ltd , furnishes you the following information:

**Block I** | WDV of Plant and machinery [Dep @15%] | 12,00,000  
**Block II** | WDV of Buildings[Dep @10%] | 25,00,000

The company Gopi Pvt Ltd acquired P&M in Dec 2023 for ₹10L It has been doing Business from 01.07.2023. Compute depreciation allowed to both for the AY 24-25.

### P.3 Based on Depreciation

Honest Industry furnishes you following details pertaining to the FY 23-24

Description	P&M	Building	Patents
Rate of Depreciation	15%	10%	25%
Opening balance as on 01-04-2023	14.5L	25L	15L
Acquired before 30-09-2023	12L	-	5L
Acquired after 01-12-2023	4L	18L	-
Transferred in March 2024, one of the patents held for the past 2 years	-	-	3L

A machinery acquired in July 2023 original cost ₹ 1.5L was destroyed by fire & the assessee received compensation of ₹0.5L from insurance co. Newly acquired building given above includes value of land of ₹3L. Calculate depreciation claim for AY 24-25.

Note: Ignore additional depreciation.

### P.4 Based on Deduction u/s 35

Ms. Vaishnavi, furnishes the following particulars for the P.Y. 2023-24. Compute the deduction allowable u/s 35 for

A.Y. 2024-25, while computing his income under the head "Profits and gains of business or profession", if:

- He is paying tax under default tax regime under section 115BAC
- He has exercised the option of shifting out of the default tax regime provided u/s 115BAC(1A)

Particulars	₹
Amount paid to notified approved Indian Institute of Science, Bangalore, for Scientific research	1,00,000
Amount paid to IIT, Delhi for an approved scientific research programme	2,50,000
Amount paid to X Ltd., a company registered in India which has as its main object Scientific research and development, as is approved by the prescribed authority	4,00,000
Expenditure incurred on in-house scientific research and development facility as approved by the prescribed authority related to his business :	
(a) Revenue expenditure on scientific research	3,00,000
(b) Capital expenditure (including cost of acquisition of land 5,00,000) on scientific research	7,50,000

### P.5 Based on Specified Business u/s 35AD

Mr. A commenced operations of the businesses of setting up a warehousing facility for storage of food grains, sugar and edible oil on 1.4.2023. He incurred capital expenditure of ₹80 lakh, ₹60 lakh and ₹50 lakh, respectively, on purchase of land and building during the period January, 2023 to March, 2023 exclusively for the above businesses, and capitalized the same in its books of account as on 1st April, 2023. The cost of land included in the above figures is ₹50 lakh, ₹40 lakh and ₹30 lakh, respectively. During the P.Y. 2023-24, he incurred capital expenditure of ₹20 lakh, ₹15 lakh & ₹10 lakh, respectively, for extension/reconstruction of the building purchased and used exclusively for the above businesses. Compute the income and used exclusively for the above businesses. Compute the income under the head "Profits and gains of business or profession" for the A.Y. 2024-25 and the loss to be carried forward, assuming that Mr. A is exercising the option of shifting out of the default tax regime provided u/s 115BAC(1A) and has fulfilled all the conditions specified u/s 35AD and wants to claim deduction u/s 35AD and has not claimed any deduction under Chapter VI-A under the heading:

“C – Deductions in respect of certain incomes”. The profits from the business of setting up a warehousing facility for storage of food grains, sugar and edible oil (before claiming deduction under section 35AD and sec 32) for the A.Y. 2024-25 is ₹16 lakhs, ₹14 lakhs and ₹31 lakhs, respectively. Also, assume in respect of expenditure incurred, the payments are made by account payee cheque or use of ECS through bank account.

### P.6 Based on Deduction

Win Limited commenced business of operating a 3 star hotel in Tirupati on 1-4-2023. It furnishes you the following information

Particulars	₹(in L)
Cost of land (acquired in June 2022)	60
Cost of construction of hotel building	
FY 2022-23	30
FY 2023-24	150
P&M acquired during FY 2023-24	30
Net profit before depreciation for FY 2023-24	80

Determine amount eligible for deduction u/s 35AD for AY 2024-25

### P.7 Based on Specified Business u/s 35AD

MNP Ltd. commenced operations of a new 4-star hotel in Chennai on 1.4.2023. The co. incurred capital expense of ₹ 40L during the period January, 2023 to March, 2023 exclusively for the above business, & capitalized same in its books of account as on 1st April, 2023. Further, during the PY 2023-24, it incurred capital expense of ₹ 2.5 crore (out of which ₹ 1 crore was for acquisition of land) exclusively for the above business. Compute the income under the head “PGBP” for AY 24-25, assuming that MNP Ltd. has fulfilled all the conditions specified for claim of deduction u/s 35AD & has not claimed any deduction under Chapter VI-A under the heading “C. – Deductions in respect of certain incomes”.

The profits from the business of running this hotel (before claiming deducting u/s 35AD) for the A.Y. 24-25 is ₹ 80L. Assume that the co. also has another existing business of running a four-star hotel in Kanpur, which commenced operations 5 years back, the profits from which was ₹ 130L for AY 24-25. Would MNO Ltd. be entitled to deduction u/s 35AD if it transfers the operation of the hotel in Chennai to PQR Ltd, while continuing to own the said hotel?

### P.8 Based on Taxation and Deductions of PGBP

Ramji Ltd., engaged in manufacture of medicines (pharmaceuticals), furnishes the following information for the year ended 31.03.2024

- Municipal tax relating to office building ₹51,000 not paid till 30.09.2023.
- Patent acquired for ₹20L on 01.09.2023 & used from the same month.
- Capital expense on scientific research ₹10L which includes land ₹2L.
- Amount due from customer X, outstanding for more than 3 years, written off as bad debt in the books ₹5L.
- Income-tax paid ₹0.9L by co in respect of non-monetary perquisites provided to its employees.
- Provident fund contribution of employees ₹5.5 remitted in July 2024.
- Expense towards advertisement in souvenir of a political party ₹1.5L.
- Refund of sales tax ₹0.75L received during the year, which was claimed as expense in an earlier year.

State with reasons the taxability or deductibility of items given above under Income-tax Act.

**Note:** Computation of total income is not required.

### P.9 Based on Book Profit

Rao & Jain, a partnership firm consisting of two partners, reports a net profit of ₹7L before deduction of the following items:

- Salary of ₹20,000 pm payable to 2 working partners of the firm (as authorized by the deed of partnership).
- Depreciation on P&M u/s 32 (computed) ₹1.5L.
- Interest on capital at 15% pa (as per the deed of partnership).  
The amount of capital eligible for interest ₹5L.



**Compute:**

- (i) Book-profit of the firm u/s 40(b) of the Income-tax Act, 1961.  
 (ii) Allowable working partner salary for the A.Y. 24-25 as per section 40(b).

**P.10 Based on Presumptive Taxation u/s 44AD**

Mr. Praveen engaged in retail trade, reports a turnover of ₹2,98,50,000 for the financial year 2023-24. Amount received in cash during the P.Y. 2023-24 is ₹4,00,000 and balance through prescribed electronic modes on or before 31st October 2024. His income from the said business as per books of account is ₹15,00,000 computed as per the provisions of Chapter IV-D "Profits and gains from business or Profession" of the Income-tax Act, 1961. Retail trade is the only source of income for Mr. Praveen. A.Y. 2023-24 was the first year for which he declared his business income in accordance with the provisions of presumptive taxation u/s 44AD.

- (i) Is Mr. Praveen also eligible for presumptive determination of his income chargeable to tax for the assessment year 2024-25?  
 (ii) If so, determine his income from retail trade as per the applicable presumptive provision.  
 (iii) In case Mr. Praveen wants to declare profits as per books of account from retail trade, what are his obligations under the Income-tax Act, 1961?  
 (iv) What is the due date for filing his return of income under both the options?

**P.11 Based on Presumptive income u/s 44AE**

Mr. Sukhvinder is engaged in the business of plying goods carriages. On 1st April, 2023, he owns 10 trucks (out of which 6 are heavy goods vehicles, the gross vehicle weight of such goods vehicle is 15,000 kg each). On 2nd May, 2023, he sold one of the heavy goods vehicles and purchased a light goods vehicle on 6th May, 2023. This new vehicle could, however, be put to use only on 15th June, 2023. Compute the total income of Mr. Sukhvinder for the A.Y. 2024-25, taking note of the following data:

Freight charges collected		12,70,000
Less : Operational expenses	6,25,000	
Depreciation as per section 32	1,85,000	
Other office expenses	15,000	8,25,000
Net Profit		4,45,000
Other business & non-business income		70,000

**P.12 Computation of Gross Total Income**

Mr. Gupta is having a trading business & his Trading & Profit & Loss Account for the FY 23-24 is as under:

To Opening Stock	1,00,000	By Sales	70,00,000
To Purchase	49,00,000	By Closing Stock	50,000
To Gross Profit	20,50,000		
Total	70,50,000	Total	70,50,000
To Salary to employees (Including Contribution to PF)	5,00,000	By Gross Profit b/f	20,50,000
To Donation to PM Relief Fund	1,00,000		
To Provision for bad debts	50,000		
To Bonus(employeees)	50,000		
To bank loan Interest	50,000		
To Family planning exp incurred on EE	20,000		
To Depreciation	30,000		
To Income-tax	1,00,000		
To Net profit	11,50,000		
Total	20,50,000	Total	20,50,000

**Other information:**

- (a) Depreciation allowable ₹ 40,000 as per Income-tax Rules, 1962.  
 (b) No tax deducted at source on payment of interest on bank loan.  
 (c) Payment of bonus to workers made in Oct, 2024 on Diwali festival.  
 (d) Out of salary, ₹25,000 pertains to his contributions to RPF which was deposited after due date of filing ROI. Further, employees contribution of ₹25,000 was also deposited after due date of filing ROI. Calculate gross total income of Mr. Gupta for the A.Y. 24-25.

# Chapter 9

## CLUBBING OF INCOME

Sec	Particulars	Pg No
1	Basics of Clubbing Income	9.2
2	Sec 60 Transfer of Income without Transfer of Assets	9.2
3	Sec 61 Revocable Transfer of Assets	9.2
4	Sec 64[1A] Minor's Income	9.2
5	Sec 64(1)(iv) Transfer to Spouse for Inadequate or without consideration	9.3
6	Sec 64(1)(vi) Transfer to Son's Wife	9.3
7	Sec 64(1)(vii), (vii) Assets transferred to 3rd person for benefit of Wife/Son's Wife	9.3
8	Sec 64(1)(ii) Salary, Commission earned by Spouse	9.3
9	Business out of Gifted Money	9.4
10	Sec 64(2) Transfer of Asset to HUF	9.4
11	Cross Transfers	9.4
12	Unsolved Questions	9.5

“

**If you are not  
doing what you Love,  
you are  
wasting your time**

”





## Basics of Clubbing

- > Negative Income is also Clubbed.
- > Clubbing Provisions are mandatory.

### Sec 60 Transfer of Income Without Transfer of Assets

If any person transfer any Income without transfer of Assets then such income is taxable in the hands of transferor.

### Sec 61 Revocable Transfer of Assets

Income arising to any person by virtue of revocable transfer shall be included in total income of transferor. Revocable transfer of asset transfer shall be deemed to be revocable if it contains any provision for re-transfer of the whole or any part of the income or assets to the transferor, or it gives transferor a right to re-assume power over the whole or any part of income or assets. Provision of sec 61 shall not apply to transfer which is revocable after the life time of the beneficiary or transferee.

## Sec 64[1A] Minor's Income

All other income except specified shall be Taxable

Parent Marriage Substist →

Clubbed in the hands of parent having Greater Income

Parent Marriage Do not Substist →

Clubbed in the hands of parent Who maintain the Child

Following shall not be clubbed Taxable in the hands of minor himself.

1. Earned out of skill & Talent
2. Earned out of manual work done
3. Income earned by a minor  
Handicap covered u/s 80U.

1. Where any such income is once included in total income of either parent, any such income arising in any succeeding year shall not be included in total income of the other parent, unless AO is satisfied, after giving that parent an opportunity of being heard, that it is necessary so to do.
2. Once the Income of minor is clubbed then exemption of Rs.1500 per child shall be available [irrespective of no of child] [Sec 10(32)] not available if opted
3. Child includes step child: Child in relation to an individual, includes a step-child and an adopted child.
4. Minor child includes minor married daughter: Provision of sec 64(1A) shall apply in case of minor married daughter also
5. No clubbing after attaining majority: Where the minor child become major during the previous year, provision of this section will apply till such date
6. If tax is paid as per 115BAC then exemption u/s 10(32) Rs 1500 not available

Club  
9.2





## Business out of Gifted Money

A. Profit earned in the business shall be clubbed in the following manner

$$\text{Profit X} \frac{\text{Gifted Amount}}{\text{Total Capital Employed}}$$

### Sec 64(2) Transfer of Asset to HUF

If any Individual transfers any asset to his HUF without/for inadequate consideration then Income from such asset is received by HUF but taxable in the hands of the Transferor (Member). After Partition of HUF, Income from such asset received, by spouse shall be clubbed in hands of Transferor

**Note :**

- Income includes loss
- Where an asset transferred is converted into other form, income derived from such converted asset shall be clubbed
- Natural love & affection is not adequate consideration for Sec 64
- If asset transferred is sold by transferee then CG is income & clubbed
- If there are 2 transactions both interconnected & part of same transaction, shall be considered evasion of tax & therefore clubbed

## Cross Transfers

In the case of cross transfers also (e.g., A making gift of ₹50,000 to the wife of his brother B for the purchase of a house by her and a simultaneous gift by B to A's minor son of shares in a foreign company worth ₹50,000 owned by him), the income from the assets transferred would be assessed in the hands of the deemed transferor if the transfers are so intimately connected that they form part of a single transaction, and each transfer constitutes consideration for the other by being mutual or otherwise.

Thus, in the instant case, the transfers have been made by A and B to persons who are not their spouse or minor child so as to circumvent the provisions of this section, showing that such transfers constituted consideration for each other. The Supreme Court, in case of **CIT v.**

**Keshavji Morarji [1967]**, observed that if two transactions are inter-connected and are parts of the same transaction in such a way that it can be said that the circuitous method was adopted as a device to evade tax, the implication of clubbing provisions would be attracted. Accordingly, the income arising to Mrs. B from the house property should be included in the total income of B and the dividend from shares transferred to A's minor son would be taxable in the hands of A. This is because A and B are the indirect transferors to their minor child and spouse, respectively, of income-yielding assets, so as to reduce their burden of taxation.

## Unsolved Questions

### P.1. Concept of Business out of Gifted money

Mr. Vaibhav started a proprietary business on 01.04.2022 with a capital of ₹5,00,000. He incurred a loss of ₹ 2,00,000 during the year 2022-23.

To overcome the financial position, his wife Mrs. Vaishali, a software Engineer, gave a gift of ₹5,00,000 on 01.04.2023, which was

immediately invested in the business by Mr. Vaibhav. He earned a profit of ₹4,00,000 during the year 2023-24. Compute the amount to be clubbed in the hands of Mrs. Vaishali for the A.Y. 2024-25. If Mrs.

Vaishali gave the said amount as loan, what would be the amount to be clubbed?

### P.2 Based on Sec 64 (IA) Minors Income

Compute the gross total income of Mr. A & Mrs. A from the following information assuming both exercise the option of shifting out of the default tax regime provided under section 115BAC(1A)

Particulars	₹
Salary income (computed) of Mrs. A	2,30,000
Income from profession of Mr. A	3,90,000
Income of minor son B from company deposit	15,000
Income of minor daughter C from special talent	32,000
Interest from bank received by C on deposit made out of her special talent	3,000
Gift received by C on 30.09.2023 from friend of Mrs. A	2,500

Brief working is sufficient. Detailed computation under various heads of income is not required.

### P.3 Based on Clubbing of Minors Income

Mr. Chaval and his wife Mrs. Dal furnish the following information:

- Salary income (computed) of Mrs. Dal – ₹4,60,000
- Income of minor son 'B' who suffers from disability u/s 80U – ₹1,08,000
- Income of minor daughter 'C' from singing – ₹86,000
- Income from profession of Mr. Chaval – ₹7,50,000
- Cash gift received by 'C' on 2.10.2023 from friend of Mrs. Dal on winning of singing competition – ₹10,000
- Income of minor married daughter 'A' from company deposit ₹30,000 Compute total income of Mr. Chaval & Mrs. Dal for AY assuming both exercise the option of shifting out of the default tax regime provided under section 115BAC(1A)

### P.4 Concept of Clubbing of Minor Income

Mr. Pranav has an income from salary of ₹3,50,000 and his minor children's income are as under Minor daughter has earned the following income:

From a TV show – ₹50,000

From interest on FD with bank – ₹5,000 (by Mr. Pranav from his income)

Minor son has earned the following income:

From the sale of a own painting – ₹10,000

From interest on FD with bank – ₹1,000 (deposited by Mr. Pranav from his compute the gross total income of Mr. Pranav, assuming that they do not opt section 115BAC.



# Chapter 10

## SET OFF AND CARRY FORWARD

Sr No.	Particulars	Pg No
1	Sec 70 Intra Head Adjustment	10.2
2	Sec 71 Inter Head Adjustment	10.2
3	Sec 94(8) Bonus Stripping.	10.3
4	Explanation : Record Date	10.3
5	Explanation : Units	10.3
6	Summary Chart	10.4
7	Sec 73A C/f & Set off of losses by Specified Businesses	10.5
8	Exception to the rule that Assessee who has incurred the loss can only be set off, that loss	10.5
9	Order of Set off	10.5
10	Sec 80 Submission of return of losses	10.5
1.1	Unsolved Questions	10.6

“

5 by 5 RULE

If it is not going to matter in 5 years, don't spend more than 5 minutes being upset about it

”

### IMPORTANT AMENDMENTS/ NOTIFICATIONS/CIRCULARS

Sr No.	Particulars	Pg No
1	Sec 94(8) Bonus Stripping	10.3
2	Explanation : Record Date	10.3
3	Explanation : Units	10.3



Set  
10.1

CA CS VIJAY SARDA  +91 89566651954

[www.ekatvamacademy.com/](http://www.ekatvamacademy.com/) [www.vlearnclasses.com](http://www.vlearnclasses.com)

## Sec 70 Intra Head Adjustment

Particulars	Provisions	
<b>Salary</b>	There cannot be any loss in Head Salary	
<b>House Property</b>	Loss from House property can be setoff against income from house property	
<b>PGBP</b>	Normal Business	Normal Business loss can be setoff against any Business Income
	Speculative Business	Speculative loss can be setoff only against Speculative Income
	Specified Business	Specified Business loss can be setoff only against specified business Income
<b>Capital Gains</b>	LTCL	LTCL can be setoff only against LTCL
	STCL	STCL can be setoff against any capital gains
<b>Other Sources</b>	Normal Loss	IFOS loss can be setoff against IFOS Income
	Loss from O & M Horse race	Horse race loss can be setoff only against Horse Race Income
	Loss from an Exempt Source	Loss from an exempt source cant be setoff
	Source	<b>CIT Vs. Tyagrajan</b>

## Sec 71 Inter Head Adjustment

Particulars	Provisions	
<b>Salary</b>	Loss from any head can be setoff against salary except PGBP & Unabsorbed Depreciation	
<b>House Property</b>	The loss under the head "Income from house property" would not be allowable to be set-off against income under the other head if the assessee pays tax at concessional rate u/s 115BAC. However, if the assessee exercises the option of shifting out of the default tax regime provided u/s 115BAC(1A) and there is a loss under the head "Income from house property" and the assessee has income assessable under any other head of income, the maximum loss from house property which can be set-off against income from any other head is ₹ 2 lakhs. In other words, in such case, the amount of such loss exceeding ₹ 2 lakhs would not be allowable to be set-off against income under the other head. [FA 2023]	
<b>Capital Gains</b>	<b>Business</b>	Normal Business loss can be setoff against any Income except salary.
	<b>Speculative Business</b>	Speculative loss can be setoff only against Speculative Income
	<b>Specified Business</b>	Specified Business loss can be S/O only against specified business Income Sec 35AD
	<b>General Rule</b>	Loss from other head can be setoff against CG but loss from CG cant be setoff against other Head I.E.
<b>Other Sources</b>	LTCL	LTCL can be setoff only against LTCL
	STCL	STCL can be setoff against any capital gains
<b>Losses from Specified business u/s 35AD:</b>	<b>Normal Loss</b>	IFOS loss can be setoff against IFOS Income
	<b>Loss from O &amp; M Horse race</b>	Horse race loss can be setoff only against Horse Race Income
	<b>Loss from an Exempt Source</b>	Loss from an exempt source cant be setoff
	<b>Source</b>	<b>CIT Vs. Tyagrajan</b>

Set  
10.2



### Note:

Following brought forward losses/ depreciation is not allowed to be set off while computing total income under default tax regime u/s 115BAC :

1. Brought forward loss from self-occupied house property
2. Brought forward business loss of specified business u/s 35AD
3. Brought forward business loss on account of deduction u/s 35(1)(ii)/(iii)/(iiia)/(iii) or u/s 35(2AA)
4. Unabsorbed depreciation attributable to additional depreciation u/s 32(1)(iia). [FA 2023]

### **Following points should be noted in respect of sec 70 and 71:**

No order of priority is given in the Act. Act does not prescribe any order of priority for s/o of losses, therefore, one should try to set off of those losses which cannot be set off in future /having shorter period Once loss is C/f it can be setoff against same head of Income only.

## Sec 94(8) Bonus Stripping

### **Where;**

- (a) Any person buys or acquires any securities or units within a period of 3 months prior to the record date;
- (b) Such person is allotted additional securities or units without any payment on the basis of holding of such securities or units on such date;
- (c) Such person sells or transfers all or any of the securities or units referred to in clause (a) within a period of 9 months after such date, while continuing to hold all or any of the additional securities or units referred to in clause (b), then, the loss, if any, arising to him on account of such purchase and sale of all or any of such securities or units shall be ignored for the purposes of computing his income chargeable to tax.

## Explanation : Record Date

**"Record date"** means such date as may be fixed by —

- (i) A company;
- (ii) A Mutual Fund or the Administrator of the specified undertaking or the specified company referred to in the Explanation to clause (35) of section 10; or
- (iii) A business trust ; or
- (iv) An Alternative Investment Fund, made under SEBI Act. for the purposes of entitlement of the holder of the securities or units, as the case may be, to receive dividend, income, or additional securities or units without any consideration, as the case may be;

## Explanation : Units

**"Unit"** shall mean,

- (i) A unit of a business trust defined in clause (13A) of section 2;
- (ii) A unit defined in clause (b) of the Explanation to section 115AB; or
- (iii) Beneficial interest of an investor in an AIF and shall include shares or partnership interests.

## Summary Chart

Particulars	Set off	
	Intra head	Inter head
<b>House Property Loss</b>	<b>Yes</b>	<b>Yes</b>
<b>Business Loss</b>	<b>Yes</b>	<b>Yes, except Salary</b>
<b>Speculation Loss (Same day sale &amp; purchase i.e without taking delivery) Sec 43(5)</b>	<b>Yes</b>	<b>No</b>
<b>Loss under capital gain head</b>	<b>Yes; LT against LT only, ST against ST &amp; LT</b>	<b>No</b>
<b>Loss from activity of owning &amp; maintaining race horses</b>	<b>Yes</b>	<b>No</b>
<b>Loss from Lotteries</b>	<b>No</b>	<b>No</b>
<b>Other losses</b>	<b>Yes</b>	<b>Yes</b>

Business Loss	Yes	Yes, except Salary	Section 72
<b>Speculation Loss (Same day sale &amp; purchase i.e without taking delivery) Sec 43(5)</b>	<b>Yes</b>	<b>No</b>	<ul style="list-style-type: none"> <li>Set off with both business income &amp; speculation income.</li> <li>Carry forward for 8AY.</li> <li>Section 80 applicable. It means if return of loss is not filed or filed late business loss cannot be carried forward.</li> <li>Assessee who has incurred the loss can only set off that loss [6 exception]</li> <li>Even if business is discontinued business loss can be set off.</li> </ul>
<b>Loss under capital gain head</b>	<b>Yes; LT against LT only, ST against ST &amp; LT</b>	<b>No</b>	<ul style="list-style-type: none"> <li>Past year speculation loss can be set off only with speculation income.</li> <li>Carry forward for 4 AY.</li> <li>Sec 80 applicable. It means if return of loss is not filed or filed late speculation loss cannot be carried forward</li> <li>Assessee who has incurred the loss can only set off that loss [exception not applicable]</li> <li>Even if business is discontinued business loss can be set off.</li> </ul>
<b>Loss from activity of owning &amp; maintaining race horses</b>	<b>Yes</b>	<b>No</b>	<ul style="list-style-type: none"> <li>LT can be set off only with LT, ST can be set off with both LT &amp; ST.</li> <li>Carry forward for 8 AY.</li> <li>Section 80 applicable. It means if return of loss is not filed or filed late Capital gain (loss) cannot be carried forward.</li> </ul>
<b>Loss from Lotteries</b>	<b>No</b>	<b>No</b>	<ul style="list-style-type: none"> <li>Past year horse loss can be set off only with horse income.</li> <li>Carry forward for 4 AY.</li> <li>Section 80 applicable. It means if return of loss is not filed or filed late business loss cannot be carried forward.</li> <li>Assessee who has incurred the loss can only set off that loss [exception not applicable]</li> <li>Even if business is discontinued business loss can be set off.</li> </ul>
<b>Other losses</b>	<b>Yes</b>	<b>Yes</b>	



#### Notes :

#### Loss from lotteries :

No other loss can be set off against this income. Deduction u/s 57 not available. Deduction u/s 80C to 80U not available. Basic exemption not available. Flat rate 30%.

#### Other Losses :

In case of choice this loss should be set off first since it cannot be carried forward.

### Sec 73A Carry Forward & Set off of losses by Specified Businesses

1. An assessee exercising the option of shifting out of the default tax regime provided u/s 115BAC(1A) and carrying on specified business, can claim deduction u/s 35AD in respect of capital expenditure (other than land, goodwill and financial instruments) incurred in respect of such business, subject to fulfillment of specified conditions. Any loss computed in respect of the specified business referred to in sec 35AD can, however, be set off only against profits and gains, if any, of any other specified business. The unabsorbed loss, if any, will be carried forward for set off against profits and gains of any specified business in the following assessment year and so on. [FA 2023]
2. The unabsorbed loss can be carried forward indefinitely for set-off against income from specified business.
3. Filling of Loss Return shall be mandatory in order to c/f the loss.

### Exceptions to the Rule that Assessee who has Incurred the Loss can only be set off that Loss [Applicable to Sec 72 & 32(2)]

**Sec 72A** - Accumulated business loss of amalgamating company can be carried forward and set off by amalgamated company.

**Sec 72A** - Accumulated business loss of demerged company can be carried forward and set off by resulting company.

**Sec 72A** - Conversion of sole proprietorship concern into a company

**Sec 72A** - Conversion of firm into a company.

**Sec 72A** - Conversion of Pvt. limited Company to LLP or Unlisted Company to LLP. (Limited Liability Partnership).

**Sec 78(2)** - Losses of business acquired on inheritance. Father dies and son inherits the business then son can set off the business loss.

### Order of Set Off

Sec 72(2), where unabsorbed depreciation or unabsorbed exp of a capital nature on scientific research related to the business carried on by the assessee, are also C/f then, effect shall first be given to the unabsorbed business loss. Therefore **priority of set off is as under:**

1. Current year depreciation,
2. Current year expenditure on scientific research,
3. Current year allowable expenditure on promotion of family Planning
4. Brought forward business or profession loss,
5. Unabsorbed depreciation,
6. Unabsorbed capital expenditure on scientific research,
7. Unabsorbed expenditure on promotion of family planning.

### Sec 80 Submission of Return of Losses

As per section 80, the assessee **must have filed a return of loss u/s 139(3) in order to carry forward and set off of:**

- Business loss to be carried forward u/s 72(1)
- Speculation business loss to be carried forward u/s 73(2)
- Loss from specified business to carried forward u/s 73A(2)
- Loss under the head "Capital Gains" to be c/f u/s 74(1) &
- Loss incurred in the activity of owning and maintaining race horses to be carried forward u/s 74A(3).

## Unsolved Questions

### P1. Based on Computation of Gross Total Income

Compute the gross total income of Ms. Surbhi for the A.Y. 2024-25 from the information given below –

Particulars	₹
Income from house property (computed)	1,25,000
Income from business (before providing for depreciation)	1,35,000
Short term capital gains on sale of unlisted shares	56,000
Long term capital loss from sale of property (b/f from A.Y. 2023-24)	(90,000)
Income from tea business	1,20,000
Dividends from Indian companies carrying on agricultural operations (Gross)	80,000
Current year depreciation	26,000
Brought forward business loss (loss incurred six years ago)	(45,000)

### P2. Based on Computation of Gross Total Income

Ms. Vaishnavi submits the following details of his income for the A.Y. 2024-25

Particulars	₹
Income from salary (computed)	3,00,000
Loss from let out house property	(40,000)
Income from sugar business	50,000
Loss from iron ore business for P.Y. 2018-19 (Discontinued in P.Y. 2019-20)	(1,20,000)
Short term capital loss	(60,000)
Long term capital gain	40,000
Dividend	5,000
Income received from lottery winning (Gross)	50,000
Winnings from card games (Gross)	6,000
Agricultural income	20,000
Short-term capital loss u/s 111A	(10,000)
Bank interest on Fixed deposit	5,000

Calculate gross total income and losses to be carried forward, assuming that he has exercised the option of shifting out of the default tax regime provided under section 115BAC(1A).

### P3. Based on Sec 115BAC(1A).

Mr. A furnishes you the following information for the year ended 31.03.2024

Particulars	₹
(i) Income from plying of vehicles (computed as per books) (He owned 5 light goods vehicle throughout the year)	3,20,000
(ii) Income from retail trade of garments (Computed as per books) (Sales turnover rs. 1,35,70,000) Mr. A had declared income on presumptive basis u/s 44AD for the first time in A.Y. 2023-24. Assume 10% of the turnover during the previous year 2023-24 was received in cash and balance through A/c payee cheque and all the payments in respect of expenditure were also made through A/c payee cheque or debit card.	7,50,000
(iii) He has brought forward depreciation relating to A.Y. 2022-23	1,00,000

Compute taxable income of Mr. A and his tax liability for the assessment year 2024-25 with reasons for your computation, assuming that he exercises the option of shifting out of the default tax regime provided under section 115BAC(1A).

Set  
10.6

CA CS VIJAY SARDA  +91 8956651954

www.ekatvamacademy.com/www.vlearnclasses.com



# Chapter 11

## DEDUCTIONS

### IMPORTANT AMENDMENTS/ NOTIFICATIONS/CIRCULARS

Sr No	Particulars	Pg No
	Basics of Deductions	11.2
2	Sec 80TTA Deduction for Interest on Saving Account	11.2
3	Sec 80GGA Scientific research & rural development	11.2
4	Sec 80GGB Contribution to Political party by Indian Company	11.2
5	Sec 80GGC Contribution to Political parties	11.3
6	Sec 80TTB Interest on Deposits	11.3
7	Sec 80U Deduction for Person with Disability	11.3
8	Sec 80DD Maintenance of Disable Dependent	11.4
9	Sec 80DDB Treatment of Specified Diseases	11.4
10	Sec 80D Medical Treatment	11.4
11	Sec 80EEB Tax Incentive for Electric Vehicle	11.5
12	Sec 80EE Interest on Housing loan	11.5
13	Sec 80E Interest on Education Loan	11.5
14	Sec 80EEA Interest on Self Occupied Property	11.6
15	Sec 80C Deduction on Eligible Investment	11.6
16	Sec 80CCC LIC Pension Fund	11.7
17	Sec 80RRB Royalty on Patents	11.7
18	Sec 80CCD Contribution to Pension Funds	11.8
19	Sec 80CCH Deduction in respect of contribution to Agnipath Scheme	11.8
20	Sec 80G Donations	11.8
21	Sec 80GG Deduction for Rent Paid	11.9
22	Sec 80JJA Bio- Degradable waste	11.9
23	Sec 80JAA Deduction for Employment	11.10
24	Sec 80PA Farm Producer Companies	11.10
25	Sec 80QQB Royalty Income of Authors	11.10
26	Sec 80M Deduction in respect of certain inter-corporate dividends	11.10
27	Unsolved Questions	11.11

Sr No.	Particulars	Pg No
1	Sec 80DD	11.3
2	Sec 80EEA	11.4
3	Sec 80CCD	11.6
4	Sec 80G	11.7
5	Sec 80M	11.8
6	Impact of Sec 115BAC on Deductions	11.10



“  
GO with the  
CHOICE that  
SCARES you the MOST  
because that's the one  
that's going to  
HELP you GROW  
”

Ded  
11.1

CA CS VIJAY SARDA  +91 8956651954

www.ekatvamacademy.com/www.vlearnclasses.com

## Basics of Deduction

1. Deduction is covered under chapter VIA.
2. Deduction is Available u/s 80C-80U.
3. Deduction cannot exceed GTI. [Sec.80A]
4. Sec.80AC No deduction would be allowed to a taxpayer if income-tax return is not filled on or before the due date u/s 139[1]
5. **Deduction is not available from following:**
  - a) Capital gains u/s 111A, 112 & 112A
  - b) Casual income.
  - c) Specified Business income.
  - d) NR Presumptive Income u/s 115A to 115AD
  - e) Income of NR u/c XIAA.

## Sec 80TTA Deduction for Interest on Saving Account

[Available only if the individual/HUF exercises the option of shifting out of the default tax regime provided u/s 115BAC(1A)]  
[FA 2023]

<b>Assessee</b>	Individual or HUF [Other than Senior citizen]
<b>Qualifying Income</b>	Interest on savings account (not time deposits) earned on savings account with <ol style="list-style-type: none"> <li>a) Banking company</li> <li>b) Co-operative society doing banking business</li> <li>c) Post office</li> </ol>
<b>Deduction</b>	Minimum of the following <ol style="list-style-type: none"> <li>a. Interest on such deposits in saving account.</li> <li>b. Rs.10,000</li> </ol>

## Sec 80GGA Scientific Research & Rural Development

<b>Assessee</b>	Any Assessee not having Income from PGBP An Individual, HUF, AOP (other than a co-operative society) or BOI or an AJP will be eligible for deduction u/s 80GGA only if they have exercised the option of shifting out of the default tax regime provided u/s 115BAC(1A). [FA 2023]
<b>Contribution to</b>	<ul style="list-style-type: none"> <li>&gt; A Scientific Research Association, or to an Approved University, or College or other institutions to be used for Scientific Research/ Research in Social Science or Statistical Research.</li> <li>&gt; An Approved Association, Institution, Public Sector Company, has as its object the training of persons for implementing programme of rural development.</li> <li>&gt; Sum paid to the National Fund for rural development set up and notified by the Central Government for the purpose of carrying out rural development programmes.</li> </ul>
<b>Deduction</b>	Any Amount [100%]. However if Sum Exceed ₹2,000 then Amount should be paid via Cheque.
<b>Logics</b>	<b>No withdrawal of deduction even if approval is withdrawn:</b> Above deduction, shall not be denied merely on the ground that subsequent to the payment of such sum by the assessee, the approval of above mentioned institutions has been withdrawn.

## Sec 80GGB Contribution to Political Party by Indian CO

<b>Assessee</b>	Indian Company
<b>Contribution to</b>	Political Party or Electoral Trust [Within the meaning of Sec 182 of the Companies Act, 2013]
<b>Deduction</b>	Any Amount [100%]
<b>Restriction</b>	Amount should not be paid in Cash



## Sec 80GGC Contribution to Political Party

[Available only if the individual/HUF exercises the option of shifting out of the default tax regime provided u/s 115BAC(1A)]  
[FA 2023]

<b>Assessee</b>	Any Assessee [other than Indian Company]
<b>Contribution to</b>	Political Party or Electoral Trust [Within the meaning of Sec 182 of the Companies Act, 2013]
<b>Deduction</b>	Any Amount [100%]
<b>Restriction</b>	Amount should not be paid in Cash

An individual, HUF, AOP (other than a co-operative society) or BOI would be eligible for deduction u/s 80GGC only if they have exercised the option of shifting out of the default tax regime provided u/s 115BAC(1A). A co-operative society will not be eligible for deduction if it opts for special provisions of sec 115BAD/115BAE. [FA 2023]

## Sec 80TTB Interest on Deposits

[Available only if the individual/HUF exercises the option of shifting out of the default tax regime provided u/s 115BAC(1A)]  
[FA 2023]

<b>Assessee</b>	Individual being Resident [Being Senior Citizen]
<b>Qualifying Income</b>	Interest on deposit earned from a) Banking company b) Co-operative society doing banking business c) Post office
<b>Deduction</b>	<b>Minimum of the following :</b> a. Interest on deposits b. ₹50,000
<b>Other Condition</b>	Corresponding amendment has been proposed in Sec 194A to provide that TDS is required from payment of interest to senior citizen upto ₹50,000

## Sec 80U Deduction for Person with Disability

[Available only if the individual/HUF exercises the option of shifting out of the default tax regime provided u/s 115BAC(1A)]  
[FA 2023]

<b>Assessee</b>	Individual being Resident	
<b>Condition</b>	The assessee, at any time during the PY, is certified by the medical authority to be a person with disability. The assessee furnishes a copy of certificate issued by the medical authority in the prescribed form along with the return of income in respect of the A.Y. for which the deduction is claimed.	
<b>Amount of Deduction</b>	<b>Disability of the assessee</b>	<b>Amount of deduction</b>
	Other than severe disability	₹75,000
	Sever disability [80%]	₹1,25,000
Deduction is allowed irrespective of expense incurred by the assessee.		

## Sec 80DD Maintenance of Disable Dependent

[Available only if the individual/HUF exercises the option of shifting out of the default tax regime provided u/s 115BAC(1A)]  
[FA 2023]

<b>Assessee</b>	Individual/HUF being Resident	
<b>Condition</b>	<p>1) Medical treatment (including nursing), training &amp; rehabilitation of a dependant, being a person with disability</p> <p>2) Deposited any amount under a scheme (framed by the LIC or any other approved insurer), which would provide for payment of annuity or lump sum amount for the benefit of such dependent, in the event of the death of the assessee.</p> <p>3) It should provide for payment of annuity or lumpsum</p> <p>a) In the event of death or</p> <p>b) Attending the age of 60 yrs or more by such individual or member of HUF</p>	
<b>Amount of Deduction</b>	<b>Disability of the assessee</b>	<b>Amount of deduction</b>
	Other than severe disability	₹75,000
	Sever disability[80%]	₹1,25,000
<b>Deemed Income</b>	<p>Deduction is Allowed on Actual Payment Basis</p> <p>Relative includes - Parents, spouse, brother, sister &amp; any member of HUF</p> <p>If the dependent ( being disable) predeceases the individual or member then the amount deposited would be treated as deemed income. However, such deeming provision would not apply to the amount received by dependent being a person with disability, before his death, by way of annuity or lumpsum under the scheme mentioned in point B when individual or member attend 60 yr or more.</p>	

Ded  
11.4

CA CS VIJAY SARDA  +91 8956651954

## Sec 80DDB Deduction w.r.t medical treatment

[Available only if the individual/HUF exercises the option of shifting out of the default tax regime provided u/s 115BAC(1A)]  
[FA 2023]

<b>Assessee</b>	Individual/HUF being Resident	
<b>Condition</b>	Expenditure incurred on the medical treatment of relative. [Specified Diseases in Rule 11D- Neurological disease, Cancer; Chronic Renal Failure, Thalassemia.]	
<b>Amount of Deduction</b>	<b>Dependent</b>	<b>Amount of deduction</b>
	1. Other than senior citizen	Actual or ₹40,000, whichever is less
	2. Senior citizen	Actual or ₹100000,
	3. Very senior citizen	Whichever is less
<b>Meaning of Various Terms</b>	Deduction is Allowed on Actual Payment Basis	
	<b>Dependent</b>	<b>Person Covered</b>
	Individual	Himself; Spouse, children, parents, brothers and sisters of the individual.
	HUF	Any Member

## Sec 80D Medical Treatment

[Available only if the individual/HUF exercises the option of shifting out of the default tax regime provided u/s 115BAC(1A)]  
[FA 2023]

<b>Assessee</b>	Individual/HUF	
<b>Mode of investment</b>	<p>Medical Insurance - Pay by any mode other than cash</p> <p>CG health scheme - Pay by any mode other than cash</p> <p>Approved scheme - Pay by any mode other than cash</p> <p>Preventive health checkup - Cash / other mode allowed</p> <p>Exp on super senior citizen - Any mode other than cash</p>	
<b>Deduction</b>	<p>Assessee + Spouse + Dependent child: Actual or 25000 whichever is lower</p> <p>Parents: Actual or 25000 whichever is lower</p> <p>If any person is senior citizen : actual or 50000 WIL.</p>	

www.ekatvamacademy.com/ www.vlearnclasses.com



### Other Points:

<b>Individual</b>	Name of Individual/Spouse/Parents & dependent Children.
<b>HUF</b>	In the Name of any member.

Expense for preventive health checkup of assessee/his family is included in the total deduction, subject to a max of ₹5000.

Payment shall be made out of income chargeable to tax.

Medical Exp of very senior citizen is restricted to ₹30000

**Not. 9/2018 - Contribution in Health Scheme of Department of Atomic Energy would qualify for deduction u/s 80D**

In case of single premium health insurance policies which covers more than 1 year, deduction shall be allowed on proportionate basis for all those yrs for which cover provided, subj. specified monetary limit

## Sec 80EEB Tax Incentive for Electric Vehicle

**[Available only if the individual/HUF exercises the option of shifting out of the default tax regime provided u/s 115BAC(1A)]**  
**[FA 2023]**

<b>Assessee</b>	Individual
<b>Condition</b>	1) Interest on Loan taken for Purchase of Electric Vehicle from any Financial Institution/NBFC 2) Loan must be taken between April'19 to March'23 3) Assessee does not own any other Electric Vehicle on the date of sanction
<b>Amount of Deduction</b>	Interest Paid or 1,50,000 - whichever is lower

“**Electric Vehicle**” means a vehicle which is powered exclusively by an electric motor whose traction energy is supplied exclusively by traction battery installed in the vehicle & has such electric regenerative braking system, which during braking provides for the conversion of vehicle kinetic energy into electrical energy.

## Sec 80EE Interest on Housing Loan

**[Available only if the individual/HUF exercises the option of shifting out of the default tax regime provided u/s 115BAC(1A)]**  
**[FA 2023]**

<b>Assessee</b>	Individual (R/NR)
<b>Payment for</b>	Paid Interest on housing loan
<b>Amount of Deduction</b>	> <b>Amount of Interest Paid or 50,000 whichever is lower</b> Only Interest is allowed and not principal amount. First Deduction is to be claimed u/s 24(b) of House Property (upto 2L) & remaining interest deduction u/s 80EE.
<b>Condition</b>	> Loan should be taken from bank or financial institute for acquisition of Residential property > Purchase Price of House upto 50lakhs > Loan should be sanctioned between 01/04/16 to 31/03/2017 > Loan amount upto 35 Lakhs > Assessee does not own any Residential house on the date of sanction of loan

## Sec 80E Interest on Education Loan

**[Available only if the individual/HUF exercises the option of shifting out of the default tax regime provided u/s 115BAC(1A)]**  
**[FA 2023]**

<b>Assessee</b>	Individual (R/NR)
<b>Payment for</b>	Paid Interest on education loan [out of income chargeable to Tax] taken for Own/Relative's Educ.
<b>Deduction</b>	> Any Amount of Interest Paid [100%]; Only Interest is allowed and not the principal amount. > Deduction is available from the year from which assessee start paying interest & 7 immediately succeeding A.Y.
<b>Meaning &amp; Condition</b>	> Relative : Spouse, Children, For Whom Assessee is Guardian > Loan be taken from approved financial institute

Ded  
11.5

CA CS VIJAY SARDA  +91 8956651954

[www.ekatvamacademy.com/](http://www.ekatvamacademy.com/) [www.vlearnclasses.com](http://www.vlearnclasses.com)

## Sec 80EEA Deduction in respect of interest on loan taken for certain HP

[Available only if the individual/HUF exercises the option of shifting out of the default tax regime provided u/s 115BAC(1A)]  
[FA 2023]

Assessee	Individual (Other than covered in 80EE) (R/NR)
Payment for	Paid Interest on Loan borrowed for SOP
Amount of Deduction	Additional Benefit upto ₹150000 apart from Available in Sec.24(b). Benefit will be available till the date of Repayment
Meaning & Condition	<ul style="list-style-type: none"> <li>&gt; Loan should from bank / approved financial institute.</li> <li>&gt; Actual amount of interest paid is available</li> <li>&gt; The Stamp Value of the House does not exceed ₹45L</li> <li>&gt; Loan should be Sanctioned Between 2019-22</li> <li>&gt; Should not own more any HP as on date of sanction</li> <li>&gt; If deduction is taken under this sec, deduction under other sec is not allowed</li> </ul>

## Sec 80C Deduction w.r.t various Investment

[Available only if the individual/HUF exercises the option of shifting out of the default tax regime provided u/s 115BAC(1A)]  
[FA 2023]

Assessee	Individual/HUF irrespective of Residential Status
Investment	See list below
Maximum Deduction	Maximum deduction along with sec 80CCC and 80CCD or independently u/s 80C is restricted to Rs.150000. [80CCCE]
Condition	<ul style="list-style-type: none"> <li>&gt; Investment is made in approved scheme</li> <li>&gt; Payment need not necessarily made out of income chargeable to tax</li> <li>&gt; Deduction shall be made only on payment basis not on accrual basis.</li> </ul>

## Qualifying savings/investments

Any sums paid or deposited in PY by assessee	Individual	HUF
To effect or to keep in force a Life insurance on life of following persons: 1. The children may male/female, married/unmarried, dependent/independent. 2. The premium exceeding 10% of sum assured is not eligible for deduction. [If policy is issued before 31.03.12 then it shall be 20%] 3. 15% of SA for person covered u/s 80U/80DDB	Self/ Spouse /Child	Any Member
To effect or to keep in force a non-commutable deferred annuity, (other than annuity plan of LIC, other insurer), on the life of the individual, the wife or husband and any child of such individual.	Self/ Spouse /Child	NA
By way of deduction from the salary of Govt. EE, being a sum deducted, for the purpose of securing to him a deferred annuity/making provision for his spouse or children, max upto 1/5th of the salary.	Self	NA
As a contribution by an individual to any statutory PF or RPF.	Self	NA
As a contribution by an individual/HUF to any PPF, Min-500 Max-150000	Self/ Spouse/Child	Any Member
As subscription to NSS-1992.	Self	NA
As subscription to NSC- VIII issue. Note: Int accrued on these certificates which is deemed to be reinvested, also qualifies for deduction.	Self	NA
As a contribution in the Unit-linked Insurance Plan (ULIP)	Self/ Spouse/Child	Any Member
To effect or to keep in force a contract for notified annuity plan of the LIC or any other insurer.	Self/ Spouse/Child	Any Member
Subscription to any units of any Mutual Fund referred to in section 10(23D), under any notified plan.	Self	NA
As a contribution by an individual to Retirement Benefit Pension Fund of UTI.	Self	NA
As subscription to Home Loan Account Scheme of National Housing Bank.	Self	NA

Ded  
11.6

CA CS VIJAY SARDA  +91 89566651954

www.ekatvamacademy.com/www.vlearnclasses.com



Subscription to notified deposit scheme.	Self	NA
Tuition fees paid by individual, whether at the time of admission or thereafter - Including Stamp duty & registration fees.	Maximum 2 children	NA
> To any university, college, school/other educational institution situated in India; > For the purpose of full-time education of any two children of such individual.		
<b>RE-PAYMENT OF HOUSING LOANS</b>		
Repayment of Housing loan except int on borrowed capital provided house is taken for residential purpose & assessee should not transfer the house property for 5 years. Including Stamp Duty.	Self	NA
As subscription to equity shares/deb forming part of any eligible issue of capital approved by Board of public co engaged in infrastructure including power sector or public financial institution.	Self	NA
As term deposit—		
(a) For a fixed period of not less than 5 years with a scheduled bank; &	Self	NA
(b) Which is in accordance with scheme framed & notified, by CG	Self	NA
As subscription to bonds of NABARD	Self	NA
In an account under the senior Citizen Saving Scheme Rules, 2004.	Self	NA
As 5 year time deposit in an a/c under Post Office Time Deposit Rules, 1981.	Self	NA
Sukanya Samriddhi Account [Noti.5/2015]	Self/ Spouse / Child	Any Member
Deposit by CG Employee as contribution to his Tier-II A/c of Pension Scheme	Self	NA

Ded  
11.7

## Sec 80CCC Contribution to certain funds

[Available only if the individual/HUF exercises the option of shifting out of the default tax regime provided u/s 115BAC(1A)] [FA 2023]

<b>Condition 1</b>	The assessee is an Individual. [Irrespective of status]
<b>Condition 2</b>	The assessee has paid or deposited any amount for any annuity plan of LIC of India (or any other insurer) for receiving pension from fund referred to in sec 10(23AAB)
<b>Condition 3</b>	The amount is paid out of his income chargeable to tax. Any amount withdrawn/pension received from the plan is taxable in hands of the assessee or nominee in the year of receipt
<b>Deduction</b>	Independently – ₹1,50,000 Overall – ₹1,50,000 Or actual, whichever is lower.

## Sec 80RRB Royalty on Patents

[Available only if the individual/HUF exercises the option of shifting out of the default tax regime provided u/s 115BAC(1A)] [FA 2023]

<b>Assessee</b>	Individual Being > Resident > Patentee: Person who is true and first inventor of the patent and whose name is entered on the patent which is registered on or after 1.4.2003 under the Indian Patents Act, 1970.				
<b>Deduction</b>	<table border="1"> <tr> <td>Earned in India</td> <td><b>Minimum of the following:</b> &gt; 100% of such income; or &gt; ₹3,00,000</td> </tr> <tr> <td>Earned outside India</td> <td><b>Minimum of the following:</b> &gt; Income in respect of money brought into India in convertible foreign exchange within prescribed time limit; or &gt; ₹3,00,000</td> </tr> </table>	Earned in India	<b>Minimum of the following:</b> > 100% of such income; or > ₹3,00,000	Earned outside India	<b>Minimum of the following:</b> > Income in respect of money brought into India in convertible foreign exchange within prescribed time limit; or > ₹3,00,000
Earned in India	<b>Minimum of the following:</b> > 100% of such income; or > ₹3,00,000				
Earned outside India	<b>Minimum of the following:</b> > Income in respect of money brought into India in convertible foreign exchange within prescribed time limit; or > ₹3,00,000				
<b>Conditions</b>	<ul style="list-style-type: none"> <li>&gt; The assessee must furnish a certificate in prescribed form (Form No. 10CCE), duly verified by the person responsible for making such payment to the assessee</li> <li>&gt; Deduction should not exceed royalty as per licence</li> <li>&gt; Double deduction not permissible:</li> </ul>				



## Sec 80CCD Contribution to Pension Funds

[Available only if the individual/HUF exercises the option of shifting out of the default tax regime provided u/s 115BAC(1A)]  
[FA 2023]

<b>Condition</b>	1) The assessee is an Individual, who is - a) Employed by CG/SG or any other employer, or b) Any self employed person. 2) Assessee has, during previous year, paid or deposited any amount in his account under pension scheme notified by the > CG/SG/Employer/Assessee. > Atal Pension Yojna is also Eligible.
<b>Deduction</b>	CG/SG/Employer/Employee- 10% of salary Any other individual-20% of Gross Total Income [Basic+DA(R)]
<b>80CCD[1B] Own Contribution</b>	Additional deduction upto 50000 shall be allowed other than contribution covered u/s 80CCD[1] Example: Assessee contribution 140000 towards NPS & GTI is 560000 in this case deduction shall be 20% of GTI = 112000 u/s 80CCD[1] Balance deduction = 28000 u/s 80CCD[1B]
<b>80CCD[2] Own Contribution</b>	Employer contribution is first taxable under head salary & then he [employee] gets deduction u/s 80CCD[2] lower of a. Employers contribution b. 14% (Central Government) or (State Government) / 10% of salary (others)
<b>Other notes</b>	1) <b>As per 10[12A]</b> any payment received from the NPS by Assessee upon closure of his account/on his opting out of the pension scheme to the extent of 60% [40% Taxable] of the total amount payable to him at the time of such closure or his opting out of scheme.[If amount is received by legal heir it is fully exempt]. 2) <b>As per 10[12B]</b> Any payment from the NPS to an EE under pension scheme on partial withdrawal made out of his account in accordance with terms & conditions, specified under the Pension Fund Regulatory and Development Authority Act, 2013 and the regulations made thereunder, to the extent it does not exceed 25% of the amount of contributions made by him;

Ded  
11.8

## Sec 80CCH Deduction in respect of contribution to Agnipath Scheme

<b>Assessee</b>	Individual
<b>Contribution to</b>	Where assessee enrolled in the Agnipath Scheme or Agniveer Corpus Fund on or after the 1st Nov, 22, has paid or deposited any amount
<b>Amount of Deduction</b>	100% of amount so paid or deposited.

**Notes:**  
1. Where CG makes any contribution to the account of an assessee in the Agniveer Corpus Fund the assessee shall be allowed a deduction = 100%  
2. "Agnipath Scheme" means the scheme for enrollment in Indian Armed Forces introduced on 29th Dec, 22 of the Government of India in the Ministry of Defence;  
3. "Agniveer Corpus Fund" means a fund in which consolidated contributions of all the Agniveers and matching contributions of CG along with interest on both these contributions are held. [FA 2023]

## Sec 80G Donation

<b>Assessee</b>	All Assessee In case of an individual, HUF, AOP (other than a co-operative society) or BOI or an artificial juridical person, deduction would be available only if they have exercised the option of shifting out of the default tax regime provided u/s 115BAC(1A). It would not be available if they pay concessional rates of tax under the default tax regime u/s 115BAC. In case of Co. and co-operative societies, deduction would not be available if they opt for the special provisions u/s 115BAA/115BAB and sec 115BAD/115BAF, respectively. In other words, deduction would be available only if they pay tax under the normal provisions of the Act. [FA 2023]																		
<b>Expense on</b>	Any donation in form of sum of money. Donation in kind is not qualified for deduction. [Rama Vera 187 ITR 308] The donation be made only to specified funds/institutions (List).																		
<b>Payment Mode</b>	If the Donation Exceed ₹2000 then only through Cheque																		
<b>Deduction</b>	% Specified in the List <b>Some items:</b> - With Qualifying Limit [10% of Adjusted Total Income] <b>Rest :-</b> Without Qualifying Limit																		
<b>Calculation of Qualifying Limit</b>	<table border="1"> <thead> <tr> <th>Particulars</th> <th>₹</th> </tr> </thead> <tbody> <tr> <td>Gross Total Income</td> <td>xxx</td> </tr> <tr> <td>Less:</td> <td></td> </tr> <tr> <td>LTCG</td> <td>(xxx)</td> </tr> <tr> <td>STCG u/s 111A(only)</td> <td>(xxx)</td> </tr> <tr> <td>Deduction u/s 80C to 80U Except 80G</td> <td>(xxx)</td> </tr> <tr> <td>Adjusted Gross Total Income</td> <td>xxx</td> </tr> <tr> <td>10% of ATI</td> <td>xxx</td> </tr> <tr> <td>Deduction = 50% or 100% of (10% of ATI)</td> <td>xxx</td> </tr> </tbody> </table> <p>While calculating Adjusted GTI, casual income like winning from lotteries etc. shall be included</p>	Particulars	₹	Gross Total Income	xxx	Less:		LTCG	(xxx)	STCG u/s 111A(only)	(xxx)	Deduction u/s 80C to 80U Except 80G	(xxx)	Adjusted Gross Total Income	xxx	10% of ATI	xxx	Deduction = 50% or 100% of (10% of ATI)	xxx
Particulars	₹																		
Gross Total Income	xxx																		
Less:																			
LTCG	(xxx)																		
STCG u/s 111A(only)	(xxx)																		
Deduction u/s 80C to 80U Except 80G	(xxx)																		
Adjusted Gross Total Income	xxx																		
10% of ATI	xxx																		
Deduction = 50% or 100% of (10% of ATI)	xxx																		



## The amount of deduction in respect of various kinds of donations is :

Trust/institution to which donation is made	Qualifying limit applies or not	% of donation eligible for ded <sup>n</sup>
National Defence Fund set up by Central Govt	No	100
Prime Minister's National Relief Fund / Prime Minister's Citizen Assistance & Relief in Emergency Situations Fund (PM Cares Fund)	No	100
Prime Minister's Armenia Earthquake Relief Fund	No	100
Africa (Public Contributions - India) Fund	No	100
National Foundation for Communal Harmony	No	100
University/any educational inst. of national Eminence	No	100
Maharashtra Chief Minister's relief Fund / Earthquake Relief Fund	No	100
Fund set up by the Govt of Gujarat for relief of the Victims of Earthquake	No	100
Zila Saksharta Samiti	No	100
National/State Blood Transfusion Council	No	100
Any fund set up by a State Govt to provide medical relief to the poor	No	100
Army Central Welfare Fund/Indian Naval Benevolent Fund/Air Force Central Welfare Fund	No	100
Andhra Pradesh CM's Cyclone Relief Fund, 1996	No	100
National Illness Assistance Fund	No	100
Chief Minister's Relief Fund/Lieutenant Governor's Relief Fund	No	100
National Sports Fund to be set up by the CG	No	100
National Cultural Fund set up by the CG	No	100
Fund for Tech Development/application by CG	No	100
National Trust for Welfare of Persons with Autism, Cerebral Palsy, Mental Retardation & Multiple Disabilities	No	100
Any sums paid by the assessee, between Jan 26 2001 to Sep 30, 2001, to any trust, institution or fund which satisfies conditions of sec 80G(5) for providing relief to victims of Guj earthquake	No	100
Prime Minister's Drought Relief Fund	No	50
National Children's Fund	No	100
The Govt./any approved local authority, institution or association, to be utilised for purpose of promoting family planning	Yes	100
Any sums paid by assessee, being a co, in the PY as donations to Indian Olympic Association or to any other association/institution established in India and notified by the CG for—	Yes	100
i) The development of infrastructure for sports & games, in India; or	Yes	50
ii) The sponsorship of sports & games, in India	Yes	50
Fund or any institution which satisfies the conditions given u/s 80G(5)	Yes	50
The Government or any local authority, to be utilised for any charitable purpose other than the purpose of promoting family planning	Yes	50
An authority constituted in India for satisfying the need for housing accommodation or for the purpose of planning, development or of cities, towns and villages, or for both	Yes	50
Any corporation referred to in sec 10(26BB) for promoting the minority community	Yes	50
Any sums paid for the renovation or repair of any such temple, mosque, gurdwara, church/other notified place.	Yes	50
Swachh Bharat Kosh set up by CG	No	100
Clean Ganga Fund set up by CG	No	100
National Fund for control of drug abuse constituted u/s 7A of the narcotic drugs	No	100

Ded  
11.9

CA CS VIJAY SARDA  +91 8956651954

## Sec 80GG Deduction for Rent Paid

[Available only if the individual/HUF exercises the option of shifting out of the default tax regime provided u/s 115BAC(1A)]  
[FA 2023]

Assessee	Individual [R/NR]														
<b>Condition</b>	<ul style="list-style-type: none"> <li>&gt; No HRA : Assessee is not receiving HRA.</li> <li>&gt; No house at place of employment: He/his spouse/minor child or HUF of which he is a member, should not own any residential house at a place where the assessee resides, perform the duties of this office, or employment or carries on his business or profession.</li> <li>&gt; A declaration in Form 10BA should be filed for expense incurred by him towards payment of rent.</li> <li>&gt; The assessee has not claimed concession in respect of self-occupied property</li> </ul>														
<b>Deduction</b>	<ul style="list-style-type: none"> <li>&gt; Lower of</li> <li>&gt; ₹5000pm (60000pa)</li> <li>&gt; 25% of Adjusted Total Income</li> <li>&gt; Rent paid (-) 10% of ATI</li> </ul>														
<b>Calculation of ATI</b>	<table border="1"> <thead> <tr> <th>Particulars</th> <th>₹</th> </tr> </thead> <tbody> <tr> <td>Gross Total Income</td> <td>XXX</td> </tr> <tr> <td>Less:</td> <td>(XXX)</td> </tr> <tr> <td>LTCG</td> <td>XXX</td> </tr> <tr> <td>STCG u/s 111A (only)</td> <td>XXX</td> </tr> <tr> <td>Deduction u/s 80C to 80U Except 80GG</td> <td>XXX</td> </tr> <tr> <td>Adjusted Gross Total Income</td> <td>XXX</td> </tr> </tbody> </table>	Particulars	₹	Gross Total Income	XXX	Less:	(XXX)	LTCG	XXX	STCG u/s 111A (only)	XXX	Deduction u/s 80C to 80U Except 80GG	XXX	Adjusted Gross Total Income	XXX
Particulars	₹														
Gross Total Income	XXX														
Less:	(XXX)														
LTCG	XXX														
STCG u/s 111A (only)	XXX														
Deduction u/s 80C to 80U Except 80GG	XXX														
Adjusted Gross Total Income	XXX														

## Sec 80JJA Bio-degradable Waste

Assessee	Any Assessee
<b>Eligible Business</b>	<ul style="list-style-type: none"> <li>Profits &amp; gains from business of collecting &amp; processing or treating of bio-degradable waste</li> <li>&gt; Generating power; or</li> <li>&gt; Producing bio-fertilizers, bio-pesticides or other biological agents; or</li> <li>&gt; Producing bio-gas or making pellets or briquettes for fuel or organic manure, he is entitled to a deduction in computing total income.</li> </ul>
<b>Deduction</b>	1st 5 years = 100% of the profit

www.ekatvacademy.com/www.vlearnclasses.com



## Sec 80JAA Deduction for Employment of new workmen

<b>Assessee</b>	Assessee to whom Section 44AB applies
<b>Deduction</b>	80% of "additional wages" paid to the "new regular workmen" employed by the assessee in the PY. The deduction shall be allowed for 3 AYs, including the AY relevant to the PY in which such employment is provided
<b>Meaning of Terms</b>	<p><b>New Regular workmen do not include –</b></p> <ul style="list-style-type: none"> <li>&gt; Employee Whose Total Remuneration exceed ₹25000pm</li> <li>&gt; Whose entire contribution is paid by Government under Pension Scheme</li> <li>&gt; Employee worked for Less than 240 days/150 days in case of apparels Business/footwear &amp; leather industry.</li> <li>&gt; Employee who does not participate in RPF.</li> </ul>
<b>Restriction</b>	<p>1) Additional Employee Cost : Total Employment paid/payable to Additional Employees employed during year.</p> <p>a) In case of existing business - Cost will be NIL if no increase in total no of employees &amp; emoluments paid otherwise than by A/c payee cheque/draft/NEFT/RTGS/other electronic mode prescribed.</p> <p>2) The assessee furnishes along with ROI report of accountant, atleast 1 Month prior to date of ROI [Form 10DA]</p>

## Sec 80PA Farm Producer Companies

<b>Assessee</b>	<p>Farm producer companies Generating Income out of -</p> <ol style="list-style-type: none"> <li>1. Marketing of agricultural produce grown by its members</li> <li>2. Purchase of agricultural implements, seeds, livestock or other articles intended for agriculture for the purpose of supplying them to its members</li> <li>3. Processing of agricultural produce of its members.</li> </ol>
<b>Deduction</b>	100% deductions of profits for a period of 5 years
<b>Conditions</b>	<ol style="list-style-type: none"> <li>1. There should be farm producer company.</li> <li>2. Total turnover of up to ₹100 crores during the FY</li> <li>3. Engaged in Specified Activities</li> <li>4. To be eligible, profits &amp; gains attributable to such business for the PY relevant to an AY commencing on or after the 1st day of April, 2019, but before the 1st day of April, 2025.</li> </ol>

## Sec 80QQB Royalty Income of Authors

[Available only if the individual/HUF exercises the option of shifting out of the default tax regime provided u/s 115BAC(1A)] [FA 2023]

<b>Assessee</b>	<p>Individual Being</p> <ul style="list-style-type: none"> <li>&gt; Resident</li> <li>&gt; An Author (Including Joint Author of Book) being a work of literary, artistic or scientific nature</li> </ul>
<b>Deduction</b>	<p>Lumpsum Royalty - Actual or ₹3L, whichever is lower</p> <p>Other than above - Upto 15% of value of book sold</p>
<b>Conditions</b>	<ol style="list-style-type: none"> <li>1) The assessee must furnish a certificate in prescribed form (Form No. 10CCD), duly verified by the person responsible for making such payment to the assessee,</li> <li>2) If the income is earned outside India, the assessee must furnish a certificate, in the prescribed form (Form No. 10H) from the prescribed authority (i.e. RBI, see rule 29A).</li> <li>3) If royalty is earned outside India the deduction is allowed only if such royalty is brought to India in convertible Forex within 6m from the end of PY or time allowed by RBI.</li> </ol>

## Sec 80M Deduction in respect of certain inter-corporate dividends

**Sec 80M(1)** - Where the GTI of a domestic company in any PY includes any income by way of dividends from any other domestic company or a foreign co. or a business trust, there shall, in accordance to the provisions of this sec, be allowed in computing the total income of such domestic Co. a **deduction** : a) Equal dividends received  
b) Dividend distributed by it on or before the due date.

**Which ever is lower.**

**Sec 80M(2)** - Where any deduction, in respect of the amount of dividend distributed by the domestic company, has been allowed under sub-sec (1) in any PY, no deduction shall be allowed in respect of such amount in any other PY

**Explanation** - For the purposes of this section, the expression "due date" means the date one month prior to the date for furnishing the ROI u/s 139(1).

Ded  
11.10

CA CS VIJAY SARDA +91 8956651954

www.ekatvamacademy.com/www.vlearnclasses.com



## Unsolved Questions

### P1. Based on Sec 80C + 80G

For the A.Y. 2024-25, the Gross total income of Mr. Chaturvedi, a resident in India, was ₹ 8,18,240 which includes long-term capital gain of ₹ 2,45,000 taxable under section 112 and Short-term capital gain of ₹ 58,000. The Gross total income also includes interest income of ₹ 12,000 from savings bank deposits with banks and ₹ 40,000 interest on fixed deposits with banks. Mr. Chaturvedi has invested in PPF ₹ 1,20,000 and also paid a medical insurance premium ₹ 51,000. Mr. Chaturvedi also contributed ₹ 50,000 to Public Charitable Trust eligible for deduction under section 80G by way of an account payee cheque. Compute the total income and tax thereon of Mr. Chaturvedi, who is 70 years old as on 31.3.2024, in a tax efficient manner assuming he has exercised the option of shifting out of the default tax regime provided u/s 115BAC(1A).

### P2. Based on Sec 80C

Mr. A has commenced the business of manufacture of computers on 1.4.2023. He employed 350 new employees during the P.Y. 2023-24, the details of whom are as follows

No. of employees	Date of employment	Regular/ Casual	Total monthly emoluments per employee (₹)
75	1.4.2023	Regular	24,000
125	1.5.2023	Regular	26,000
50	1.8.2023	Casual	24,500
100	1.9.2023	Regular	24,000

The regular employees participate in recognized provident fund while the casual employees do not. Compute the deduction, if any, available to Mr. A for A.Y. 2024-25, if the profits and gains derived from manufacture of computers that year is ₹ 75 lakhs and his total turnover is ₹ 10.16 crores. What would be your answer if Mr. A has commenced the business of manufacture of footwear on 1.4.2023 assuming he has exercised the option of shifting out of the default tax regime provided u/s 115BAC(1A)?

### P3. Based on Sec 80 QQB

Mr. Aakash earned royalty of ₹ 2,88,000 from a foreign country for a book authored by him, being a work of literary nature. The rate of royalty is 18% of value of books. The expenditure incurred by him for earning this royalty was ₹ 40,000. The amount remitted to India till 30th September, 2024 is ₹ 2,30,000. The remaining amount was not remitted till 31st March, 2025. Compute the amount includible in the gross total income of Mr. Aakash and the amount of deduction which he will be eligible for u/s 80QQB if he has exercised the option of shifting out of the default tax regime provided under section 115BAC(1A).

### P4. Based on Sec 80D

Mr. A, aged 40 years, paid medical insurance premium of 20,000 during the P.Y. 2023-24 to insure his health as well as the health of his spouse. He also paid medical insurance premium of ₹ 47,000 during the year to insure the health of his father, aged 63 years, who is not dependent on him. He contributed ₹ 3,600 to Central Government Health Scheme during the year. He has incurred ₹ 3,000 in cash on preventive health check-up of himself and his spouse and ₹ 4,000 by cheque on preventive health check-up of his father. Compute the deduction allowable under section 80D for the A.Y. 2024-25 if Mr. A has exercised the option of shifting out of the default tax regime provided under section 115BAC(1A).

### P5. Based on Sec 80E

Mr. B has taken three education loans on April 1, 2023, the details of which are given below:

Particulars	Loan 1	Loan 2	Loan 3
For whose education loan was taken	B	Son of B	Daughter of B
Purpose of loan	MBA	B.Sc.	B.A.
Amount of loan	5,00,000	2,00,000	4,00,000
Annual repayment of loan	1,00,000	40,000	80,000
Annual repayment of interest	20,000	10,000	18,000

Compute the amount deductible u/s 80E for the A.Y. 2024-25 if Mr. B has exercised the option of shifting out of the default tax regime provided under section 115BAC(1A).

Ded  
11.11

# EXEMPTIONS

Sr No	Particulars	Pg No
1	Summary Table	12.2
2	Sec 10AA Tax Holiday for Units Established in SEZ	12.3
3	Unsolved Questions	12.4

“  
**WELL DONE**  
is **BETTER**  
than  
**WELL SAID**  
”





Section	Particulars	Who are entitled to	Condition
10(1)	Agricultural income	Any Assessee	Ref AI
10(2)	Amount received out of family income, or in case of impartible estate, amt received out of income of family estate	Individual as member of HUF	
10(2A)	Partner's share in total income of firm (which includes LLP's)	Partner of a firm	
10(4)(ii)	Interest received on NR (External) A/c	Individual NR	
10(10D)	At present Any sum received under a life insurance policy including bonus on such policy but excluding sums received w/s SODDA (s) and under a Keyman Insurance policy is exempt provided the premium does not exceed 10% of actual capital sum assured in any year. [15% for person with disability]	Any Assessee	Ref Deduction
10(6)(ii)	The remuneration received	Official of : a) Embassy b) High comm. c) Legation d) Commission e) Consulate f) Trade rep. of Foreign st. g) Member of staff of above	1. Rem by our official should be exempt 2. Such officers not be engaged in any other biz/prof in India
10(6)(vi)	Remuneration received for services rendered in India to foreign enterprise	Employee of a foreign enterprise	1. Foreign Ent not engaged in any biz/trade 2. EE stay in Ind doesn't exceed 90 days in PY 3. Rem not liable to be deducted from the ERs income chargeable to tax under the Act
10(6)(viii)	Salary received for services rendered on foreign ship	Non Citizen NR employee	Total stay in India does not exceed 90 days during the PY

Exem  
12.2

10(6)(ix)	Remuneration received from Foreign Govt (ER) during stay in India for specified training	EE	Remuneration received in connection with their training in any establishment or office or in any undertaking owned by - a) Govt b) Co wholly owned by CG & SG or jointly by CG & 1/more SG c) Any co which is subsidiary of a co ref above d) Any stat corp e) Any society registered, which is wholly owned by CG & SG or jointly by CG & 1/more SG Service can be rendered in or outside India
10(6D)	Royalty income or fees for technical services received from National Technical Research Org. (NTRO)	Non-Corporate NR & Foreign Cos	Received/receivable from CG/SG/local authority on account of any disaster. No exemption if already allowed as deduction under this Act
10(10BC)	Compensation received on account of disaster	Individual/legal heir	
10(11A)	Any contribution in Sukanya Samriddhi Account, Rules	Any Assessee	
10(16)	Educational scholarship	Individual	Granted to meet cost of education
10(17)	Payments to MPs & MLAs > Daily allowance > Constituency Allowance of MPs > Constituency allowance of MLAs	MP / MLA	Reason of membership of Parliament or state legislature under any Act or rules
10(17A)	Awards for literary, scientific & artistic works & other awards by Govt	Any Person	Approved by CG in public interest
10(18)	Pension received by recipient of gallantry awards	Individual who is an employee of CG/SG/Family Member	Awarded "Param Vir Chakra" or "Maha Vir Chakra" or Vir Chakra or such other gallantry award notified by the CG in this behalf
10(26AAA)	Specified income of a Sikkimese Individual. Exemption will not be available to a Sikkimese woman who, on or after 1st April, 2008, marries non-Sikkimese individual	Sikkimese Individual	Following income will be exempt - a) Income from any source in State of Sikkim; b) Income by way of dividend interest on securities

## Sec 10AA Tax Holiday for Units Established in SEZ

### Assessee who are eligible for exemption:

- > All categories of assessee who derive any profits or gains from an undertaking, being a unit, engaged in the manufacturing or production of article

### Essential conditions to claim exemption:

The exemption shall apply to an undertaking which fulfills the following conditions:

- > It has begun or begins to manufacture or produce articles or things or provide any service in any SEZ during PY relevant to A.Y. 2006-07 any subsequent AY but not later than A.Y. 2020-21.
- > It should not be formed by splitting up or reconstruction of business already in existence except given in section 33B.
- > It should not be formed by transfer of machinery or plant previously used for any purpose to new biz. However, deduction u/s 10AA will be available if total value of machinery or plant transferred does not exceed 20% of the total value of machinery or plant used in business.

**For this purpose, any machinery or plant which was used outside India by any person other than the assessee shall not be regarded as machinery or plant previously used for any purpose if the following conditions are fulfilled:**

- a) Such machinery or plant was not at any time used in India;
- b) Such machinery or plant is imported into India from any country outside India; and
- c) No deduction on account of depreciation has been allowed or allowable under this Act in respect of such machinery or plant to any person earlier for any prior period.
- d) The assessee should furnish in the prescribed form, along with the return of income, the report of a chartered accountant certifying that the deduction has been correctly claimed.

<b>10(30)</b>	Tea board subsidy	Any assessee engaged in business of growing & manufacturing tea	<ul style="list-style-type: none"> <li>&gt; Subsidy should have been recd under any scheme for replantation/replacement of the bushes/for rejuvenation or consolidation of areas used for cultivation of tea, as notified by CG</li> <li>&gt; Assessee should furnish a certificate from the Tea Board, as to the subsidy received by him during PY, to AO along with his return of the relevant AY/within the time extended by AO for this purpose.</li> </ul>
<b>10(31)</b>	Other subsidies	Any assessee engaged in business of growing & manufacturing rubber, coffee, cardamom/specified commodity	<ul style="list-style-type: none"> <li>&gt; Subsidies should have been received from or through Rubber, Coffee, Spices/any other Board in respect of any other commodity under any scheme for replantation or replacement of rubber, coffee, cardamom or other plants for rejuvenation or consolidation of areas used for cultivation of all such commodities</li> <li>&gt; Assessee should furnish a certificate from the Board, as to the subsidy received by him during PY, to the AO along with his return of relevant AY/within the time extended by AO for this purpose</li> </ul>
<b>10(35)</b>	Income from units from the Administrator of specified undertaking/ specified company/Mutual Fund	Any assessee	Any income except income from transfer of such units

Exem  
12.3



**Period for which deduction is available:**

- a) 100% of computed profit for first 5 years.
- b) 50% of computed profit for next 5 years.
- c) 50% of computed profit for next 5 years, if conditions are satisfied.

**No such deduction shall be allowed to an assessee who does not furnish a return of income on or before the due date u/s 139(1). [FA 2023]**

**Conditions:**

- 1) The amount credited to the SEZ Re-investment Reserve A/c.
- 2) Satisfy such other condition as may be satisfied.

**Computed Profit =**

$$\frac{\text{Profits of Unit in SEZ X Export turnover of Unit SEZ}}{\text{Total turnover of Unit SEZ}}$$

**Meaning of Export turnover:**

It means the consideration received in India or brought into India by the assessee in respect of export by the undertaking being the unit of articles or things or services.

However, it does not include-

- > Freight
  - > Telecommunication charges
  - > Insurance
- attributable to the delivery of the articles or things outside India or expenses incurred in foreign exchange in rendering of services (incl. computer software) outside India

**Deduction allowable in case of amalgamation and demerger:**

In the event of any undertaking, being the Unit which is entitled to deduction under this section, being transferred, before the expiry of the period specified in this section, to another undertaking, being the Unit in a scheme of amalgamation or demerger,

- 1) No deduction shall be admissible under this section to the amalgamating or the demerged Unit for the PY in which the amalgamation the demerger takes place; &
- 2) The provisions of this section would apply to the amalgamated or resulting Unit, as they would have applied to the amalgamating or the demerged Unit had the amalgamation or demerger had not taken place

(4A) This section applies to a Unit, if the proceeds from sale of goods or provision of services is received in, or brought into, India by the assessee in convertible foreign exchange, within a period of six months from the end of the previous year or, within such further period as the competent authority may allow in this behalf.

**Explanation 1** - "Competent authority" means the RBI or the authority authorised under any law for the time being in force.

**Explanation 2** - The sale of goods or provision of services shall be deemed to have been received in India where such export turnover is credited to a separate account maintained for that purpose by the assessee with any bank outside India with the approval of the Reserve Bank of India. [FA 2023] Section 10AA also provides for a deduction in respect of units established in SEZ from the total income of the assessee. It is available only if the assessee has exercised the option of shifting out of the default tax regime provided u/s 115BAC(1A). This deduction is not available if the assessee pays concessional rates of tax under the default tax regime u/s 115BAC. [FA 2023]

## Unsolved Questions

**P.1 Based on concept of SEZ**

Rudra Ltd is running 2 industrial undertaking 1 in SEZ(Unit A) & another in DTA (Unit B) the details are as under as on 31.03.24 amounts in Lakhs

Particulars	Total	DTAs
Total Sales	600	200
Export Sales	460	160
Net Profit	80	20

Calculate eligible deduction u/s 10AA for the AY 24-25, assuming he opted out of sec 115BAC in following situation.

- a) Both unit were setup & start manufacturing from 22.05.2012
- b) Both unit were setup & start manufacturing from 14.05.2019

Exem 12.4
--------------

# Chapter 13

## TAX DEDUCTED AT SOURCE & TAX COLLECTED AT SOURCE

Sr No	Particulars	Pg No	Sr No	Particulars	Pg No
1	Summary chart for TDS	13.2	25	Sec 194J TDS On Fees For Professional or Technical Services	13.9
2	Summary chart for TCS	13.2	26	Sec 194H TDS On Commission Or Brokerage	13.9
3	Basics	13.2	27	Sec 194A TDS On Interest Other Than On Securities	13.10
4	Sec 203A Tax Deduction & Collection A/C No	13.3	28	Sec 194I TDS On Rent	13.10
5	Sec 206AA Furnish Of PAN	13.3	29	Sec 194IA TDS On Payments on transfer of certain Immovable property other than agricultural land	13.11
6	Sec 206AB TDS to be Deducted at higher rate for non-filers of Income-Tax Return	13.3	30	Sec 194IB TDS On Rent by certain Individual / HUF	13.11
7	Sec 200 Duty of person deducting tax	13.4	31	Sec 194LA TDS On Payments of Complursory Acquisition of immovable property	13.11
8	Sec 200A Processing of TDS Statements	13.4	32	Sec 194M TDS On Payment of Individuals / HUF (Personal + Payments)	13.11
9	Sec 197 Non Deduction/Lower Deduction	13.5	33	Sec 193 TDS On Interest On Securities	13.12
10	Sec 198 Tax Deducted Is Income Received	13.5	34	Sec 194N TDS On Withdrawal In Cash	13.12
11	Sec 203 Certificate For Tax Deducted	13.5	35	Sec 194R TDS on Benefit & Perquisite in respect of Business or Profession w.e.f 1/4/22 [FA 2022]	13.13
12	Sec 201 Consequences of failure to deduct or pay	13.5	36	Sec 194Q TDS on Purchase of Goods With effect from 01.07.21	13.13
13	Surcharge & Cess On Rates of TDS	13.6	37	Sec 192A TDS On Accumulated Balance On EPF	13.14
14	Important Forms & Dates	13.6	38	Sec 192 TDS On Salary	13.14
15	Failure To Deduct TDS or Furnish Return on Time	13.6	39	Sec 194P - TDS on Pension [FA 2023]	13.15
16	Sec 194B TDS On Lottery & Casual Income	13.7	40	Tax Collected At Source	13.15
17	Sec 194BB TDS On Horse Race Winnings	13.7	41	Sec 206CC TCS at Higher Rate	13.15
18	Sec 194BA TDS on winning in Online Games [FA 2023]	13.7	42	Sec 206CCA TCS at Higher Rate	13.16
19	Sec 194D TDS On Insurance Commission	13.7	43	Sec 206C - TCS Provisions	13.16
20	Sec 194DA TDS On any sum under a insurance policy not fulfilling the conditions specified u/s 10(10D)	13.7	44	Unsolved Questions	13.19
21	Sec 194G TDS on Commission on Sale of Lottery Tickets etc	13.7			
22	Sec 194 Dividends	13.7			
23	Sec 194K TDS On Income on units other than in the nature of CG	13.8			
24	Sec 194C TDS On Payments To Contractors	13.8			

TDS  
13.1



## Summary Chart for TDS

Relevant Section	Particulars	TDS rate	Limit
Sec 192	TDS On Salary	Average rate of Income tax	Annual Salary (After deduction and exemption, exceed BEL)
Sec 192A	Receiving accumulated taxable part of PF	10%	50,000
Sec 193	Interest received on securities	10%	5,000/10,000
Sec 194 and 194K	Dividend received from Mutual funds and on company's shares	10%	5,000
Sec 194A	Interest other than Interest on Securities e.g. Fixed deposit interest	10%	40,000
Sec 194B	Winning from lottery, crosswords or any sort of game	30%	10,000
Sec 194BB	Winning from horse races	90%	10,000
Sec 194D	Insurance Commission received by an Individual	5%	15,000
Sec 194DA	Life Insurance Policies not exempt under Section 10(10D)	5%	1,00,000
Sec 194I	TDS on rent	2% For P&M/10%	2,40,000 per person
Sec 194H	Commission or brokerage received except for Insurance Commission	5%	15,000
Sec 194IA	Payment made while purchasing land or property	1% (of Consideration or SDV whichever is higher)	50L
Sec 194IB	Payment of rent by individual or HUF exceeding Rs. 50,000 per month	5%	50,000
Sec 194IC	Payment for registered Redevelopment agreement	10%	-
Sec 194M	Payment made to professional or commission or brokerage of more than Rs 50 lakh and above	5%	50L
Sec 194N	Cash withdrawal exceeding Rs 20 lakh or 1 crore as the case maybe	2% / 5%	20L or 1cr
Sec 194J	Payment of Professional Fees etc.	2% (FTS, certain Royalties, call centre) 10%(Others)	30,000
Sec 194LA	Payment for Compulsory Acquisition for immovable property	10%	2,50,000
Sec 194C	Payment to contractor	I/HUF - 1% Others-2%	Single pay - 30,000 Aggregate pay -1,00,000
Sec 194G	Commission on lottery ticket	5%	15,000
Sec 194Q	Purchase of goods	0.1%	50L
Sec 194R	Benefit & Perquisite in respect of Business & Profession	10%	20,000 pa
Sec 194BA	TDS on winning in Online Games	30%	-

CA CS VIJAY SARDA +91 8956651954

TDS  
13.2

## Summary Chart for TCS

Relevant Sec	Particulars	TCS rate
Sec 206C(1)	Alcoholic liquor for human Consumption	1%
Sec 206C(1)	Tendu leaves	5%
Sec 206C(1)	Timber obtained under forest lease	2.5%
Sec 206C(1)	Timber obtained by any mode other than a forest lease	2.5%
Sec 206C(1)	Any other forest produce not being timber or tendu leaves	2.5%
Sec 206C(1)	Scrap	1%
Sec 206C(1)	Minerals, being coal or lignite or iron ore	1%
Sec 206C(1C)	TCS on parking/toll/mining rights	2%
Sec 206C(1F)	TCS on Motor Car	1%
Sec 206C(1G)	Foreign remittance	5%/0.5%
Sec 206C(1G)	Overseas tour Program	5%
Sec 206(1H)	Sale of any other goods	0.1% (w.e.f. 1/10/20)

## Basics

Who Shall deduct	Payer
<b>On What &amp; When Benefit to Assessee</b>	On Specified payments at the time of Payment or credit If Tax is deducted at the time of Payment or credit it will be allowed as deduction otherwise it will be disallowed u/s 40(a) and be treated as income of Assessee u/s 198.
<b>Benefit to the Deductee</b>	Tax deducted & paid to CG by Deductor shall be treated as payment of tax on behalf of Assessee sec 199
<b>Clubbing &amp; TDS</b>	Where the income is assessable is assessable (partly/fully) in the hands of a person other than the deductee (ex:- minor income) credit of TDS shall be given to such other person and not to deductee Rule 37BA
<b>Sec 206AA</b>	Any deductee who is entitled to receive any sum on which tax is deductible shall furnish his PAN to Deductor otherwise Tax shall be deducted at the <b>higher rate of -</b> a) Rate Specified. b) Rate in Force. c) 20%
<b>IF TDS provision not given for any payment</b>	<b>Sec 191:</b> In the case of any income in respect of which provision is not made under the Chapter of TDS for deducting income-tax at the time of payment, and in any case where income-tax has not been deducted in accordance with the provisions of this Chap, income-tax shall be payable by the assessee directly.

www.ekatvamacademy.com/www.vlearnclasses.com

## Sec 203A Tax Deduction & Collection A/C No

1) Every person, deducting tax/collecting tax in accordance with the provisions of this, Chapter, who has not been allotted a tax deduction a/c no. or, as the case may be, a tax collection a/c no, shall, within such time as may be prescribed, apply to AO for allotment of a "tax deduction & collection account number".

### 2) Quote TAN No :

- > In all challans for payment of any sum in as per provisions of Sec 200/206C;
- > In all certificates furnished under section 203 or under section 206C;
- > In all periodic statements (at present quarterly) prepared & delivered/caused to be delivered in accordance with the provisions of sec 200(3)/206C(3),
- > In all returns, delivered as per sec 206 / 206C to any income-tax authority.

## Sec 206AA Furnish Of PAN

**Sec 206AA(1)**- Any person entitled to receive any sum or income or amount, on which tax is deductible shall furnish his PAN to the person responsible for deducting such tax failing which **tax shall be deducted at the higher of the following rates, namely :**

- (i) At the rate specified in Act; or
- (ii) At the rate or rates in force; or
- (iii) At the rate of 20%:

Provided that where the tax is required to be deducted u/s 194-O, the had been substituted. Where the PAN provided to the deductor is invalid or does not belong to the deductee, it shall be deemed that the deductee has not furnished his PAN

## Sec 206AB TDS to be Deducted at higher rate for non-filers of Income-Tax Return

- > Section 206AB shall be applicable with effect from 01-07-2021.
- > This section requires that the person (payer) who deducts TDS in case of a payee (who is a non-filer of income tax return), TDS shall be deducted at the higher rates
- > Any person who is responsible to pay any sum or amount to a specified person shall be required to deduct TDS as per sec 206AB on such sum or amount paid or payable or credited to the specified person.

**Sec 206AB(3) - "Specified person"** means a person who has not furnished ROI for the AY relevant to the PY immediately preceding the financial year in which tax is required to be deducted, for which the time limit for furnishing ROI has expired and the aggregate of TDS/TCS in his case is ₹ 50000 or more in the said previous year.

**However, the specified person would not include**

- A non-resident who does not have a permanent establishment in India; or
- A person who is not required to furnish the return of income for the assessment year relevant to the said previous year and is notified by the Central Government in this behalf. [FA 2023]

**TDS under section shall be deducted at higher of the following:**

1. At twice the rate specified in the relevant provision of the Act or
2. At twice the rate or rates in force or
3. At the rate of 5%

**Eg:** X Limited makes payment of rent against commercial property to Y Ltd Rs. 5 Lakhs on which it is required to deduct TDS @ 10% u/s 194I. Y Limited has not filed its ITR for last 3 financial years though TDS credit in its case is more than Rs. 50,000 every year. Please guide X Limited as regards TDS rates?

**Solution:** Y Limited is a specified person u/s 206AB as it fulfills both the limbs of the definition. Therefore, X Limited shall deduct TDS at the higher of: Twice of rate u/s 194I i.e.  $10\% * 2 = 20\%$  5% Thus, the effective rate of TDS shall be 20% in case of Y Limited.

TDS  
13.3

CA CS VIJAY SARDA  +91 8956651954

[www.ekatvamacademy.com/](http://www.ekatvamacademy.com/) [www.vlearnclasses.com](http://www.vlearnclasses.com)



**This Section is not applicable to TDS under Following section**

**Section 192** - TDS on Salaries

**Section 192A** - TDS on Accumulated Balance of EPF

**Section 192B** - TDS on Casual Winning

**Section 194BA** - Winning from Online Games

**Section 194BB** - TDS on winning from Horse races

**Section 194IA** - TDS on Acquisition of Property

**Section 194IB** - TDS on Rental Payment

**Section 194LBC** - TDS on Investment in Securitization Trust

**Section 194M** - TDS on Personal Payments

**Section 194N** - TDS on Cash Withdraw.

> "If the provisions of section 206AA is applicable to a specified person, in addition to the provisions of this section, the tax shall be deducted at higher of the two rates provided in this section and in section 206AA."

## Sec 200 Duty of person deducting tax

**Sec 200(1)** - Any person deducting TDS shall pay and file TDS Return within the prescribed time to CG or Such Authority as prescribe by the board

**Sec 200(2)** - The prescribe officer of Government and Employer is also required to furnish the Statement as may be prescribe

**Rectification of Statement Submitted:** The person may also deliver to the prescribed authority a correction Statement for rectification of any mistake or to add, delete or update the information furnished in the Statement delivered in such form and verified in such manner as may be specified by the authority

**Due date of payments of TDS Deducted:**

**IF Tax is Deducted:**

**During April - Feb** : By 7th of Next Month

: By 30th April of Next FY.

**March**

**Due date of TDS Return (Statement)**

**Quarter Ended**

30th June

30th Sept

31st Dec

31st March

**TDS Return Due Date**

31st July

31st Oct

31st Jan

31st May.

However, every person responsible for deduction of tax under sec 194- IA, 194-IB or 194M have to furnish to the Principal Director General of Income-tax (Systems) (in case of sections 194-IB and 194M) or Director General of Income-tax (System) or the person authorised by them, a challan-cum-statement in Form No. 26QB, 26QC or 26QD respectively, within 30 days from the end of the month of deduction of tax. [FA 2023]

## Sec 200A Processing of TDS Statements

Where a quarterly return of TDS or a correction statement has been made by a person deducting any sum (hereafter referred to in this section as deductor) u/s 200, such quarterly return shall be processed in the following manner, namely:

**a) The sums deductible under this Chapter shall be computed after making the following adjustments, namely:**

- Any arithmetical error or,
- An incorrect claim,
- The interest, if any,
- The fee, if any,

**d) The sum payable by amount of refund due to, the deductor shall be determined**

**e) An intimation shall be prepared/generated & sent to deductor specifying the sum determined to be payable by/amount of refund due to, him under clause (d);**

TDS  
13.4

CA CS VIJAY SARDA  +91 8956651954

[www.ekatvamacademy.com/www.vlearnclasses.com](http://www.ekatvamacademy.com/www.vlearnclasses.com)

## Sec 197 Non Deduction/Lower Deduction

- Where, in the case of any person or sum payable to any person, income-tax is required to be deducted at the time of credit or, as the case may be, at the time of payment at the rates in force under the provisions of sec 192, 193, 194, 194A, 194C, 194D, 194G, 194H, 194I, 194J, 194LA, 194LBB, 194LBC & 195, the AO is satisfied that total income of recipient justifies deduction of income-tax at any lower rates or no deduction of income-tax, as the case may be, the AO shall, on an application made by assessee in this behalf, give to him such certificate as may be appropriate.
- Where any such certificate is given, the person responsible for paying the income shall, until such certificate is cancelled by AO, deduct income-tax at the rates specified in such certificate or deduct no tax, as the case may be.

## Sec 198 Tax Deducted Is Income Received

All sums deducted as per this Chapter shall, for the purpose of computing income of an assessee, be deemed to be income received. Exceptions - Income received u/s 192(1A) & 194N

## Sec 203 Certificate For Tax Deducted

**Sec 203(1)** - Every person deducting tax in accordance with the foregoing provisions shall furnish to the person whose tax is deducted, a certificate to the effect that tax has been deducted, and specifying the amount so deducted, the rate at which the tax has been deducted and such other particulars as may be prescribed.

## Sec 201 Consequences of failure to deduct or pay

# Where an order is made by the Assessing Officer for the default for non Deduction or short deduction the interest shall be paid by the person in accordance with such order.

## Surcharge & Cess On Rates of TDS

### In Case of Resident Payee / Deductee:

Payee/ Deductee (i.e, to whom payment is made)	Applicability of Surcharge and Education cess
1) Companies	No surcharge or health & education cess be added
2) Any other assessee	No surcharge or education cess shall be added to the prescribed rate of TDS, However, surcharge & health & education cess shall be added on TDS on the salary, (surcharge @ 15% where taxable salary exceeds ₹ 1 cr & surcharge @ 10% where taxable salary exceeds ₹ 50 lakhs)

### In Case of Non - Resident Payee / Deductee:

Payee/Deductee (i.e, to whom payment is made)	Applicability of Surcharge and Education cess
1) Foreign Companies	<b>The rates of TDS shall be increased by:</b> a) surcharge of 2% / 5% depending upon payment. b) health & education cess of 4% in all cases,
2) Individual	<b>The rates of TDS shall be increased by:</b> a) Surch @ 10%/15%/25%/37% depend on payment b) Health & education cess of 4% in all cases
3) Any other assessee	<b>The rates of TDS shall be increased by:</b> a) Surcharge of 12% (where the payment made or to be made to payee and which is subject to tax deduction during the FY exceeds 1 cr); & b) Health & education cess of 4% in all cases,

### CIRCULAR NO,23/2017, DATED 19-7-2017

TDS on Goods and Services Tax (GST): The Board hereby clarifies that GST Shown Separately : TDS on amount excl. GST  
GST not shown Separately : TDS on whole amount  
GST for this purpose shall include CGST, SGST, IGST & UTGST

TDS  
13.5

CA CS VIJAY SARDA  +91 8956651954

[www.ekatvamacademy.com/www.vlearnclasses.com](http://www.ekatvamacademy.com/www.vlearnclasses.com)



## Important Forms & Dates

<b>Due Date for payment of TDS (Sec-200)</b>	For March Between April & Feb	30th April 7th of the month Succeeding the month in which Tax is deducted or Tax is due u/s 192(1A)																								
<b>TDS Return Sec-200(3)</b>	<b>E-Filing of TDS Return:-</b> > Deductor/Collector is responsible for e-filing of quarterly return > As per Sec 200A(2) CBDT has notified Centralized processing of statement of TDS scheme, 2013 being TRACES- TDS reconciliation analysis & correction enabling system it is 100% mandatory to quote PAN.																									
<b>Forms of TDS to be submitted by Deductor</b>	The below given form shall be accompanied by form 27A. For Salary u/s 192 Other Than Salary NR For resident transferor(Land)	<table border="1"> <thead> <tr> <th>Quarter Ending</th> <th>Due date</th> </tr> </thead> <tbody> <tr> <td>30th June</td> <td>31th July</td> </tr> <tr> <td>30th Sep</td> <td>31th October</td> </tr> <tr> <td>30th December</td> <td>31th January</td> </tr> <tr> <td>31st March</td> <td>31th May</td> </tr> </tbody> </table>	Quarter Ending	Due date	30th June	31th July	30th Sep	31th October	30th December	31th January	31st March	31th May														
Quarter Ending	Due date																									
30th June	31th July																									
30th Sep	31th October																									
30th December	31th January																									
31st March	31th May																									
<b>TDS certificate to be issued to deductee Sec 203</b>		<table border="1"> <thead> <tr> <th>TDS deducted Under 192</th> <th>Form no</th> <th>Periodicity</th> <th>Due date</th> </tr> </thead> <tbody> <tr> <td rowspan="3">TDS deducted Under 192</td> <td>16</td> <td>Annual</td> <td>31st May of following year</td> </tr> <tr> <td>16A</td> <td>Quarterly</td> <td>Within 15days of due date of filling TDS return</td> </tr> <tr> <td>16B</td> <td>Within 7days with 26QB</td> <td>7 days of deduction</td> </tr> </tbody> </table> <table border="1"> <thead> <tr> <th>Quarter Ending</th> <th>Due date</th> </tr> </thead> <tbody> <tr> <td>30th June</td> <td>15 days from the date</td> </tr> <tr> <td>30th Sep</td> <td>the date</td> </tr> <tr> <td>30th December</td> <td>of Return.</td> </tr> <tr> <td>31st March</td> <td></td> </tr> </tbody> </table>	TDS deducted Under 192	Form no	Periodicity	Due date	TDS deducted Under 192	16	Annual	31st May of following year	16A	Quarterly	Within 15days of due date of filling TDS return	16B	Within 7days with 26QB	7 days of deduction	Quarter Ending	Due date	30th June	15 days from the date	30th Sep	the date	30th December	of Return.	31st March	
TDS deducted Under 192	Form no	Periodicity	Due date																							
TDS deducted Under 192	16	Annual	31st May of following year																							
	16A	Quarterly	Within 15days of due date of filling TDS return																							
	16B	Within 7days with 26QB	7 days of deduction																							
Quarter Ending	Due date																									
30th June	15 days from the date																									
30th Sep	the date																									
30th December	of Return.																									
31st March																										

## Failure To Deduct TDS or Furnish Return on Time

### 1. Interest: -

Condition	Rate	Period of Interest	Interest payable on
Tax is not deducted by any other person (except assessee in default)	1% pm	From date on which such tax had to be deducted to the date of actual deduction	Amount of such tax not deducted.
Tax deducted but not paid	1.5% pm	From the date of deduction of such tax to the actual date of payment of such tax.	Amount of Such tax not paid

Sec	Nature of default	Penalty	Levy by
271C	Failure to deduct TDS	Sum equal to the amount of TDS	JCIT
271H	Failure to file Return of TDS	Rs.10000 to Rs.100000	AO
272A	Failure to issue TDS certificate	Rs.100 for every day of default max default= tax deductible	JCIT

## Sec 194B TDS On Lottery & Casual Income

**Note:** This sec is for Winnings from any lottery, crossword puzzle or card game or other game of any sort or from gambling or betting of any form or nature (other than winnings from any online game in respect of which TDS u/s 194BA would be applicable)[FA 2023]

Payer [Deductor]	Payee[Deductee]	Limit	Rate	Time of Deduction	Special points
Person responsible for paying any sum	Any person [R/NR]	Amount exceeding 10000	30%	At the time of payment	
					a. Where the winnings are wholly in kind or partly in cash and partly in kind but the part in cash is not sufficient to meet the liability of deduction of tax in respect of whole of the winnings, the person responsible for paying shall, before releasing the winnings, ensure that tax has been paid in respect of the winnings.
					b. Where winnings are to be credited and losses are to be debited to the individual a/c of the payee, tax has to be deducted on winnings before set-off of losses. Thereafter, the net amount, after deduction of tax and losses, has to be paid to the winner.

## Sec 194BB TDS On Horse Race Winnings

Payer [Deductor]	Any person
Payee[Deductee]	Any person [R/NR]
Limit	Amount > 10000
Rate	30%
Time of Deduction	At the time of payment

## Sec 194BA TDS on winning in Online Games [FA 2023]

Payer [Deductor]	Person responsible for paying any sum on winnings in any online game
Payee[Deductee]	Any person [R/NR]
Limit	Computed in the manner as may be prescribed, at the end of FY
Rate	@ 30%
Time of Deduction	At the end of the FY. In a case where there is a withdrawal from user account during the FY, TDS shall be deducted at the time of such withdrawal on the net winnings comprised in such withdrawal, as well as on the remaining amount of net winnings in the user account. [FA 2023]

### Special points

Where the winnings are wholly in kind or partly in cash and partly in kind but the part in cash is not sufficient to meet the liability of deduction of tax in respect of whole of the winnings, the person responsible for paying shall, before releasing the winnings, ensure that tax has been paid in respect of the winnings.

## Sec 194D TDS On Insurance Commission

Payer [Deductor]	Insurance company
Payee[Deductee]	Agent
Limit	Amount > ₹15000 in a year
Rate	5%
Time of Deduction	At time of payment or credit whichever is earlier

## Sec 194DA TDS On any sum under a insurance policy not fulfilling the conditions specified u/s 10(10D)

Payer [Deductor]	Any person
Payee[Deductee]	Any person resident in India
Limit	Amount > ₹1,00,000 or more in a year
Rate	5% on amount received - amount paid
Time of Deduction	At the time of payment
Special points	Conditions Amount should not be exempt u/s 10(10D)

## Sec 194G TDS on Commission on Sale of Lottery Tickets etc

Payer [Deductor]	Stockist, distributor, etc. of lottery tickets
Payee[Deductee]	Any Person (Resident / NR)
Limit	₹15000p.a.
Rate	5%
Time of Deduction	At the time of payment or credit whichever is earlier

## Sec 194 Dividends

Payer [Deductor]	Principal officer of any Indian Co / a company which has made prescribed arrangements for the declaration and payment of dividends (including dividends on preference shares) within India
Payee[Deductee]	Shareholder being Resident
Limit	Amount or aggregate amount > ₹ 5,000 in a FY., in case of dividend paid or credited to an individual shareholder by any mode other than cash > No threshold in other cases [FA 2023]
Rate	10%
Time of Deduction	Before making any payment by any mode
No TDS if	1. Dividend is paid by company in any mode other than cash & 2. Amount & aggregate Amount of Dividend do not Exceed 5000
Special Points	This section shall not apply to such dividend paid to- a) The LIC b) The General Insurance Corporation of India or such company in which the Corporation or such company has full beneficial interest; c) Any other insurer in respect of any shares owned by it or in which it has full beneficial interest. d) A "business trust" e) Any other person as may be notified by the Central CG

TDS  
13.7

CA CS VIJAY SARDA  +91 8956651954

www.ekatvacademy.com/ www.vlearnclasses.com



## Sec 194K TDS On Income on units other than in the nature of CG

<b>Payer [Deductor]</b>	Any person
<b>Payee [Deductee]</b>	Any person (Resident)
<b>Limit</b>	Exceed ₹ 5,000
<b>Rate</b>	10%
<b>Time of Deduction</b>	At the time of payment or credit whichever is earlier
<b>Special points</b>	TDS shall be deductible on income in respect of units - a) Units of a Mutual Fund specified u/s 10(23D); or b) Units from the Administrator of the specified undertaking; or c) Units from the specified company,  This section shall not apply - a) Where the amount of such income or, as the case may be, the aggregate of the amounts of such income credited or paid or likely to be credited or paid during the PY by the person responsible for making the payment to the account of, or to, the payee does not exceed ₹5,000; or b) If the income is of the nature of capital gains.

## Sec 194C TDS On Payments To Contractors

<b>Payer [Deductor]</b>	Specified Person being <b>Individual</b> : Total sales, gross receipts / turnover exceed 1cr.(biz)/ & HUF 50L (prof) during FY imm. preceding FY in which interest credited / paid <b>Others</b> : If Exceeds Limit
<b>Payee [Deductee]</b>	Any person resident in India
<b>Limit</b>	₹ 30,000 for single payment/aggregate amount ₹ 1,00,000
<b>Rate</b>	> In Individual or HUF: 1% > In other Case: 2%
<b>Time of Deduction</b>	At the time of payment or credit whichever is earlier
<b>Special points</b>	<b>Exemptions :</b> 1. No TDS is required in case of contracts of personal In Nature 2. W.e.f. 01.06.2015 No TDS is required in Goods transport Business which owns less than 10 goods vehicle. 3. Contract for sale of goods <b>Works:</b> • Advertisement • Broadcasting • Catering • Carriage of goods or passenger by any mode other than railway Manufacturing of Product according to requirement/ specification of a customer by using material purchased from such customer or relative as defined in Sec 40A(2), But does not include manufacturing/supplying a product according to the requirement or specification of a customer by using material purchased from a person, other than such customer. The section also provides that in above case TDS to be deducted: i) On invoice value excluding value of material, if such value is mentioned separately in the invoice; or ii) On whole of invoice value, if value of material is not mentioned separately in the invoice

## Sec 194J TDS On Fees For Professional or Technical Services

<b>Payer [Deductor]</b>	Specified Person being <b>Individual</b> : Total sales, gross receipts/turnover exceed 1cr.(biz)/ & HUF 50L(prof) during FY imm. preceding FY in which interest credited/paid <b>Others</b> : If Exceeds Limit
<b>Payee[Deductee]</b>	Any person resident in India
<b>Limit</b>	₹ 30,000 PA except Directors fees
<b>Rate</b>	Technical services (not being a professional services) or royalty where such royalty where such royalty is in the nature of consideration for sale, distribution or exhibition of cinematographic films For Operation of call Centre Other Cases
<b>Time of Deduction</b>	@ Time of Payment or credit whichever is earlier
<b>Special points</b>	At the time of payment or credit whichever is earlier 2% in case of payee engaged in business of operation of call center CBDT Notifies the services rendered by following persons in relation to the sports activities as "Professional Services" u/s 194J - NOTIFICATION NO, 88/2008 Central Board of Direct Taxes, hereby notifies the services rendered by following persons in relation to the sports activities as "Professional Services" for the purpose of the section 194J, namely: <ul style="list-style-type: none"> <li>• Sports Persons,</li> <li>• Umpires and Referees,</li> <li>• Coaches and Trainers,</li> <li>• Team Physicians and Physiotherapists,</li> <li>• Event Managers,</li> <li>• Commentators,</li> <li>• Anchors, and</li> <li>• Sports Columnists</li> </ul>

## Sec 194H TDS On Commission Or Brokerage

<b>Payer [Deductor]</b>	Specified Person being <b>Individual</b> : Total sales, gross receipts/turnover exceed 1cr.(biz)/ & HUF 50L (prof) during FY imm. preceding FY in which interest credited/paid <b>Others</b> : If Exceeds Limit				
<b>Payee[Deductee]</b>	Any person being resident				
<b>Limit</b>	₹15000				
<b>Rate</b>	5%				
<b>Time of Deduction</b>	At the time of payment or credit whichever is earlier				
<b>Special Points</b>	Commission or Brokerage other than those referred to in Sec 194D & Sec 194G > Provided also that no deduction shall be made under this sec on any commission/brokerage payable by BSNL or MTNL > Commission to EE & EE directors will form part of salary income & is liable to TDS u/s 192 of the Act & not this sec, > The transactions relating to Securities are not covered by sec 194H. Therefore, section 194H is not attracted on: <ol style="list-style-type: none"> <li>1. Brokerage and commission paid to underwriters,</li> <li>2. Brokerage and sub-brokerage on public issue of securities,</li> <li>3. Brokerage on stock exchange transactions of securities, &gt; However, TDS shall be deducted on brokerage/commission paid for commodities transactions</li> </ol>				
<b>Circular &amp; Decision</b>	TDS on payments by broadcasters or TV channels to production houses for production of content or program for telecasting - CIRCULAR NO.4/2016 <table border="1"> <tr> <td>Where the content is produced as per specifications provided by the broadcaster/telecaster</td> <td>TDS u/s 194C</td> </tr> <tr> <td>Where the telecaster/broadcaster acquires only telecasting/broadcasting rights of content already produced by the production house</td> <td>No TDS u/s 194C but liable under this chapter for TDS</td> </tr> </table>	Where the content is produced as per specifications provided by the broadcaster/telecaster	TDS u/s 194C	Where the telecaster/broadcaster acquires only telecasting/broadcasting rights of content already produced by the production house	No TDS u/s 194C but liable under this chapter for TDS
Where the content is produced as per specifications provided by the broadcaster/telecaster	TDS u/s 194C				
Where the telecaster/broadcaster acquires only telecasting/broadcasting rights of content already produced by the production house	No TDS u/s 194C but liable under this chapter for TDS				
	Tax should be deducted at source u/s 194H on amount available to agents being difference between airfare fixed by Airlines & price at which agents are enabled to sell tickets				

TDS  
13.9

CA CS VIJAY SARDA  +91 8956651954

www.ekatvamacademy.com/ www.vlearnclasses.com



## Sec 194A TDS On Interest Other Than On Securities

<b>Payer [Deductor]</b>	Specified Person being <b>Individual</b> : Total sales, gross receipts/turnover exceed 1cr.(biz) & HUF 50L(prof) during FY imm. Preceding FY in which interest credited / paid <b>Others</b> : If Exceeds Limit
<b>Payee [Deductee] Limit</b>	Any person being Resident <b>Others</b> : If payment exceeds ₹5,000 <b>Bank/PO/co</b> : If payment exceeds ₹40,000 operative society from 01.06.2015, If the bank has adopted core banking solution then limit will be per Bank wise.
<b>Rate</b>	10%
<b>Time of Deduction</b>	At the time of credit or payment whichever is earlier
<b>Special Points</b>	<b>No TDS of Following</b> : > Any banking company / co-op society engaged in banking biz (incl. co-op land mortgage bank) > Any financial corp est. by/under Central, state or Provincial Act, or The LIC of India est. under the LIC Act,1956; > The UTI est under the UTI Act,1968, or > Any Co. /co-op society carrying on business of insurance > Such other inst/class of AOP / BOI or class of inst. which CG may, notify in this behalf in Official Gazette his shall be issued on after 01.04.20 [FA'20] <b>Interest paid by Cooperative Society being a Bank</b> : Interest on FDR & recurring deposit exceeding ₹10,000 in a financial year <b>Paid to member</b> : TDS to be deducted <b>Paid to another co-operative society</b> : No TDS to be deducted <b>Paid to Others</b> : TDS to be Deducted <b>Sec 194A(5)</b> - the CG may, by notification in the Official Gazette, provide that the deduction of tax shall not be made or shall be made at such lower rate, from such payment to such person or class of persons, as may be specified in the said notification. [FA'20]
	Where core-banking solutions software not adopted No TDS shall be deducted If interest payment by each branch does not exceed ₹40,000 Where core-banking solutions software is adopted TDS shall be deducted on aggregate of interest paid by all the branches of the bank, exceed ₹ 40,000.

## Sec 194I TDS On Rent

<b>Payer [Deductor]</b>	Specified Person being <b>Individual</b> : Total sales, gross receipts / turnover exceed 1cr.(biz) & HUF 50L (prof) during FY imm. preceding FY in which interest credited paid <b>Others</b> : If Exceeds Limit
<b>Payee [Deductee] Limit</b>	ANY person resident in India Exceeds ₹2,40,000 p.a. per co-owner (including Advance Rent & Arrears of Rent)
<b>Rate</b>	<b>For use of P &amp; M: Upto 2%</b> <b>For use of other asset: Upto 10%</b>
<b>Time of Deduction</b>	At the time of payment or credit whichever is earlier
<b>Meaning of Terms</b>	"Rent" means any payment, by whatever name called, under any lease, sublease, tenancy or any other agreement or arrangement for the use of (either separately / together) any. a) Land; or b) Building (including factory building); or c) Land appurtenant to a building (including factory building); or c) Machinery; or e) Plant; or f) Equipment; or g) Furniture; or h) Fittings, whether or not any or all of the above are owned by the payee.
	1. No TDS on Rent credited or paid to a business Trust. 2. TDS is also required to be deducted on advance rent. Circular No. 5/2001 3. Where the share of each co-owner in the property is definite & ascertainable, the limit of 1.8L will be applicable to each co-owner separately 4. <b>JAPAN AIRLINES CO. LTD, V. COMMISSIONER OF INCOME-TAX [2015] [SC]</b> Case: Landing & parking charges payable by Airlines in respect of aircrafts are not for the 'use of land' per se but the charges are in respect of number of facilities provided by Airport Authority of India. Thus, landing & parking charges payable by Airlines would attract TDS u/s 194C & not u/s 194-I 5. Circular No. 21/2017 - Non-applicability of sec 194-1 on remittance of Passenger Service Fees (PSF) by an airline to an airport operator according to Bombay High Court, sec 194-1 shall not be attracted on payment of passenger service fee by an airline to an air operator. The Board has accepted the above view of High Court of Bombay. Accordingly, It is now a settled position that sec 194-1 of Act, will not apply on PSF. 6. TDS on Non-refundable deposit made by Tenant - CBDT Clarification Non Refundable - TDS is deducted Refundable - TDS is not deducted
<b>Special points</b>	

7. Provision of 194-I is not applicable to the cooling charges paid by the customers of the cold storage.
8. TDS on Payment made to Hotels - Circular No. 5/2002  
Regular basis Accommodation - TDS is deducted  
Other basis Accommodation - No TDS is deducted
9. No deduction shall be made under this sec where the income by way of rent is credited or paid to a business trust, being a real estate investment trust, in respect of any real estate asset, ref to in sec 10(23FCA), owned directly by such business trust

### Special points

## Sec 194IA TDS On Payments on transfer of certain Immovable property other than agricultural land

<b>Payer [Deductor]</b>	Any assessee
<b>Payee [Deductee]</b>	Resident Assessee
<b>Limit</b>	Consideration of Immovable property & SDV of such property both Exceed 50 Lakh.
<b>Rate</b>	1% of consideration or stamp duty value of such property, whichever is higher
<b>Time of Deduction</b>	Transfer of assets on or after 01.07.2013
<b>Special Points</b>	<p>The Deductor shall remit the TDS to CG in form 26QB and issue form 16B as certificate to payee.</p> <ol style="list-style-type: none"> <li>1) Therefore, if the immovable property is purchased from a NR person for any value, no TDS is required to be deducted under this sec. However, TDS shall be deducted u/s 195.</li> <li>2) In case the seller does not have PAN, then instead of 1%, TDS will be applicable @ 20% because of sec 206AA of Income-tax Act'61.</li> <li>3) In the case of property whose sale price is 50 lakhs or more and in the event part payment is being made for the purchase, then such TDS would be required to be deducted on every part payment of consideration and not at the time of final tranche of payment.</li> <li>4) If sellers jointly own a property and sells for a total consideration of 50L or more, then sec 194-IA is attracted even if each co-owner's consideration is less than 50 lakhs</li> <li>5) TDS is required to be deducted irrespective of the fact that immovable property is held as capital asset/stock-in trade by the buyer and seller</li> <li>6) In case sec 194-IA is attracted then purchaser isn't required to obtain TAN, i.e Tax Deduction Account Number i.e, sec 203A is not applicable.</li> </ol> <p>Consideration shall incl. all charges of the nature of club membership fee, car parking fee, water or electricity facility fee, maintenance, advance fee/similar which are incidental to the property</p>

## Sec 194IB TDS On Rent by certain Individual / HUF

<b>Payer [Deductor]</b>	Individual/HUF
<b>Payee [Deductee]</b>	Any person Resident
<b>Limit</b>	Exceed ₹50000 per month
<b>Rate</b>	5%
<b>Time of Deduction</b>	At the time of payment or credit of such rent, for the last month of the FY / Tenancy whichever is earlier.
<b>Other Points</b>	<ol style="list-style-type: none"> <li>1) Deduction should not exceed rent for last month</li> <li>2) Sec 194IB(4) - Where TDS is deductible as per the provisions of sec 194A or section 206AB [FA, 2022], such deduction shall not exceed the amount of rent payable for the last month of the FY or the last month of the tenancy. [That means if Section 206AB applies TDS can exceed Rent Payable]</li> </ol>

## Sec 194LA TDS On Payments of Compulsory Acquisition of immovable property

<b>Payer [Deductor]</b>	Any Person
<b>Payee [Deductee]</b>	Resident
<b>Limit</b>	Exceeds ₹2,50,000
<b>Rate</b>	10%
<b>Time of Deduction</b>	At the time of payment [State of Kerala Vs. Mariaama]
<b>Special Points</b>	No TDS to be deducted if compulsory acquisition of Rural Agriculture land

## Sec 194M TDS On Payment of Individuals/HUF (Personal Payments)

<b>Payer [Deductor]</b>	Individual or a HUF (other than those who are required to deduct income-tax as per the provisions of sec 194C, sec 194H/sec 194J)
<b>Payee [Deductee]</b>	Any person [Resident]
<b>Limit</b>	Exceed ₹ 50,00000 during a FY
<b>Rate</b>	5%
<b>Special Points</b>	<ul style="list-style-type: none"> <li>&gt; Sums, credited or paid to a resident during a F.Y.</li> <li>&gt; Provisions of sec 203A shall not apply to a person required to deduct tax as per provisions of this sec.</li> </ul>

TDS  
13.11

CA CS VIJAY SARDA  +91 8956651954

www.ekatvamacademy.com/www.vlearnclasses.com



## Sec 193 TDS On Interest On Securities

<b>Payer [Deductor]</b>	Any person
<b>Payee [Deductee]</b>	Any person being Resident
<b>Limit</b>	Company : If payment exceeds ₹5,000 Local Authority or : If payment exceeds ₹10,000 corporation/ 7.75% savings (Taxable) Bonds '18
<b>Rate</b>	10%
<b>Time of Deduction</b>	At the time of credit or payment whichever is earlier
<b>Special points</b>	<p><b>No TDS of Following :</b></p> <ul style="list-style-type: none"> <li>&gt; Interest payable to LIC/GIC or other insurer</li> <li>&gt; Interest on Provident Fund</li> <li>&gt; Any interest payable on any security issued by a co, where such security is in dematerialized form &amp; is listed on a recognised stock exchange in India,</li> <li>&gt; Interest payable on any security of the Central or State Govt, However, as per Finance Act, 2018 TDS shall be deducted on 7.75% Savings (Taxable) Bonds, 2018,</li> <li>&gt; Any interest payable to any insurance company in respect of any securities owned by it/in which it has full beneficial interest,</li> <li>&gt; "Indian Railway Finance Corporation Ltd, 54EC CG Bond" &amp; "Power Finance Corporation Ltd, 54EC Capital Gains Bonds" [Not. 27/2018]</li> <li>&gt; Not. 05/2017 - Interest Income accrued to minor child where both parents have deceased shall be deducted &amp; reported against the PAN of minor</li> </ul> <p><b>Meaning of interest on securities [Sec 2(28B)]</b> Interest on securities means -</p> <ul style="list-style-type: none"> <li>(i) Interest on any security of the Central Government or a State Government</li> <li>(ii) Interest on debentures or other securities for money issued by or on behalf of a local authority or a company or a corporation established by a Central, State or Provincial Act. [FA 2023]</li> </ul>

## Sec 194N TDS On Withdrawal In Cash

<b>Payer [Deductor]</b>	Every person, being,— (i) A banking company (ii) A co-operative society engaged in carrying on the business of banking; or (iii) A post office,						
<b>Payee [Deductee]</b>	Any person						
<b>Limit</b>	<p>1. Withdrawal exceeding 1cr during PY from one or more accounts maintained by the recipient shall at the time of payment deduct TDS @ 2% of such sum. <b>However, if the recipient is a co-operative society, tax is required to be deducted on any sum exceeding ₹ 3 crore. [FA 2023]</b></p> <p>2. In case of a recipient who has not filed the returns of income for all of the 3 A.Ys relevant to the 3 P.Y, for which the time limit of filing ROI u/s 139(1) has expired, then TDS shall be deducted as under</p> <table border="0"> <tr> <td>Amount or aggregate</td> <td>Rate of TDS</td> </tr> <tr> <td>Exceed 20L</td> <td>2% on sum exceeding 20L</td> </tr> <tr> <td>Exceeding 1 crore</td> <td>5% on sum exceeding 1 crore</td> </tr> </table> <p>CG may provide relaxation from application of this section if conditions are satisfied.</p>	Amount or aggregate	Rate of TDS	Exceed 20L	2% on sum exceeding 20L	Exceeding 1 crore	5% on sum exceeding 1 crore
Amount or aggregate	Rate of TDS						
Exceed 20L	2% on sum exceeding 20L						
Exceeding 1 crore	5% on sum exceeding 1 crore						
<b>Time of Deduction</b>	Deduction is to be made at the time of payment of such sum						
<b>Special Points</b>	<p><b>NO TDS shall be made if Payee is</b></p> <ol style="list-style-type: none"> <li>1. Government</li> <li>2. Bank, Co-op Bank or Post Office.</li> <li>3. Business correspondent of Bank or co-op Bank</li> <li>4. White label ATM operator</li> </ol>						

## Sec 194R TDS on Benefit & Perquisite in respect of Business or Profession w.e.f 1/4/22

<b>Payer [Deductor]</b>	<b>Specified Person</b> responsible for paying any sum				
<b>Payee [Deductee]</b>	Any person being Resident				
<b>Limit</b>	Amount exceeding 20000 p.a.				
<b>Rate</b>	10% of the value or aggregate of value of such benefit or perquisite:				
<b>Time of Deduction</b>	Before providing such benefit or perquisite				
<b>Special points</b>	<ol style="list-style-type: none"> <li>1. Payment shall be for any benefit or perquisite, whether convertible into money or not, arising from business or the exercise of a profession</li> <li>2. In case where the benefit or perquisite is wholly in kind or partly in cash and partly in kind but such part in cash is not sufficient to meet the liability of TDS in respect of whole of such benefit or perquisite, deductor shall, before releasing the benefit or perquisite, ensure that TDS required to be deducted has been paid.</li> </ol>				
	<p><b>3. Specified Person</b></p> <table border="1"> <tr> <td>Individual Or HUF</td> <td><b>Two Conditions must be satisfied :</b> 1. Turnover in Case of Business Exceed 1 Crore or Gross Receipt in case of Profession exceed 50L in PPY &amp; 2. In the PY payment for contract must exceed prescribe Limit.</td> </tr> <tr> <td>For Other Payee</td> <td>In the PY payment for contract must exceed prescribe Limit.</td> </tr> </table> <p>4. The following are some of the common examples of benefits and perquisites;  <ul style="list-style-type: none"> <li>• Gift Card and Gift Vouchers</li> <li>• Gold Coins under Incentive Scheme</li> <li>• Phones</li> <li>• Vehicles</li> <li>• Business Asset Usage Service</li> <li>• Travel Packages</li> </ul> </p> <p>5. Such gifts, perks or benefits provided on some special occasions like festivals, marriage occasions, etc. may not liable for TDS as Section cover only those benefits which arise out of business or profession.</p> <p><b>Example:</b> Mr. Aakash is a businessman engaged in trading of electronic items. Mr. Aakash requests samsung Ltd for giving a discount in his purchases. But instead of giving a discount company sponsors the 5-star hotel accommodation and conveyance of Aakash and also gift him a Rolex watch, in order to develop friendly business relations worth Rs. 2 Lakh. Now TDS will be deducted by Company @10% on 2L i.e. value of benefit or Perquisite.</p>	Individual Or HUF	<b>Two Conditions must be satisfied :</b> 1. Turnover in Case of Business Exceed 1 Crore or Gross Receipt in case of Profession exceed 50L in PPY & 2. In the PY payment for contract must exceed prescribe Limit.	For Other Payee	In the PY payment for contract must exceed prescribe Limit.
Individual Or HUF	<b>Two Conditions must be satisfied :</b> 1. Turnover in Case of Business Exceed 1 Crore or Gross Receipt in case of Profession exceed 50L in PPY & 2. In the PY payment for contract must exceed prescribe Limit.				
For Other Payee	In the PY payment for contract must exceed prescribe Limit.				

## Sec 194Q TDS on Purchase of Goods With effect from 01.07.2021

<b>Payer</b>	Buyer whose turnover or gross receipt exceed 10 Crore during PPY
<b>Payee</b>	Seller Resident who sell the good of value which exceeding Rs 50 Lakh
<b>TDS Rate</b>	0.1 % of sum exceeding Rs 50 Lakh
<b>Other Point</b>	<ol style="list-style-type: none"> <li>1) Sec 194Q applies to purchase of all goods whether on Capital or on revenue account.</li> <li>2) Sec is applicable whether Buyer is Resident or NR.</li> <li>3) If the Resident seller has not Provided Permanent account Number (PAN) or aadhar Number to the buyer, Then the TDS Would be deducted at 5% instead of 0.1%</li> <li>4) If TDS is deducted under this Section TCS u/s 206C(1H) is not Applicable.</li> <li>5) If TDS is deducted u/s 194-O then TDS under 194-Q is not applicable further if both section are applicable TDS under 190-O is applicable.</li> <li>6) If TDS under 194-O &amp; TCS u/s 206C(1H) is applicable then TDS under 194-O shall be applicable.</li> <li>7) The limit of Rs 50 Lakh shall be counted from 01.04.2021.</li> <li>8) In case of a transaction to which both sec 206(1H) and sec 194Q applies, tax is required to be deducted u/s 194Q.</li> <li>9) <b>Other points :</b> Where the sum is credited to any account, whether called "Suspense account" or by any other name, in the books of account of the person liable to pay such income, such crediting shall be deemed to be credit to the account of the payee for the purposes of this sec. Where the benefit or perquisite is wholly in kind or partly in cash and partly in kind but the part in cash is not sufficient to meet the liability of deduction of tax in respect of whole of such benefit or perquisite, the person responsible for providing such benefit or perquisite shall, before releasing the benefit or perquisite, ensure that tax has been paid in respect of the benefit or perquisite. [FA 2023]</li> </ol>



## Sec 192A TDS On Accumulated Balance On EPF

<b>Payer [Deductor]</b>	Trustee of EPF
<b>Payee[Deductee]</b>	Employee [R/NR]
<b>Limit</b>	If Amount exceed 50000
<b>Rate</b>	10%
<b>Time of Deduction</b>	At the time of payment

### Other Points :

- i. Exemption from TDS :
  - i. Withdrawal after continuous service of 5 years
  - ii. In case of withdrawal before continuous service of 5 years and –
    - (a) Employee opts for transfer of accumulated balance to the new employer
    - (b) Termination is due to ill health, contraction or discontinuance of business, cessation of employment etc. [FA 2023]

## Sec 192 TDS On Salary

<b>Payer [Deductor]</b>	Employer
<b>Payee[Deductee]</b>	Employee [R/NR]
<b>Limit</b>	If Annual Salary [after dedn & exemption.] exceed Basic Limit
<b>Rate</b>	Normal Slab rate calculation along with Cess [at the avg rate of income tax computed on basis of rates in force for FY in which the payment is made, on the estimated income of the assessee under this head for that FY
<b>Time of Deduction</b>	At the time of payment <ol style="list-style-type: none"> <li>(i) Such income-tax has to be calculated at the average rate of income-tax computed on the basis of the rates in force for the relevant financial year in which the payment is made, on the estimated total income of the assessee where the employee intimates to the employer his intent to exercise the option of shifting out of the default tax regime provided u/s 115BAC(1A)</li> <li>(ii) Average rate of income-tax means the rate arrived at by dividing the amount of income-tax calculated on the total income, by such total income</li> </ol>
<b>Manner of deduction of tax</b>	

- (iii) A deductor, being an employer, has to seek information from each of its employees having income u/s 192 regarding their intended tax regime and each such employee would intimate the same to the deductor; being his employer, regarding his intended tax regime for each year and upon intimation, the deductor has to compute his total income, and deduct tax at source thereon according to the option exercised. If intimation is not made by the employee, it would be presumed that the employee continues to be in the default tax regime u/s 115BAC and has not exercised the option to opt out of the default tax regime. Accordingly, in such a case, the employer has to deduct tax at source, on income u/s 192, in accordance with the rates provided u/s 115BAC(1A). It is also clarified that the intimation would not amount to exercising option u/s 115BAC(6) and the person shall be required to do so separately in accordance with the provisions of that section [Circular No. 4/2023 dated 5.4.2023].
- (iv) The concept of payment of tax on non-monetary perquisites has been provided in sec 192(1A) and (1B). These sections provide that the employer may pay this tax, at his option, in lieu of deduction of tax at source from salary payable to the employee. Such tax will have to be worked out at the average rate applicable to aggregate salary income of the employee and payment of tax will have to be made every month along with tax deducted at source on monetary payment of salary, allowances etc. [FA 2023]

**Sec 192(1A)-** TDS on perquisite Employer providing perquisite referred u/s 17(2), may pay, at his option, tax on the whole or part perquisite without any deduction therefrom at the time of deducting TDS.

**Sec 192(1C)-** TDS by an Employer being an eligible start-up (referred u/s 80-IAC) Providing specified securities in any year after 1/4/2021 TDS shall deduct & paid as under

1. 14 days After the expiry of 49 months from the end of the relevant AY; or
2. 14 days From the date of the sale of such specified security or sweat equity shares.
3. 14 days From the date of the assessee ceasing to be the employee. Whichever is the earliest, on the basis of rates in force for the FY in which the said specified security or sweat equity share is allotted or transferred.

### Special Points

TDS  
13.14

**Sec. 192(2)**- Where assessee is employed with more than one employer, he may furnish to details to one of the said employers as the assessee may choose, and thereupon such person shall take into account the details so furnished and deduct TDS accordingly.

**Sec. 192(2B)**- Assessee shall provide details of Other Income & loss if any under House Property to employer. The Employer upon receipt of such Income (or Loss) compute the TDS deductible.

**Sec. 192(2C)**- Employer shall furnish to employee a statement giving correct & complete particulars of perqs/profits in lieu of salary provided to him and the value thereof in such form and manner as may be prescribed.

**Sec. 192(2D)**- Employer shall for estimating income of the assessee or computing tax deductible obtain from the assessee the evidence or proof or particulars of prescribed claims (including claim for set-off of loss) under the provisions of the Act in such form & manner as may be prescribed.

## Sec 194P TDS on Pension [FA 2023]

<b>Payer [Deductor]</b>	Notified specified bank (a banking company which is a scheduled bank and has been appointed as agents of RBI u/s 45 of the RBI Act, 1934)
<b>Payee [Deductee]</b>	Specified senior citizen
<b>Limit</b>	Basic exemption limit [3,00,000 (in case the specified senior citizen pays tax under the default tax regime u/s 115BAC), 3,00,000/5,00,000, as the case may be, if the specified senior citizen has exercised the option of shifting out of the default tax regime providing u/s 115BAC] [i.e., total income after giving effect to the deduction allowable under Chapter VI-A, if any allowable should exceed the basic exemption limit. Further, in case the individual is entitled to rebate u/s 87A from tax payable, then the same should be given effect to]
<b>Rate</b>	Rates in force, where the individual has exercised the option of shifting out of the default tax
<b>Other relevant points</b>	Specified senior citizen means an individual, being a resident in India, who – - Is of the age of 75 years or more at any time during the P.Y.; - Is having pension income and no other income except interest income received or receivable from any account maintained by such individual in the same specified bank in which he is receiving his pension income; and

- Has furnished a declaration to the specified bank.  
Specified bank to compute the total income for the relevant A.Y. of the specified senior citizen who furnishes declaration in prescribed form, and deduct income-tax, after giving effect to deduction under Chapter VI-A, if any allowable (on the basis of evidence furnished by the specified senior citizen) and rebate allowable u/s 87A. [CBDT Notification No. 99/2021 dated 2.9.2021]  
The provisions of section 139, relating to filing of return, would not apply to a specified senior citizen for the A.Y. relevant to the P.Y. in which tax has been deducted u/s 194P(1).

## Tax Collected At Source

<b>Who is responsible</b>	<b>Seller collects it from Buyer Seller include:</b> <ul style="list-style-type: none"> <li>• CG/SG/LA</li> <li>• Company</li> <li>• Firm/LLP</li> <li>• Individual liable to Tax audit u/s 44AB</li> </ul> <b>Buyer Include every person other than</b> <ul style="list-style-type: none"> <li>• Public sector co</li> <li>• CG/SG/LA</li> <li>• Club</li> <li>• Buyer in Retail sale of such goods for personal consumption</li> </ul>
<b>Due date (Deposit)</b>	Deposited on last day of month in which goods are sold
<b>Issue of TCS Certificate</b>	Seller shall issue TCS certificate within month from date in which TCS was collected in form 2717
<b>Filing quarterly return by seller</b>	In form 27EQ on 15th July, Sep, Jan, April

## Sec 206CC TCS at Higher Rate

Any person whose payments are subject to TCS shall mandatorily furnish his PAN to the collector failing which the collector shall collect tax at source at higher of the following rates –

- At twice the applicable rate of TCS or
- At the rate of 5%

**However, the maximum the rate of TCS under this section shall not exceed 20%. [FA 2023]** The provisions of this section shall not apply to a non-resident who does not have permanent establishment in India.

TDS  
13.15

CA CS VIJAY SARDA  +91 89566651954

www.ekatvamacademy.com/ www.vlearnclasses.com



## Sec 206CCA TCS at Higher Rate

- > Sections is with effect from 01-July-2021.
- > Where TCS is required to be collected on any amount from the Specified person tax shall be collected at **higher rate of**
  - a) Twice the rate in Act
  - b) 5%
- However, the maximum the rate of TCS under this section shall not exceed 20%. [FA 2023]
- > If both Sec 206CC & 206CCA strikes then Amount shall be higher of either of the sections

“Specified Person” means:

1. A person who has not filed the ROI for both of the 2 PY who has not furnished ROI for the AY relevant to the PY immediately preceding the financial year in which tax is required to be deducted, for which the time limit for furnishing ROI has expired and the aggregate of TDS/TCS in his case is rupees 50000 or more in the said previous year.
2. The total amount of TDS and TCS in case of such person is ₹ 50,000 or more in each of these two previous years.

## Sec 206C TCS Provisions

**Sec 206C(1)- TCS on Alcohol/Timber/Scrap/Mineral:** Every person, being a seller shall, at the time of debiting of the amount payable by the buyer or at the time of receipt of such amount, whichever is earlier, collect from the buyer of any goods of the nature specified, a sum equal to the %, specified.

Sale Transaction	Rate
Alcoholic liquor for human Consumption	1%
Tendu leaves	5%
Timber obtained under forest lease	2.5%
Timber obtained by any mode other than a forest lease	2.5%
Any other forest produce not being timber or tendu leaves	2.5%
Scrap	1%
Minerals, being coal or lignite or iron ore	1%

Sale Transaction	Rates
Parking lot	2%
Toll plaza	2%
Mining & Quarrying	2%

**# Non-applicability of TCS u/s 206C(1) [Sec 206C(1A)] [FA 2023]**  
No collection of tax shall be made u/s 206C(1), in the case of a resident buyer, if such buyer furnishes to the person responsible for collecting tax, a declaration in writing in duplicate in the prescribed form and verified in the prescribed manner to the effect that goods referred to in sec 206C(1) above are to be utilised for the purpose of manufacturing, processing or producing articles or things or for the purposes of generation of power and not for trading purposes.

**Sec 206C(1A)(1B): NO TCS if Goods used for Manufacturing or Power Generation:** No TCS shall be made if such buyer furnishes a Declaration to PCCIT/CCIT/PCIT/CIT in writing in prescribed form to the effect that the goods referred above are to be utilized for :

1. Manufacturing, processing or producing articles or things or
2. For the purposes of generation of power and not for trading purposes.

**Sec 206C(1C) : TCS on Parking/Toll/Mining Rights :** Every person, who grants a lease or a licence or any right in whole or in part in any parking lot or toll plaza or mine or quarry, shall at the time of receipt of such amount from the licensee or lessee in cash or by Prescribe mode whichever is earlier, collect from the licensee or lessee TCS as under: Parking lot - 2%, Toll plaza - 2%. Mining and quarrying- 2% "mining and quarrying" shall not include mining and quarrying of mineral oil & "Mineral oil" includes petroleum and natural gas.

**Sec 206C(1F):** TCS on motor Vehicle Every person, being a seller, who receives any amount as consideration for sale of a motor vehicle of the value exceeding 10 lakh rupees, shall, at the time of receipt of such amount, collect from the buyer, a sum equal to 1% of the sale consideration as income-tax.

**Sec 206C(1G) - TCS on Foreign Remittance & Foreign Tour Package Remittance under LRS of RBI through an authorized dealer or purchase of an overseas tour package :**

Section 206C(1G) provides for collection of tax by every person, - Being an authorized dealer, who receives amount, under the Liberalized Remittance Scheme of the RBI, for remittance from a buyer, being a person remitting such amount; - Being a seller of an overseas tour programme package who receives any amount from the buyer who purchases the package. Tax has to be collected at the time of debiting the amount payable by the buyer or at the time of receipt of such amount from the said buyer, by any mode, whichever is earlier.

**Rate of TCS in case of collection by an authorized dealer/seller of an overseas tour programme package**

Sr No.	Amount and purpose of remittance	Rate of TCS upto 30.9.2023	Rate of TCS on or after 1.10.2023
(i)	Where the amount is for purchase of an overseas tour programme package	5% of such amount (without any threshold limit)	
(ii)	(a) Where the amount is remitted for the purpose of education or medical treatment; and (b) The amount or aggregate of the amounts being remitted by a buyer is less than ₹ 7 lakhs in a F.Y.	Nil (No tax to be collected at source)	
(iii)	(a) Where the amount is remitted for the purpose other than mentioned in (ii) above; and (b) The amount or aggregate of the amounts being remitted by a buyer is less than ₹ 7 lakhs in a F.Y.	Nil (No tax to be collected at source)	
(iv)	(a) Where the amount is remitted for the purpose of education or medical treatment; and (b) The amount or aggregate of the amounts in excess of ₹ 7 lakhs is remitted by the buyer in a F.Y.	5% of the amt or agg. of amts in excess of ₹ 7 lakh)	

TDS  
13.17

CA CS VIJAY SARDA +91 8956651954

(v)	(a) Where the amount is remitted for the purpose other than mentioned in (iv) above; and (b) The amount or aggregate of the amounts in excess of ₹ 7 lakhs is remitted by the buyer in a F.Y.	5% of the amt or agg. of amts in excess of ₹ 7 lakh	20% of the amt or agg. of amts in excess of ₹ 7 lakh
(vi)	(a) Where the amount being remitted out is a loan obtained from any financial institution as defined in sec 80E, for the purpose of pursuing any education; and (b) The amount or aggregate of the amounts in excess of ₹ 7 lakhs is remitted by the buyer in a F.Y.	0.5% of the amt or agg. of amts in excess of ₹ 7 lakh	

**No TCS Where:**

- (i) It is subject to TDS
- (ii) Where buyer to CG, a SG, an embassy, a High Commission, a legation, commission, a consulate, the trade representation of a foreign State, local authority or any other person as CG.

**Sec 206C(1H) - on Sale of Goods**

- > Every person, being a seller, who receives any amount as consideration for sale of any goods of the value or aggregate of such value exceeding 50 lakhs in any PY, other than the goods being exported out of India or goods covered in sub-sec (1) / (1F) / (1G) shall, at the time of receipt of such amount, collect from the buyer, a sum equal to 0.1% of the sale consideration exceeding 50 lakhs as income-tax
- > Provided that if the buyer has not provided the PAN or the Aadhaar no. to the seller, then the provisions of sec 206CC(1)(ii) shall be read as if for the words "5%", the words "1%" had been substituted.
- > If TDS is Attracted then no TCS.

www.ekatvamacademy.com/www.vlearnclasses.com



**Sec 206C(3)-Due date of Payment & Furnishing ROI (Rule 37CA):**

All sums collected u/s 206C shall be deposited to CG as under:

On the same day	Where the tax is so paid without production of an income tax challan
In or before 7 days from the end of the month in which the collection is made	Where tax is paid accompanied by an income tax challan.

- # If the buyer under this section has not provided the PAN or the Aadhaar to the seller, then TCS u/s 206CC shall be 1% instead of 5%.  
 # Provisions of this sub-section shall not apply if TDS is deducted.

**Explanation :**

- "Seller" means a person whose total sales, gross receipts or turnover from the business carried on by him exceed 10 Cr. During Previous year prior to PY in which the sale is made.
- "Buyer" means a person who purchases any goods but buyer does not include
  - The Central Government, a State Government, an embassy, a High Commission, legation, commission, consulate and the trade representation of a foreign State; or
  - A local authority
  - A person importing goods into India or any other person as the CG may, specify for this purpose & subject to such conditions as may be specified therein;

**(3A) Due date of TCS Return shall be furnished-**

- On or before the 30th day of April, where the statement relates to the month of March; and
- In any other case, on or before 15 days from the end of relevant month

**Sec 206C(3B)-Rectification of TCS Return:**

A correction statement for rectification of any mistake or to add, delete or update the information furnished can be filled by Assessee within prescribe Time.

**Sec 206C(4)-Credit of TCS Collected:**

Any amount collected and paid to CG shall be deemed to be a payment of tax on behalf of the person from whom the amount has been collected and such person shall claim the TCS credit while computing his Tax Liability.

**Sec 206C(5)- TCS Certified:**

Every person collecting tax shall furnish TCS Collection Certificate within 15 days from the due date for furnishing the statement of tax collected at source.

**Sec 206C(5D)-Communication of Defect in TCS Return:**

Where the Assessing Officer considers that the return delivered is defective, he may intimate the defect to the person collecting tax and give him an opportunity of rectifying the defect within a period of 15 days from the date of such intimation or within such further period which on an application made in this behalf. If the defect is not rectified it shall be treated as Invalid Return.

**Sec 206(6A) Treated as Assessee in Default:**

If any person responsible for collecting TCS does not collect the whole or any part of the tax or after collecting, fails to pay the tax he may be deemed to be an assessee in default in respect of the Tax. Any person responsible for collecting TCS shall not be deemed to be an assessee in default in respect of such tax if such buyer or licensee or lessee-

- Has furnished his return of income under section 139;
- Has taken into account such amount for computing income in such return of income; and
- The person furnishes a certificate to this effect from an accountant in such form as may be prescribed.

**Sec 206C(7) Interest for default:**

If the person responsible for collecting TCS does not collect the tax or after collecting the tax fails to pay he shall be liable to pay simple interest at the rate of 1% per month or part thereof on the amount of such TCS from the date on which such TCS was collectible to the date on which the tax was actually paid and such interest shall be paid before furnishing the quarterly statement for each quarter where an order is made by the Assessing Officer for the default under sub-section (6A), the interest shall be paid by the person in accordance with such order.

**Sec 206C(9) Certificate of Lower collection or no Collection :**

Lower collection certificate can be issued by AO to "seller" u/s 206C(1)/(1F)

TDS  
13.18

CA CS VIJAY SARDA  +91 895665 1954

[www.ekatvacademy.com/www.vlearnclasses.com](http://www.ekatvacademy.com/www.vlearnclasses.com)

## Unsolved Questions

### P.1 Based on sec 194I :

TDS Liability in this case

Date	Payment
10.10.2023	Rent paid for hire of machinery by B Ltd. to Mr. Raman ₹2.1L
31.12.2023	Fee paid to Dr. Srivatsan by Sundar (HUF) ₹35,000 for surgery performed to a member of the family
01.01.2024	ABC and Co. Ltd. paid ₹19,000 to one of its Directors as sitting fees
01.02.2024	Mr. X sold his house to Mr. Y on 01-02-2023 for ₹60 lacs?
01.03.2024	Winning by way of jackpot in a horse race ₹1L
01.07.2023	Rent paid for plant and machinery ₹1.5L by a partnership firm having sales turnover of ₹20L & net loss of ₹15,000.

### P.2 Based on sec 194C, 194BB, 194LA

State in Brief the applicability of TDS Provisions

Particulars	₹
Winning from jackpot in horse races	1,00,000
Payment made by firm to sub contractor Rs.3L with o/s balance of Rs.1.2L shown in the books as on 31.3.24	4,20,000
Rent paid for P&M by a partnership firm having sales turnover of Rs.20L and net loss of Rs.15000	1,50,000
Payment made to ricky ponting an NR for contribution in article	25,000

### P.3 Based on sec 194IB

Mr. X, a salaried individual, pays rent of ₹55,000 per month to Mr. Y from June, 2023. Is he required to deduct tax at source? If so, when is he required to deduct tax? Also, compute the amount of tax to be deducted at source. Would your answer change if Mr. X vacated the premises on 31st December, 2023? Also, what would be your answer if Mr. Y does not provide his PAN to Mr. X?

### P.4 Based on sec 194M, 194C, 194H

Examine whether TDS provisions would be attracted in the following cases, and if so, under which sec also specify the rate of TDS applicable in each case. Assume that all payments are made to residents.

Particulars of the payer	Nature of payment	Aggregate of payments made in the F.Y. 2023-24
Mr. Ganesh, an individual carrying on retail business with turnover of ₹2.5 cr in the P.Y.2022-23	Contract Payment for repair of residential house	₹5 lakhs
Mr. Rajesh, a wholesale trader whose turnover was ₹35 lakhs in P.Y. 2022-23.	Payment of commission to Mr. Vallish for business purposes	₹80,000
Mr. Satish, a salaried individual	Contract Payment for reconstruction of residential house (made during the period January- March, 2024)	₹20 lakhs in Jan, 2024, ₹15 lakhs in Feb 2024 and ₹20 lakhs in Mar 2024.
Mr. Dheeraj, a pensioner	Payment of brokerage for buying a residential house in March, 2024	₹51 lakhs
	Contract payment made during October-November 2023 for reconstruction of residential house	₹48 lakhs

### P.5 Based on sec 194 DA + Exemption u/s 10(10D)

Examine the applicability of the provisions for tax deduction at source under section 194DA in the following cases -

- Mr. X, a resident, is due to receive ₹4.50 lakhs on 31.3.2024, towards maturity proceeds of LIC policy taken on 1.4.2021, for which the sum assured is ₹4 lakhs and the annual premium is ₹1,25,000.
- Mr. Y, a resident, is due to receive ₹3.95 lakhs on 31.3.2024 on LIC policy taken on 31.3.2012, for which the sum assured is ₹3.50 lakhs and the annual premium is ₹26,100.
- Mr. Z, a resident, is due to receive ₹95,000 on 1.8.2023 towards maturity proceeds of LIC policy taken on 1.8.2017 for which the sum assured is ₹90,000 and the annual premium was ₹10,000.



Sr No.	Particulars	Pg No
1	Sec 208 Conditions of Liability to pay Advance Tax	14.2
2	Sec 207 Liability for payment of advance tax	14.2
3	Sec 209 Computation of advance tax	14.2
4	Sec 211 Due dates for payment of advance tax other than persons covered u/s 44AD/ADA	14.2
5	Sec 218 When Assessee deemed to be in default	14.2
6	Proviso to Sec 234 Payment of advance tax in case of capital gain & casual income	14.3
7	Sec 234B Interest for default in payment of advance tax	14.3
8	Sec 234C Interest for deferment of advance tax	14.4
9	Unsolved Questions	14.4

“  
**Working on  
MYSELF  
FOR MYSELF,  
BY MYSELF**  
”



## Sec 208 Conditions of Liability to Pay Advance Tax

Advance tax shall be payable during a financial year in every case where the amount of such tax payable by the assessee during that year, as computed in accordance with the provisions of this Chapter, is Rs. 10,000 or more. Assessee who is covered u/s 44AD/44ADA is also liable to pay advance Tax.

## Sec 207 Liability For Payment of Advance Tax

<b>Individual resident</b>	1. There is no Income chargeable under the head PGBP
<b>Other</b>	2. The assessee is aged 60 years or more at any time during PY Total Advance Tax Payable is less than 10,000 (Sec 208)

## Sec 209 Computation of Advance Tax

Particulars	Amt.
Income under the 5 heads of income	xxx
Adjustment in respect of B/F loss and allowance	xxx
<b>GROSS TOTAL INCOME</b>	<b>XXX</b>
<b>Less:</b> Deduction admissible under Chapter VI-A	<b>(xxx)</b>
<b>TAXABLE INCOME</b>	<b>XXX</b>
Tax on Taxable Income	xxx
<b>Less:</b> Rebate u/s 87A	<b>(xxx)</b>
<b>TAX PAYABLE</b>	<b>XXX</b>
<b>Add:</b> Surcharge	xxx
<b>NET TAX PAYABLE</b>	<b>XXX</b>
<b>Less:</b> Relief under Sec. 89, 90, 90A, 91	<b>(xxx)</b>
Tax liability	xxx
<b>Less:</b> TDS/TCS	<b>(xxx)</b>
<b>Less:</b> MAT/AMT Credit u/s 115JAA	<b>(xxx)</b>
<b>ADVANCE TAX</b>	<b>XXX</b>

AT  
14.2

## Sec 211 Due Dates For Payment of Advance Tax Other Than Persons Covered u/s 44AD/ADA

Due date of Installments	On or before Companies & Other assessee
15th June	Not less than 15% of Adv. Tax liability
15th Sept	Not less than 45% of Adv.
15th Dec.	Not less than 75% of Adv.
15th March	The whole amt. of Adv.

### Notes:

- Person covered u/s 44AD/ADA to pay Advance Tax by 15th March.
- Any amount paid by way of advance tax on or before the 31st day of March shall also be treated as advance tax paid during the FY ending on that day for all the purposes of this Act.
- If due date for payment of any installment of AT is banking holiday, and payment is made on the next immediately following working days. No interest shall be leviable u/s 234B or 234C.
- While calculating advance tax, net agricultural income shall also be taken into consideration for computing tax liability.
- If any assessee does not pay any installment within due date he shall be deemed to be an assessee in default in respect of such installment (Sec 218).
- Advance Tax is deposited in Challan no.280.
- If the notice of demand issued u/s 156 in pursuance of an order of the AO u/s 210(3)/(4) is served after any of the due dates specified in sec 211(1), the appropriate part or, as the case may be, the whole of the amount of the advance tax specified in such notice shall be payable on or before each of such of those dates as fall after the date of service of notice of demand.

## Sec 218 When Assessee Deemed To Be In Default

If any person does not pay on the date specified in Sec 211(1), any installment of the advance tax that he is required to pay by an order of the AO u/s 210(3)/(4) & does not, on or before the date on which any such installment as it is not paid becomes due, send to the AO an intimation u/s 210(5) or does not pay on the basis of his estimate of his current income the advance tax payable by him u/s 210(6), he shall be deemed to be an assessee in default in respect of such installment(s).



## Proviso Sec 234 Payment of Advance Tax In Case of Capital Gain & Casual Income

1. Advance tax is payable on all types of income, including capital gains and winnings of lotteries, crossword puzzles, etc.
2. However, it is not normally possible for an assessee to estimate his capital gains or winnings from lotteries, etc. which are generally unexpected. Therefore, it is provided that if any such income arises after the due date of any installment, then, the entire amount of tax payable (after deduction of tax at source, if any) on such capital gain or casual income should be paid in remaining installments of advance tax which are due or where no such installment is due, by 31st March of the relevant Financial Year.
3. If the entire amount of tax payable is so paid, then no interest on late payment will be leviable.

## Sec 234B Interest For Default In Payment of Advance Tax

### Interest is payable if -

- a) Advance tax paid during PY < 90% of Assessed tax OR
- b) No advance tax paid during the year

### Assessed tax Means:

- a. **Where NO Assessment is made:** Tax on Income as per Summary Assessment u/s 143(1)
- b. **Where Regular Assessment is made:** Tax on the total income determined under such regular assessment As Reduced By: Relief u/s 89,90,91(DTAA), TDS/TCS credit, Advance Tax Paid, MAT or AMT Credits u/s 115JD, in case the assessee exercises the option of shifting out of the default tax regime provided under section 115BAC(1A) [FA 2023].

## Where no Tax Paid After 31st March of the PY u/s 140A or Otherwise:

Advance Tax short as per ROI	X	1% per month or part of a month	X	Commences from 1st April of AY & ends on date of filing of ROI
------------------------------	---	---------------------------------	---	--

## Where Tax has been paid after 31st March of the PY u/s 140A or Otherwise:

Advance Tax short as per ROI	X	Rate	X	Period
		1% per month Simple Interest	Aggregate of	1% per month Simple Interest
		Commences from 1st April of AY & ends on date of payment of tax u/s 140A / otherwise		Commences from the date next following the date of payment of tax u/s 140A or otherwise & ends on date of filing of ROI.

Interest under this sec shall be reduced by interest, any paid u/s 140A or otherwise. If an assessment is cancelled & referred back to AO for fresh assessment, then interest under this sec shall be levied upto the date of completion of fresh assessment

### **Common Amendment in Sec 234A & 234B :**

- a) Tax on total income as determined u/s 143(1) shall not include the additional income-tax, if any, payable u/s 140B or section 143; and
- b) Tax on the total income determined under regular assessment shall not include the additional income-tax payable u/s 140B.

## Sec 234C Interest For Deferment of Advance Tax

Assessee to whom Sec 44AD/44ADA does not apply	Assessee to whom Sec 44AD/44ADA apply
<b>CHARGEABILITY</b>	
Interest is payable if : a) Advance tax paid on/before 15th June < 12% of "Tax due on returned income" AND / OR b) Advance Tax paid on/before 15th Sept < 36% of "Tax due on returned income" AND / OR c) Advance tax paid on/before 15th Dec < 75% of "Tax due on returned income" AND / OR d) Advance tax paid on/before 15th March < "Tax due on returned income" OR e) No advance tax paid.	Interest is payable if : Advance tax paid on/before 15th March < "Tax due on returned income"
<b>Tax due on Returned Income means tax on total income declared in ROI as reduced by :</b> i) Any tax deducted or collected at source as per Chap XVII on any income which is subject to deduction / collection & which is taken into account in computing such total income; ia) Any relief of tax allowed u/s 89; ii) Any relief of tax allowed u/s 90 on account of tax paid in a country outside India; iii) Any relief of tax allowed u/s 90A on account of tax paid in a specified territory outside India ref to in that section; iv) Any deduction, from the Indian income tax payable, allowed u/s 91, on a/c of tax paid in a country outside India & v) Any tax credit allowed to be set off u/s 115JAA/JD.	

## COMPUTATION OF INTEREST

1.	Deferred Amount	Always Calculated on Tax as per ROI as reduced by Relief u/s 89/90/91 (DTAA), MAT/AMT credit, TDS & TCS. <i>in case the assessee exercises the option of shifting out of the default tax regime provided u/s 115BAC(1A) [FA 2023]. [Refer Point D]</i>
2.	Rate	1% for every month or part of a month
3.	Period	Q1 / Q2 / Q3 - Interest for 3 months for all Installment. In case of last Quarter, Q4 Interest for 1 month shall be applicable.

## Unsolved Questions

### P.1 Based on Presumptive Income :

Mr. Narayan is engaged in retail business of groceries. During PY 23-24 his turnover was ₹ 1.65 cr. Out of this, receipt of ₹ 1.30 cr represents online transactions & ₹ 35L cash transactions. He opted for paying tax as per presumptive tax scheme laid down u/s 44AD. He has no other income during PY. Is he liable to pay advance tax & if so, what is the minimum amount of advance tax to be paid & the due date for payment of such advance tax?

AT  
14.4



## RETURN OF INCOME

Sr No.	Particulars	Pg No
1	Sec 139 Filing of ROI	15.2
2	Due date of Filing of ROI u/s 139(1)	15.2
3	Consequences of not filing return within due date u/s 139(1)	15.3
4	Sec 234F Fee for default in furnishing ROI	15.3
5	Sec 139(1A) Bulk Return	15.3
6	Sec 139(1C) CG to exempt class of persons	15.3
7	Sec 234A Interest on Default in Furnishing Return	15.3
8	Sec 139(3) Loss Return	15.4
9	Sec 139(4) Belated Return	15.4
10	Sec 139(5) Revised Return	15.4
11	Sec 139(9) Defective Return	15.4

Sr No.	Particulars	Pg No
12	Sec 139A Permanent Account Number	15.5
13	Sec 139AA Aadhaar Number	15.5
14	Rule 114AAA specifies the manner of making PAN number inoperative [FA 23]	15.6
15	Sec 140A Self Assessment Tax	15.6
16	Sec 139B Tax Return Preparers [TRP]	15.7
17	Sec 140 Who shall verify the Return	15.7
18	Sec 234H Fees for Default in Intimation of Aadhaar	15.8
19	Sec 139(8A) Updated Return	15.8
20	Sec 140B How to calculate tax on updated return	15.9
21	Unsolved Questions	15.10

### IMPORTANT AMENDMENTS/ NOTIFICATIONS/CIRCULARS

Sr No.	Particulars	Pg No
1	Filing of ROI	15.2
2	Sec 234A Interest	15.3
3	Sec 139(8A) Updated Return	15.8

ROI  
15.1

“  
TIME will PASS  
will you?  
”



## Sec 139 Filling Of ROI

### Every person, -

- (a) Being a company or a firm; or
- (b) Being a person other than a company or a firm, if his total income or the total income of any other person in respect of which he is assessable under this Act during the PY exceeded the maximum amount which is not chargeable to tax,
- (c) **Being ROR who at any time during PY,**
  - (a) Holds, as a beneficial owner or otherwise, any asset (incl. any financial interest in any entity) located outside India or has signing authority in any account located outside India; or
  - (b) Is a beneficiary of any asset (including any financial interest in any entity) located outside India.
- (d) Being an individual/HUF or AOPs/BOIs, whether incorporated or not, or an AJP,
  - > If his total income or total income of any other person in respect of which he is assessable under this Act during PY, without giving effect to the provisions of Sec 10(38)/10A/10B/10BA/54/54B/54D/54EC/54F/54G/54GA/54GB/Chapter VI-A exceeded max amount which is not chargeable to IT.

### (e) A person:

1. Has deposited an amount or aggregate of the amounts exceeding 1 cr rupees in one or more current accounts maintained with a banking company or a co-operative bank;
2. Has incurred expenditure of an amount or aggregate of amounts exceeding 2 lakh rupees for himself any other person for travel to a foreign country;
3. Has incurred expenditure of an amount or aggregate of the amounts exceeding one lakh rupees towards consumption of electricity;
4. Fulfills such other conditions as may be prescribed.
  - > Furnish a return of his the income of such other person during the PY, in the prescribed form & verified in the prescribed manner & setting forth such other particulars as may be prescribed.

### f) Following Person also required to file ROI

Case	Prescribed transactions	Prescribed Monetary Threshold
(1) (2)	(3)	(4)
(i) A person carrying on business	His total sales, turnover or gross receipts, as the case may be, in the business	> ₹ 60 lakhs during the relevant P.Y.
(ii) A person carrying on business	His total gross receipts in profession	> ₹ 10 lakhs during the relevant P.Y.
(iii) (a) A resident individual who is aged ≥ 60 yrs at any time during the relevant P.Y. (b) Any other person	The aggregate of TDS and TCS in his case	> ₹ 50,000 during the relevant P.Y.
(iv) A person having savings bank account	The aggregate of TDS and TCS in his case	> ₹ 25,000 during the relevant P.Y.
	The deposit in one or more savings bank account of the person, in aggregate	> ₹ 50 lakhs during the relevant P.Y.

## Due Date Of Filling ROI u/s 139(1)

<b>Company</b>	Liable to TP Report u/s 92E, partner of such Assessee & if covered by Sec 5A spouse of such partner	30th Nov of AY
<b>Others</b>	Liable to tax audit u/s 44AB, where assessee is a partner in a firm, whose accounts are required to be audited under any law or spouse of such partner if provision of section 5A applies to such spouse. <del>Spouse of Partner</del>	31st Oct of AY
	Others	31st July of AY



Sec 5A of Income Tax : Where the husband and wife are governed by Portuguese Civil Code of 1860 as "COMMUNIAO DOS BENS"), such income of the husband and of the wife under each head of income (other than under the head "Salaries") shall be apportioned equally between the husband and the wife and the income so apportioned shall be included separately in the total income of the husband and of the wife respectively and the remaining provisions of this Act shall apply accordingly.

### Consequences Of Not Filing Return Within Due Date u/s 139(1)

- > Interest u/s 234A
- > Fees u/s 234F
- > Benefit of carry forward of losses u/s 72/73/74/74A is lost
- > Right to revise the return of income u/s 139(5) is lost
- > Department action u/s 142(1) or 144 or 148
- > Prosecution u/s 276CC

### Fee For Default In Furnishing Return Of Income u/s 234F

Where a person required to furnish a ROI u/s 139, fails to do so within the time prescribed he shall pay, by way of fee, a sum of **Rs.5000**

### Sec 139(1A) Bulk Return

Specified Assessee[Salaried] can file their ROI to Employer and then employer shall furnish such ROI in Bulk in a PD or CD to Department.

### Sec 139(1C) CG To Exempt Class Of Persons

CG is Empowered to notify the class of person who will be exempted from requirement of Filing ROI

## Sec 234A Interest For Default In Furnishing Return

**Interest is payable if -**

- a) ROI is filed after the due date specified u/s 139(1)/139(4)/139(8A)/142(1) OR
- b) ROI is not filed

Commences from next day foll. due date u/s 139(1) & ends on :	
Tax on Income declared in ROI	1% per month or part of a month
X	X
ROI filed :	The date of filing of ROI
ROI not filed :	Date of completion of assessment u/s 144/147/153A

**\* Part of the month shall be considered as full month.**

Interest is calculated of the tax on total income as determined u/s 143(1), & where regular assessment is made, on the amount of tax on the total income determined under regular assessment, as reduced by -

- i) Advance tax paid, if any
- ii) Any tax deducted or collected at source;
- iii) Any relief of tax allowed u/s 89;
- iii) Any relief of tax allowed u/s 90 on account of tax paid in a country outside India;
- iv) Any relief of tax allowed u/s 90A on account of tax paid in a specified territory outside India ref to in that section;
- v) Any deduction, from the Indian income tax payable, allowed u/s 91, on a/c of tax paid in a country outside India &
- vi) Any tax credit allowed to be set off u/s 115JAA/JD.

**Dr. Pranoy Roy vs. CIT** - Credit allowed of Self Assessment Tax, if paid upto due date of return filing. Interest under this sec shall be reduced by interest, any paid u/s 140A or otherwise.

## Sec 139(3) Loss Return

If a person has sustained a loss under the head "Profits & gains of business or profession" or under the head "Capital Gains" & claims that such loss should be carried forward u/s 72/73/73A/74/74A, then he may furnish a return of loss within the time prescribed u/s 139(1) & all provisions of the Income-tax Act shall apply as if it were a return furnished u/s 139(1).

**East Asiatic Company India Private Limited (Mad.)**

Unabsorbed depreciation can be carried forward even if the ROI is furnished after the due date specified in section 139(1).

**CIT v. Haryana Hotels Ltd. (Punj. & Har.)**

Unabsorbed depreciation can be carried forward even if no return has been filed by the assessee.

## Sec 139(4) Belated Return

Any person who has not furnished a return within the time allowed to him u/s 139(1), may furnish the return for any PY at any time > 3 months before the end of relevant AY

OR

> Before completion of assessment, whichever is earlier.

## Sec 139(5) Revised Return

Return Filled u/s 139[1]/139[3]/139[4] can be revised if discover any omission or wrong statement in such ROI filed earlier > 3 months Before End of AY or

> Before Completion of Assessment Whichever is Earlier.

**Notes:**

1. Revised return replaces original return. [Dhampur Sugar Mills vs. CIT]
2. Return can be revised even after receiving intimation u/s 143[1] or refund.
3. No restriction on revision no of times.
4. OR/BR/LR/RR- all ROI can be Revised.

<b>Case: India Ltd. vs. CIT [SC]</b>	<b>Case:</b> A fresh claim before AO can be made by Filing Statement/ Letter?
	1- <b>Held:</b> NO, fresh claimed before AO can be made by Filing Revised Return.
	2- But a fresh claim before CIT[A] without a Revised Return is Possible. [Pruthvi brokers or Jute Corporation of India]
	3- But a fresh claim before ITAT without a Revised Return is Possible. [National Thermal Power Corp. [SC]]

## Sec 139(9) Defective Return

**ROI considered as defective Unless:**

- a) Column, Annexure, is duly filled
  - b) Proof of tax paid given
  - c) Audit report, if any submitted along with B/S and P&L.
- Rectify defect within time specified in Notice [generally 15 days]  
If return rectified & submitted - Valid Return  
If return not rectified - Invalid Return



## Sec 139A Permanent Account Number

### Following person must obtain PAN:

1. Every person liable to pay tax.
2. Person carrying PGBP having Sales/turnover exceeding ₹5L
3. Every person required to Furnish ROI u/s 139[4A]
4. Being Resident[other than Individual] which enters financial transaction in aggregate exceeding ₹2.5L or more in FY
5. Person who is MD, Director, trustee, Founder, karta, CEO, principal officer.

6. Who intends to enter into such transaction as may be prescribe by

Board :

- > Any person has not been allotted a PAN but possesses Aadhaar number, may furnish his Aadhaar number in lieu of PAN, & such person shall be allotted a PAN in such manner as may be prescribed; has been allotted a PAN, and who has intimated his Aadhaar number may furnish or intimate or quote his Aadhaar number in lieu of the PAN.
- > Every person entering into such transaction, as be prescribed, shall quote his PAN/Aadhaar number, as the case may be, in documents pertaining to such transactions & also authenticate such PAN or Aadhaar number, in such manner as be prescribed.
- > Every person receiving any document shall ensure that PAN or Aadhaar number, is so authenticated.

- > **Notification 31/2019** : Aadhaar must be intimated to prescribe authority [PDGIT (Systems)] by 31/03/2022
- > Further, every person who has not been allotted a PAN and intends to enter into such transaction as prescribed by the CBDT is also required to apply for PAN to the Assessing Officer. Accordingly, Rule 114BA has been inserted to prescribe the following transactions [FA 2023]:

Situation	Time Limit
Every person, if TI > BEL	On/before 31 may of AY
Person carrying business & sales exceed 5L	Before the end of that FY (PY)
Every person who is required to furnish ROI u/s 139(4A)	Before the end of that FY (PY)
Every person being a resident, other than an individual, which enters into a financial transaction of an amount aggregating to ₹2,50,000 or more in a FY	On or before 31 May of immediately following FY
Every person who is a managing director, partner, trustee, author, founder, karta, CEO, principal officer or office bearer	On or before 31 May of immediately following FY

## Sec 139AA Aadhaar Number

<b>Required Upon</b>	Every person who is eligible to obtain Aadhaar number shall, on or after the 1st day of July 2017 quote Aadhaar number - a) Pan Application b) Filling ROI
<b>If Don't possesses aadhaar</b>	Where the person does not possess the Aadhaar Number, Enrolment ID of Aadhaar application
<b>Non Compliance</b>	In case of failure to intimate Aadhaar number, PAN allotted shall be deemed to be <del>invalid</del> <b>inoperative (without declaring it invalid) (being confirmed by Binoy Viswam vs. U.I, 2017 (SC))</b> & other provisions shall apply as not applied PAN
<b>Sec not applicable to</b>	1) NR 2) Person having an age of 80 years or above 3) Person is not a citizen of India 4) Person residing in Assam, Meghalaya, J&K

## Rule 114AAA specifies the manner of making permanent account number inoperative [IA 2023]:

Sub-Rule	Provision
(1)	If a person, who has been allotted PAN as on 1st July, 2017 and is required to intimate his Aadhaar number under section 139AA(2), has failed to intimate the same on or before 31st March, 2022, the PAN of such person would become inoperative and he would be liable for payment of fee in accordance with sec 234H read with Rule 114(5A) i.e., ₹ 1,000.
(2)	Where such person who has not intimated his Aadhaar number on or before 31st March, 2022, has intimated his Aadhaar number u/s 139AA(2) after 31st March, 2022, after payment of fee specified in section 234H read with Rule 114(5A), his PAN would become operative within 30 days from the date of intimation of Aadhaar number.
(3)	A person, whose PAN has become inoperative, would be liable for following further consequences for the period commencing from the date as specified under (4) below till the date it becomes operative – (i) No refund of any amount of tax or part thereof, due under the provisions of the Act; (ii) Interest would not be payable on such refund for the period, beginning with the date specified under (4) below and ending with the date on which it becomes operative; (iii) Where tax is deductible at source in case of such person, such tax shall be deducted at higher rate, in accordance with provisions of section 206AA; (iv) Where tax is collectible at source in case of such person, such tax shall be collected at higher rate, in accordance with provisions of section 206CC.
(4)	The consequences in (3) above would be effective from the date specified by the Board i.e., 1.7.2023 [Circular No. 3/2023 dated 28th March, 2023]

## Sec 140A Self Assessment Tax

Where any tax & interest u/s 234A, 234B & 234C & fee u/s 234F is payable by the assessee on the basis of the return of income required to be furnished u/s 139 or sec 142(1)/sec 148, or sec 153A, after deducting:

- > Advance Tax;
- > Any tax deducted or collected at source;
- > **Any relief of tax claimed u/s 89;**
- > Any relief of tax claimed u/s 90 / 91 of tax paid in country o/s India;
- > Any relief of tax claimed u/s 90A on account of tax paid in any specified territory outside India referred to in that sec;
- > Any MAT credit u/s 115JAA or AMT credit u/s 115JD; and
- > Any tax or interest payable according to the provisions of sec 191(2)

### SIMPLIFIED ANALYSIS :

The Assessee is required to assess his own Income & Tax payable thereon after taking into account :

Total Income	XXX
Compute tax on total income	XXX
After surcharge & HEC	
Less: TDS/TCS/Advance tax	[xxx]
Relief 89/90/91/153AA/115JD	
<b>Add:</b> Interest u/s 234A/B/234F	XXX
Tax & Interest u/s 191(2)	
Final Advance Tax payable	XXX

The assessee shall be liable to pay such tax with interest & Fees. Where the amount paid by the assessee falls short of the aggregate of the tax the amount so paid shall first be adj towards the Fees & thereafter interest payable as aforesaid & the balance, if any, shall be adjusted towards tax payable.



## Notes :

### Consequences of Failure to Pay Tax Interest or Fees :

- A) Assessee shall deemed to be Assessee in Default & interest is payable u/s 220/221.
  - B) Recovery Proceeding shall be Initiated. However, ROI shall not be treated as defective, if SA is not paid
  - C) Penalty u/s 221 can also be levied – Maximum penalty = Tax in arrears.
- After a regular assessment any amount of Advance tax shall deemed to be paid towards regular Assessment.

## Sec 139B Tax Return Preparers [TRP]

A TRP is an individual who has been authorized to enable any specified class(s) of person to prepare & furnish their returns of income.

1. **Who can be TRP ?**
  - > Any Individual or HUF
2. **Person not eligible to become TRP :-**
  - > Chartered Accountant.
  - > Any legal practitioner who is entitled to practice in any civil court in India.
  - > An employee of the specified class / classes of person.
3. **Education & qualification of TRP :-**
  - > Graduate from recognize university/ Institution.
  - > Who have cleared intermediate exam of CA/CS/CMA Inst.
4. **Return which cannot be filled by TRP**
  - > Person covered under Tax Audit
  - > Revised return if original return is not made by TRP
  - > Person not resident In India

**Circular No 6/2019 :** Quoting Aadhaar is mandatory on all returns filed after 01/04/2019.

**Notification 31/2019 :** Aadhaar must be intimated to prescribe authority [PDGIT (Systems)] by **31/03/2022**

## Sec 140 Who shall Verify the Return

Assessee	Signatory/Verified by
<b>Individual</b>	<ol style="list-style-type: none"><li>1. <b>Present in India:</b> Assessee himself</li><li>2. <b>Absent from India:</b> Individual himself or person authorized by him</li><li>3. <b>Mentally Incapacitated:</b> Person competent to act on his behalf or legal guardian.</li><li>4. <b>Other cases:</b> Person duly authorize by him.</li></ol>
<b>HUF</b>	<ol style="list-style-type: none"><li>1. <b>General:</b> By Karta</li><li>2. Karta absent from India or is Mentally Incapacitated: Any other Adult Member of the family.</li></ol>
<b>Company</b>	<ol style="list-style-type: none"><li>1. <b>General:</b> By Managing Director</li><li>2. MD is not able to sign or there is no MD: Any other Director or any other person as may be prescribed</li><li>3. Co not Resident in India: Holder of a valid Power of Attorney</li><li>4. Company is in liquidation or Receiver is appointed the Liquidator</li><li>5. Management taken over by Government: Principal Officer</li></ol>
<b>Limited Liability Partnership</b>	<ol style="list-style-type: none"><li>1. <b>General:</b> By Designated partner</li><li>2. Designated Partner is not able to sign / no designated partner Designated Partner: Any other Partner. any other person as may be prescribed</li></ol>
<b>Local Authority</b>	Principal Officer
<b>Political Party</b>	Chief Executive Officer
<b>Association of Persons</b>	Any Member or Principal Officer
<b>Any Other Persons</b>	That person or any other person who is competent to sign on his behalf
<b>Insolvency is applied as</b>	Insolvency professional appointed by such Adjudicating Authority.

ROI  
15.7

CA CS VIJAY SARDA  +91 8956651954

www.ekatvamacademy.com/www.vlearnclasses.com

## Sec 234H Fees for Default in Intimation of Aadhaar

Where a person, who is required to intimate his Aadhaar Number u/s 139AA(2), fails to do so on or before the notified date i.e., 30th June, 2021, he shall be liable to pay such fee, as may be prescribed, at the time of making intimation under section 139AA(2) after 30th June, 2021. However, such fee shall not exceed Rs.1,000

## Sec 139(8A) Updated Return

# Any person may furnish an updated return of his income (or the income of any other person in respect of which he is assessable under the Act) for the previous year relevant to such AY. Applicable from 1-04-2022 -

# **Time-limit** - Updated return under section 139(8A) can be submitted at any time within 24 months from the end of the relevant AY. For instance, updated return for the AY 2022-23 can be submitted on or before March 31, 2025.

# Who can submit updated return - Updated return can be submitted by any person whether ((or not) he has furnished a return u/s 139(1)/(4(BR)))/(5(RR)) for an AY (herein referred to as the relevant A.Y.).

# **Other points - The following points should be noted -**

1. If a person has sustained a loss for any previous year and he has already submitted return of loss for that year within due date [as given in sec 139(1)], he can furnish an updated return for that year u/s 139(8A) where such return is a return of income. [A Loss return can be updated only with an updated return which reflects Inc]

Loss ROI	▶	Updated Loss Return	✘
Income ROI	▶	Updated Income Return	✔
Income Return	▶	Updated Loss Return	✘
Loss Return	▶	Updated Return Income	✔

2. If as a result of submitting updated return u/s 139(8A), the quantum of carried forward loss (or unabsorbed depreciation or MAT/ AMT credit) is to be reduced for any subsequent year, then an updated return shall be furnished for each such subsequent year.

# **When updated return cannot be submitted - In the following cases updated return cannot be submitted -**

1. If updated return is a return of a loss.
2. If updated return has the effect of decreasing the total tax liability determined on the basis of return furnished or results in refund or increases the refund due on the basis of return.
3. If Search has been initiated under section 132 or books, other documents or any assets are requisitioned u/s 132A or a survey has been conducted u/s 133A [other than Sec 133A (2) / 133A(5)].
4. A notice has been issued to the effect that any money, bullion, jewellery or valuable article or thing or Books or Documents, seized or requisitioned u/s 132 or sec. 132A in the case of any other person belongs to Assessee, or
5. Where an updated return has already been furnished by him u/s 139(8A) for the relevant AY. or
6. Any proceeding for assessment/reassessment/re-computation/revision of income is pending or has been completed for that AY
7. The AO has information in respect of such person for the relevant AY in his possession under :
  - a. The prevention of money Laundering Act 2002 or
  - b. The Black Money (undisclosed foreign income & Assets) and imposition of Tax Act or
  - c. The prohibition of Benami property transaction Act 1988 or
  - d. The Smugglers and Foreign Exchange Manipulators (Forfeiture of property) Act, 1976 and the same has been communicated to him, prior to the date of his filing of return u/s 139(8A), or
8. Information has been received under DTAA (sec 90 or 90A) in respect of such person and the same has been communicated to him, prior to the date of filing of return under section 139(8A), or
9. Any prosecution proceedings have been initiated for the relevant AY in respect of such person,
10. He is a person or belongs to a class of persons, as may be notified by the Board in this regard.

ROI  
15.8

CA CS VIJAY SARDA  +91 89566651954

[www.ekatvamacademy.com/](http://www.ekatvamacademy.com/) [www.vlearnclasses.com](http://www.vlearnclasses.com)



# Updated return to be accompanied by proof of payment of tax and additional income-tax updated return cannot be submitted unless it is accompanied by proof of Payment as per Sec 140B (i.e tax and additional income-tax).

### Sec 140B How to calculate tax on updated return

Where assessee has not furnished return earlier where no return of income has been furnished by an assessee, he shall before furnishing updated return is liable to pay the tax together with interest and fee payable. The tax payable shall be computed after Reducing:

- The Amount of advance Tax (already paid);
- Any TDS/TCS;
- Any relief of tax claimed u/s 89/90/90A/91;
- Any AMT credit/ MAT credit u/s 115IA/115JD.

Such updated return shall also be accompanied by proof of payment of such tax, additional tax, interest and fee u/s 23F

Where assessee has furnished return earlier- If an Assessee has furnished return, or he (before submitting updated return) is liable to pay the tax due to together with interest & fee payable. The tax payable should be computed after taking into the account of following-

- Amount of Tax paid Earlier
- TDS/TCS
- Any MAT/AMT credit

The aforesaid tax shall be increased by the amount of refund, if any, issued in respect of earlier return. The updated return shall be accompanied by proof of payment of such Tax, additional Tax, interest and fee.

### # Computation of additional Tax

The additional tax payable at the time of furnishing updated return shall be calculated as follows-

If updated return is furnished after the expiry of time available u/s 139(4)/(5) but before completion of 12 months from the end of the relevant AY	25 % of aggregate of tax (+ SC+HEC) and interest as computed
If updated return is furnished after the expiry of 12 months) but before completion of 24 months from the end of the relevant AY	50 % of aggregate of tax (+ SC+HEC) and interest as computed

Where ROI not Furnished  
Interest u/s 234A + 234B + 234C if any

Where ROI Furnished earlier Interest u/s 234B + 234C if any

### # How to calculate interest u/s 234B where an earlier return is furnished :

Where an earlier return has been furnished, interest payable u/s 234B shall be computed on an amount equal to the assessed tax. For this purpose, "assessed tax" means the tax on the total income as declared in updated return after Reducing Following :

- Tax deducted or collected at source on any income which forms part of the total income;
- Any relief of tax claimed u/s 89
- Any tax credit claimed to be set-off in accordance with the provisions of sec 115JD, in case the assessee has exercised the option of shifting out of the default tax regime provided u/s 115BAC(1A) [FA 2023]

### Other points :

The following points should be noted -

- If no earlier return is furnished, interest payable u/s 234A shall be calculated on the basis of tax on total income as declared in the updated return.
- If earlier return is furnished, interest payable under section 234C shall be computed after considering the total income furnished in the updated return as the returned income.
- For the purpose of additional tax, interest payable shall be interest chargeable under any provision of the Act on the income as per updated return, as reduced by interest paid in earlier return. However, the interest paid in the earlier return shall be considered to be nil if no earlier return has been furnished.

## Unsolved Questions

### P.1 Based on sec 10(23B)

State with reasons whether return of income is to be filed in following cases for the A.Y. :

- (i) Mr. X, an individual, aged 80 years, has a gross total income of ₹6.5L & he is eligible for deduction of ₹1.6L under Chapter VI-A.
- (ii) ABC, a partnership firm, has a loss of ₹10,000 during the P.Y.
- (iii) A registered association, eligible for exemption u/s 10(23B), has income from house property of ₹2.6L
- (iv) Mr. Y, aged 45 years, an employee of ABC (P) Ltd, draws a salary of ₹4.9L and has income from fixed deposit with bank of ₹10,000.

### P.2 Based on sec 139(1)

Smt. Kanti engaged in business of growing, curing, roasting & grounding of coffee after mixing chicory had a total income of ₹6L from this business which was her only source of income during year ended. She consults you to have an opinion whether she is required to file ROI for the A.Y. as per provisions of section 139(1).

### P.3 Based on Concept of PAN

Mr. Pranav has undertaken certain transactions during the F.Y. 2023-24, which are listed below. You are required to identify the transactions in respect of which quoting of PAN is mandatory in the related documents –

S. No	Transaction
1.	Payment of life insurance premium of ₹45,000 in the F.Y. 2023-24 by account payee cheque to LIC for insuring life of self and spouse
2.	Payment of ₹1,00,000 to a five-star hotel for stay for 5 days with family, out of which ₹60,000 was paid in cash
3.	Payment of ₹80,000 by ECS through bank account for acquiring the debentures of A Ltd., an Indian company
4.	Payment of ₹95,000 by account payee cheque to Thomas Cook for travel to Dubai for 3 days to visit relatives
5.	Applied to SBI for issue of credit card.

ROI  
15.10



# Chapter 16

## ALTERNATE MINIMUM TAX

Sr No	Particulars	Pg No
1	Alternate Minimum Tax	16.2
2	Sec 115JC Applicability	16.2
3	Sec 115JD AMT credit	16.2
4	Sec 115JEE Application to certain persons	16.2
5	Unsolved Questions	16.2

“  
**LEARN**  
to  
**LET**  
**GO**  
”



AMT  
16.1

CA CS VIJAY SARDA  +91 89566651954

[www.ekatvamacademy.com/](http://www.ekatvamacademy.com/) [www.vlearnclasses.com](http://www.vlearnclasses.com)

## Alternate Minimum Tax

Is applicable to all assessee except **COMPANY**.

### Sec 115JC Applicability

As Per Sec 115JC(1), Income Tax Payable by any person **Higher of -**

- Income Tax payable as per Normal Provision of Income Tax.
- 18.5% of Adjusted Total Income [Surcharge, if applicable + 4% Cess]

### Sec 115JC(2) - Calculation of Adjusted Total Income -

Particulars	Amt
Taxable income of the taxpayer	xxx
<b>Add:</b> Amount of deduction under chapter VIA under the heading <b>C-Deductions in respect of certain incomes</b> [For Intermediate level, the relevant sections are 80JJA, 80QOB & 80RRB] [FA 2023]	xxx
<b>Add:</b> Amount of deduction claimed under section 35AD (as reduced by the amount of depreciation allowable in accordance with the provisions of section 32)	xxx
<b>Add:</b> Amount of deduction claimed u/s 10AA [SEZ]	xxx
<b>Less:</b> Depreciation allowable as per section 32 assuming that ded <sup>n</sup> u/s 35AD was not allowed on assets on which ded <sup>n</sup> u/s 35AD is claimed	(xxx)
Adjusted total income	XXX

# **Individual/ HUF/ AOP/ BOI** and artificial juridical person, paying tax under default tax regime u/s 115BAC, are also not liable to alternate minimum tax u/s 115JC. [FA 2023]

**Sec 115JC(3)** - Every person to whom this section applies shall obtain a report, atleast 1 month prior to the date of filing ROI  
**Sec 115JC(4)** - If the Assessee is a unit located in an International Financial Services Centre & derives its income solely in convertible foreign exchange, rate shall be 9%.

Incase of **Co-op Society AMT** would be leviable at the rate of 15% of ATI instead of 18.5%

**Sec 115JC(5)** - The provisions of this section shall not apply to a person who has exercised option referred to in sec 115BAC / 115BAD.

AMT  
16.2

CA CS VIJAY SARDA +91 8956651954

## Sec 115JD AMT Credit

- > IF AMT Normal Income Tax then excess shall be AMT Credit
- > It shall be **c/f for 15AY**
- > Credit shall be setoff in year in which regular tax is More than AMT
- > Tax credit shall be allowed set off in a year when Tax as per Normal Provision AMT
- > Provided that where amount of tax credit in respect of any income-tax paid in any country or specified territory outside India, u/s 90 or sec 90A or sec 91, allowed against the alternate minimum tax payable exceeds the amount of the tax credit admissible against the regular income-tax payable by the assessee, then, while computing amount of credit under this sub-section, such excess amount shall be ignored.
- > The provisions of this section shall not apply to a person who has exercised option referred to in sec 115BAC/115BAD.

## Sec 115JEE Application To Certain Persons

The Provisions of this Chap shall apply to a person who has claimed any deduction under :

- Any sec (other than sec 80P) included in Chap VI - A under the head "C- Deduction in respect of certain incomes" or
- Sec 10AA; or
- Sec 35AD

AMT is not payable by :

- Individual
- HUF
- AOP/BOI
- Artificial Judicial Persons

If Adjusted total income of such persons does not exceed 20 lakhs

## Unsolved Questions

P.1 Mr. Rajesh has income of ₹45 lakhs under the head "Profits and gains of business or profession". One of his businesses is eligible for deduction @100% of profits u/s 80-IB for A.Y. 2024-25. The profit from such business included in the business income is ₹20 lakhs. Compute the tax payable by Mr. Rajesh, assuming that he has no other income during P.Y.

www.ekatvamacademy.com/ www.vlearnclasses.com



# Chapter 17

## COMPUTATION OF TOTAL INCOME

Sr No.	Particulars	Pg No
1	Unsolved Questions	17.2

“

Working on  
**MYSELF**  
**FOR MYSELF,**  
**BY MYSELF**

”



## Unsolved Questions

### P.1 Based on total income and tax payable

From the following particulars furnished by Ms. Surbhi for the year ended 31.3.2024, you are requested to compute his TI and tax payable for the AY 2024-25, assuming that he does not opt for paying tax u/s 115BAC.

- Ms. Surbhi retired on 31.12.2023 at the age of 58, after putting in 25 years and 9 months of service, from a private company at Mumbai.
- She was paid a salary of ₹ 25,000 p.m. and HRA of ₹ 6,000 p.m. He paid rent of ₹ 6,500 p.m. during his tenure of service.
- On retirement, he was paid a gratuity of ₹ 3,50,000. He was covered by the payment of Gratuity Act. Ms. Surbhi had not received any other gratuity at any point of time earlier, other than this gratuity.
- She had accumulated leave of 15 days per annum during the period of his service; this was encashed by Ms. Surbhi at the time of his retirement. A sum of ₹ 3,15,000 was received by him in this regard. His average salary may be taken as ₹ 24,500. Employer allowed 30 days leave per annum.
- After retirement, he ventured into textile business and incurred a loss of ₹ 80,000 for the period upto 31.3.2024.
- Ms. Surbhi has deposited ₹ 1,00,000 in public provident fund.

### P.2 Based on residential status & total income :

Miss Charlie, an American national, got married to Mr. Radhey of India in USA on 2.03.2023 and came to India for the first time on 16.03.2023. She left for USA on 19.9.2023. She returned to India again on 27.03.2024. While in India, she had purchased a show room in Mumbai on 22.04.2023, which was leased out to a company on a rent of ₹ 25,000 p.m. from 1.05.2023. She had taken loan from a bank for purchase of this show room on which bank had charged interest of ₹ 97,500 upto 31.03.2024. She had received the following cash gifts from her relatives and friends during 1.4.2023 to 31.3.2024:

- From parents of husband ₹ 51,000
  - From married sister of husband ₹ 11,000
  - From two very close friends of her husband (₹ 1,51,000 and ₹ 21,000)
- ₹ 1,72,000

(a) Determine her residential status and compute the total income chargeable to tax along with the amount of tax liability on such income for the AY 2024-25.

(b) Would her residential status undergo any change, assuming that she is a person of Indian origin and her total income from Indian sources is 18,00,000 and she is not liable to tax in USA?

### P.3 Based on total income

Mr. Y Carries on his Own business, An analysis of his Trading and Profit & Loss for the year ended 31.03.2024 revealed the following information:

i) The Net profit was ₹ 1,11,20,000.

The following incomes were credited in the profit and loss Account:

- Dividend ₹ 2,20,000
- Interest on Debentures ₹ 1,75,000
- Winnings from Races ₹ 1,50,000
- It was found that some Stocks were omitted to be included in both the Opening the Closing Stocks, the value of which were:
  - > Opening Stock ₹ 80,000
  - > Closing Stock ₹ 1,20,000
- ₹ 10,00,000 was debited in the Profit and Loss Account being contribution to a University approved and notified u/s 35(1)(ii).
- Salary includes ₹ 2,00,000 paid to his brother which is unreasonable to the extent of ₹ 25,000.
- Advertisement Expenses include 15 gift packets of dry fruits costing ₹ 10,000 per packet presented to important customer
- Total expenses on car was ₹ 7,80,000. The Car was used both for Business and Personal purposes 3/4th is for Business purposes.
- Miscellaneous Expenses included ₹ 30,000 paid to A & Co., Goods Transport Operator in Cash on 31.01.2024 for Distribution of the company's product to the Warehouse.
- Depreciation debited in the books Was ₹ 5,50,000. Depreciation allowed as per IT Rules was ₹ 7,50,000.
- Drawing ₹ 1,00,000.
- Investment in NSC ₹ 1,50,000.

Compute the Total Income of Mr. Y for the AY. 2024-25.

CTI  
17.2



#### P.4 Computation of Total Income - Taxation of Individuals

Mr. Raghuvver, a Resident Individual aged 35 years, furnished the following information from P&L A/c for the year ended 31st March 2024:

- (i) The Net Profit was 6,50,000.
- (ii) The following Incomes were credited in the P&L A/c:
  - (a) Interest on Government Securities 25,000.
  - (b) Dividend from a Foreign Company 18,000.
  - (c) Gold Coins worth 55,000 received as Gift from his father.
- (iii) Depreciation debited in the books of a/c was 85,000. Depreciation allowed as per IT Act, 1961 was 96,000.
- (iv) Interest on Loan amounting to 68,000 was paid in respect of Capital borrowed for the purchase of the New Asset which has not been put to use till 31st March 2024.
- (v) General Expenses included:
  - (a) An expenditure of 20,500 which was paid by a Bearer Cheque.
  - (b) Compensation of 4,500 paid to an Employee while terminating his services in Business Unit
- (vi) He contributed the following amounts by Cheque:
  - (a) 45,000 in Sukanya Samridhi Scheme in the name of his minor daughter Alpa.
  - (b) 20,000 to the Swachh Bharat Kosh set up by the Central Government.
  - (c) ₹ 28,000 towards Premium for Health Insurance & 2,500 on account of Preventive Health Checkup for Self and his wife.
  - (d) ₹ 35,000 on account of Medical Expenses of his father aged 82 years (no Insurance Scheme had been availed on the health of his father).

You are required to compute the Total Income of Mr. Raghuvver.

#### P.5 Total Income - Professional, Cash basis Accounting

Ms. Vaishnavi (aged 50 years,) a Resident Individual and Practicing Chartered Accountant furnishes you the receipts and payments Account for the PY. 2023-24.

Receipts.	₹	Payments	₹
Op. Bal- Cash in Hand & Cash at Bank 1st April	12,000	Staff Salary, Bonus and Stipend to Articled Clerks	21,50,000
Fees from Professional Services	59,98,000	Other Administrative Expenses	11,48,000
Motor Car Loan from Canara Bank @ 9.5% P.a.	2,50,000	Office Rent	80,000
Rent	50,000	Housing Loan repaid to SBI (Incl. Int. of ₹ 88,000)	1,88,000
		Life Insurance Premium	24,000
		Motor Car (acquired in January 2022)	4,25,000
		Medical Insurance Premium (for Self and Wife)	18,000
		Books bought of Annual Publications	20,000
		Computer acquired (Professional use)	30,000
		Domestic Drawings	2,72,000
		Public Provident Fund Subscription	20,000
		Motor Car Maintenance	10,000
		Cl. Bal- Cash in Hand & Cash at Bank 31st march	19,15,000
<b>Total</b>	<b>62,50,000</b>	<b>Total</b>	<b>62,50,000</b>

#### Following Further information is given to you:

- 1) She Occupies 50% of the building for own residence and let –out the balance for residential use at a monthly rent of ₹ 5,000. The building was constructed during the year 1999-2000.
- 2) Motor Car was put to use both for official and Personal purpose. One-Fifth of the Motor Car use is for personal purpose. No Car Loan Interest was paid during the year.
- 3) The Written Down Value of Assets as on 01.04.2023 are given below:

Particulars	₹
Furniture & Fittings	60,000
Plant & Machinery (Air-Conditioners, Photocopiers, etc)	80,000
Computers	50,000

Ms Vaishnavi follows regularly the Cash System of Accounting. Compute the Total income of Ms Vaishnavi for the AY. 2024-25. Assume shifts out of 115BAC.



Connect With Me



### AMENDMENTS ON YT

MAY / JUNE	MARCH
NOV / DEC	SEPT

Before asking any Query, Please do following

1. Please Subscribe Youtube Channel CA Vijay Sarda
2. Please Check Lecturewise Schedule
3. Concept Related Query Number (only Whatsapp) : 89566651954
4. Tech Support Number : 8956784254 / 8956784255
5. Change your book in 1 year. so as to get them updated, Its better to Refer Fast Track Course

## ALL INDIA RANKER'S

02	04	08	09	09	12	17	18	23	50
24	26	29	31	32	37	37	48		



**EKATVAM**  
ACADEMY

COMMERCE KE LIYE HAMESHA PRATHAM

Office No 9A, 1st floor, Prestige Point, Bajirao Rd,  
Opp. Chinchchi Talim, Shukrawar Peth, Pune 411002  
Email : [contactekatvamacademy@gmail.com](mailto:contactekatvamacademy@gmail.com)



# YOUR DREAM TEAM



CA CS Vijay Sarda CA CS Darshan Khare CA Abhishek Zaware CA Rishabh Jain CA Yashvant Mangal

## CMA ALL INDIA RANKER'S

