

CA INTERMEDIATE

AS PER NEW SYLLABUS !!!

CORPORATE & OTHER LAWS

SANJEEVNI BOOTI HANDWRITTEN NOTES



CA GURPREET SINGH

PRELIMINARY

Applicability of Companies Act, 2013

- Co. incorporated under this Act
- Co. incorporated under previous Co. law.
- Insurance Co. except provisions are inconsistent with Insurance Act, 1938 Or IRDA Act, 1999
- Banking Co., except provisions are inconsistent with Banking Regulation Act, 1949
- Co. engaged in supply or generation of electricity, except provisions are inconsistent with Electricity Act, 2003
- Other Co. governed by special act except provisions are inconsistent with Special Act
- Body Corporate as may be notified by CG

Important definitions

Section 2(20) – Company (Co.)-

- means a Co. incorporated under this Act or under any previous Co. law.

Section 2(11) – Body Corporate or Corporation -

- includes a Co. incorporated Outside(O/S) India but does not include
 - (a) Co-operative society registered under any law relating to co-operative societies
 - (b) any other body corp. notified by CG

Section 2(87) Subsidiary Co. :-

- In relation to any other Co.
- means a Co. in which the holding Co.
 - (a) Controls the composition of Board of Directors or
 - (b) Exercise/controls more than one-half of total voting power either at its own or together with its subsidiary companies

Explanation: The composition of Co. 's BOD shall be deemed to be controlled by another Co. if that other Co. by exercise of some power exercisable by it at its discretion can appoint or remove all or a majority of directors.

Section 2(46) – Holding Co. :-

- In relation to one or more other companies,
- means a Co.
- of which such companies are subsidiaries companies.

Section 2(6)- Associate Co. :-

- In relation to another Co.
- means a Co. in which other Co.
- **has significant influence**, but which is **not a subsidiary Co.**
- **includes a Joint Venture Co.**

Significant Influence means

- control of **at least 20% of Total Voting power** or
- control of or **participation in business decision** under agreement

*Note :- It has been clarified that the shares held by a Co. in another Co. in a **fiduciary capacity shall not be counted** for the purpose of determining the relationship of associate Co. or subsidiary Co.*

Section 2(68) – Private Co. :-

- means a co. having minimum paid-up share capital as may be prescribed
- And which by its articles
 - (a) **restricts** the right to **transfer its share**
 - (b) excepts OPC, **limit** the number of **members to 200**
 - (c) **prohibits any invitation to public** to subscribe for any securities of the Co.

Note: Counting of members in Private Co

- In case of **Joint holding treat them as single member**
- following persons **shall not be included in number of members**
 - Persons who are in the employment of Co. (**i.e Current Employees**)
 - **former employees of Co.** who were members. of Co. while in that employment & have continued to be members after the employment ceased

Section 2(71) – Public Co. –

- Means a Co. which
- Is not a private Co. &
- Has minimum paid up share capital as may be prescribed
- However **subsidiary of Public Co. shall be deemed to be public Co.** for the purpose of this Act even where such subsidiary Co. continuous to be private Co. in its articles

Section 2(62) - One Person Co. :-

- Means a Co. which has only one person as a member

Section 2(21) – Co. Limited by guarantee :-

- means a Co. having the liability of its members

- limited by the memorandum
- to such amount as the members may respectively undertake
- to contribute to the assets of Co.
- In the event of its being wound up

Section 2(22) – Co. Limited by shares :-

- means a Co. having the liability of its members
- limited by the memorandum
- to such amount, if any, unpaid on the shares respectively held by them

Section 2(92) - Unlimited Co. :-

- means a Co. not having any limit on the liability of its members

Section 2(52) – Listed Co. :-

- means a Co.
- which has any of its securities
- listed on any recognised stock exchange
- Provided that such class of Co. which have listed or intend to list such class of securities as may prescribed in consultation with SEBI, shall not be considered as listed Co.

According to Rules, the following classes of companies shall not be considered as listed companies, namely:-

- (a) Public companies which have not listed their equity shares on a recognized stock exchange but have listed their –
 - (i) non-convertible debt securities issued on private placement basis or
 - (ii) non-convertible redeemable preference shares issued on private placement or
 - (iii) Both
- (b) Private companies which have listed their non-convertible debt securities on private placement basis on a recognized stock exchange
- (c) Public companies which have not listed their equity shares on a recognized stock exchange but whose equity shares are listed on a stock exchange in a jurisdiction as specified in sub-section (3) of section 23 of the Act.

Unlisted Co. means a Co. which is not a listed Co.

Section 2(40) – Financial Statement in relation to Co. includes :-

- Balance sheet as at the end of financial Year
- Profit & Loss A/C for the financial year
- In case of Co. carrying not for profit activity Income & Expenditure A/C for the

Financial Year

- Cash flow statement for the financial year*
- Statement of changes in equity, if applicable
- an explanatory note annexed to, or forming part of any doc. referred above

**Note:- OPC, Small Co., Dormant Co. & Private Start-up Co. may not include Cash Flow Statement.*

Section 2(41) – Financial Year in relation to Co. or Body Corp.

- means period ending on 31st day of march every year &
- where it has incorporated on or after the 1st day of January of a year, the period ending on 31st day March of the following year in respect where of FS of the Co. or Body Corp is made-up.

Provided that

- Where a Co. or Body Corp., which is holding Co. or Subsidiary Co. or Associate Co. of a Co. incorporate outside India and
- Is required to follow a different FY for consolidation of it's A\Cs outside India
- On an application made by the Co. or Body Corp. to CG in such form & manner as may be prescribed.
- The CG may allow any period as its FY whether or not that period is a year.

Section 2(45) – Government Co. –

- Means any Co. in which not less than 51% of paid-up share capital is held
 - By CG or
 - By any SG or SG(s) or
 - Partly by CG & partly by one or more SGs

And

- Includes a Co. which is a subsidiary Co. of such Govt. Co.

Explanation. - For the purposes of this clause, the "paid-up share capital" shall be construed as "total voting power", where shares with differential voting rights have been issued.

Section 2(85) Small Co. –

- Means a Co. other than public Co. whose
- Paid-up share Capital (PUSC) does not exceed Rs.4 crores AND
- Turnover for preceding FY does not exceed Rs.40 Crores
- Nothing in this clause shall apply to
 - Holding Co.
 - Subsidiary Co.
 - Section 8 Co.
 - Co. or Body Corp. governed by any special Act

INCORPORATION OF COMPANY AND MATTERS INCIDENTAL THERETO

Promoter [Section 2(69)]

Promoter means a person

- a. who has been **named as promoter in a prospectus**; or
- b. who is **identified as promoter by the Co. in the annual return**; or
- c. who has control over the affairs of the Co., directly or indirectly whether as a shareholder, director or otherwise; or
- d. in **accordance with whose advice**, directions or instructions the Board of **Directors of the Co. is accustomed to act**, but shall not include a person who is acting merely in a professional capacity such as attorney, technical or functional experts.
- e. To be a promoter, one need not necessarily be associated with initial formation of co. One who subsequently helps to arrange floating of it's capital will equally be regarded as promoter

Formation of Co. [Section 3]

1. A Co. may be **formed for any lawful purpose** by
 - **minimum 7 persons in case of a Public Co.**
 - **minimum 2 persons in case of a Private Co.**
 - **1 person in case of OPC**
 by subscribing to MOA & complying with requirements of this Act.
2. Co. formed as specified above may be incorporated either as;
 - a. Companies limited by shares; or
 - b. Companies limited by guarantee; or
 - c. Unlimited liability companies.

One Person Co. (OPC)

1. Nominee clause ⇒ **MOA of Co. to indicate name of other person** who, becomes member of OPC in case of death/incapacity of subscriber to MOA(current member) of OPC
2. Change of name in nominee clause shall **not be deemed as alteration of MOA**
3. Nominee to give his **prior written consent**
4. Nominee may **withdraw his consent any time by giving notice to member & OPC**
5. **Member of OPC may change the name of nominee**
 - by giving notice in prescribed form
 - Intimating Co. about such change
 - On receipt of such intimation, Co. to inform ROC
6. Only **Natural person + Indian citizen** whether resident in India or otherwise
 - shall be eligible to incorporate OPC
 - Shall be eligible to become nominee for member of OPC
7. Natural Person shall **not be member of more than 1 OPC** at any point of time & the said

- person shall not be nominee of more than 1 OPC
8. Where a natural person **become member in 2 OPC** due to nominee in OPC, such person shall **meet eligibility criteria within 180 days**
 9. No minor shall become member or nominee of OPC
 10. No minor can hold share with beneficial interest
 11. **OPC cannot be incorporated or converted into sec 8 Co.**
 12. OPC can be converted to Private/ Public Co.
 13. OPC cannot carry out Non-banking financial investment activities
 14. OPC cannot invest in securities of any body Corporate
 15. Relaxation available to OPC :
 - Not required to prepare cashflow statement
 - Annual return can be signed by director, not necessarily a company secretary
 - Holding AGM is not necessary
 - AGM & EGM is not applicable
 - only one meeting of the BOD in each half of a calendar year
 - Allowed to file financial statements within six months from the closure of the financial year as against 30 days.

Members Severally Liable in Certain Cases [Section 3A]

If at any time, the **no. of members is reduced below prescribed limit** (i.e. 7 in case of public Co. or 2 in case of private Co.)

AND

Co. **carries on business for more than 6 months** with reduced no. of members, then **every person (member)** who carries on business after those six months is cognizant (aware) of the fact that **business is carried with reduced members shall be liable for the payment of the whole debts of the Co. contracted during that time (after elapse of six months) and may be severally sued**

Incorporation of Co. [Section 7]

1. Application in **SPICe+(INC-32)** with ROC within whose jurisdiction the Registered office of Co. is proposed to be situated along with the following info. & documents:-
 - **MOA (INC-33) and AOA (INC-34) duly signed by all subscribers to MOA**
 - **Declaration (INC-8)** that requirements of Act & rules w.r.t. incorporation is complied with, by
 - a) advocate, CA, Cost Accountant, CS in practice engaged in formation of Co.
 - b) Person named in AOA as director, manager, Secretary of Co.
 - **Address for correspondence** till Registered office is established
 - **Interest of First directors in other firms/Body Corporate & consent** to act as directors of Co.
 - **Particulars of subscribers to MOA+ Proof of identity**
 - a. Name (including surname or family name) and recent Photograph affixed
 - b. Father's/Mother's name
 - c. Nationality, Proof of nationality in case the subscriber is a foreign national
 - d. Date and Place of Birth (District and State)

- e. Educational qualification and Occupation
 - f. Permanent Account Number
 - g. Email id and Phone number of Subscriber
 - h. Permanent residential address and also Present address
 - i. Residential proof such as Bank Statement, Electricity Bill, Telephone / Mobile Bill, provided that Bank statement Electricity bill, Telephone or Mobile bill shall not be more than two months old
 - j. Proof of Identity (For Indian Nationals - Voter's identity card, Passport copy, Driving License copy, Unique Identification Number (UIN) & for Foreign nationals and Non Resident Indians – Passport)
 - k. If the subscriber is already a director or promoter of a Co.(s), the particulars relating to name of the Co.; Corporate Identity Number; Whether interested as a director or promoter
- **Where** the subscriber to the memorandum is a body corporate, then the following particulars shall be filed with the ROC
 - a. The name of the body corporate and Corporate Identity Number of the Co. or Registration number of the body corporate, if any
 - b. GLN, if any
 - c. The registered office address or principal place of business
 - d. E-mail Id
 - e. If the body corporate is a Co., certified true copy of the board resolution specifying inter-alia the authorization to subscribe to the MOA
 - f. If the body corporate is a limited liability partnership or partnership firm, certified true copy of the resolution agreed to by all the partners specifying inter alia the authorization to subscribe to the MOA
 - g. In case of foreign bodies corporate, the details relating to the copy of certificate of incorporation of the foreign body corporate; & the registered office address.
 - **Particulars of first directors + Proof of identity** name, including surname or family name, the Director Identification Number (DIN), residential address, nationality and such other particulars
 - **Declaration(INC-9) from each subscribers** to MOA & person named as **First directors** in AOA that
 - a) He is **not convicted of offences** with respect to promotion, formation or management of any Co.
 - b) **Not found guilty** of any fraud/misfeasance or breach of duty to any Co. under this Act or previous Co. law **during last 5 years**
 - c) **all docs** filed with ROC for registration **contain correct, complete & true information** to best of his knowledge & belief.
2. On basis of above, **ROC shall** register and **issue** certificate of Incorporation (**COI**)(INC-11)
 3. **ROC shall allot Corporate Identity Number (CIN)** which shall be distinct identity for Co. & included in COI. CIN is a **21 alpha-numeric digit based unique identification number**, comprising data sections/elements that reveals the basis aspects about Co.
 4. Co. shall **maintain & preserve** at its registered office copies of **all docs & info. as**

originally filed till its dissolution.

5. If person furnishes any false/incorrect particulars of information suppresses any material information of which he is aware in any docs filed with ROC, such **person is liable for action u/s 447**
6. If after incorporation, it is proved that Co. is incorporated by furnishing false/incorrect information or representation or by suppressing any material info or by fraudulent action then **Promoters, first directors & person making declaration shall be liable for action u/s 447**
7. Where a Co. has been got incorporated by
 - a. furnishing false or incorrect information or representation, or
 - b. by suppressing any material fact or information in any of the documents or declaration filed or made for incorporating such Co. or
 - c. by any fraudulent action, then on application made to National Company Law Tribunal (NCLT or Tribunal), It may pass order
 - i. for **regulation of mgt. of Co.** including changes in MOA/AOA
 - ii. **Direct liability of members shall be unlimited**
 - iii. **Direct removal of name** of Co. from Register of Cos.
 - iv. for **winding up** of Co.
 - v. **as it may deem fit**

Prior to passing such order- **Reasonable opportunity of being heard (OOBH)** to Co. + take into consideration transactions already entered into by Co.

Formation of Companies with Charitable Objects, Etc. [Section 8]

1. Where CG (delegated to RoC) is satisfied that a person / AOP proposed to be register as Limited Co.

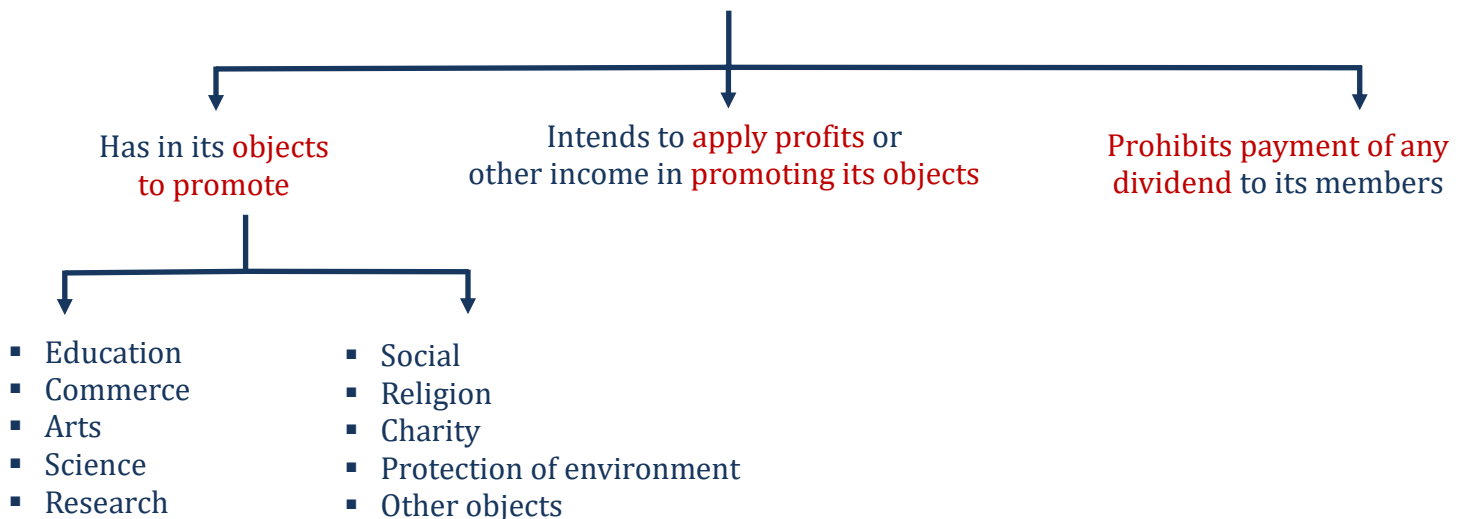

2. Once license is issued, then **ROC shall register such Co. as limited Co.** without addition of word "limited" of "Private limited" as the case may be.
3. Can a firm become member of Sec 8 Co. ⇒ Yes
4. Sec 8 Co. requires prior permission from
 - CG (delegated to RD) for alteration of its MOA

- CG (delegated to ROC) for alteration of its AOA
- 5. By passing **SR at GM**, Sec 8 Co. can be converted to any other kind of Co.
- 6. Reasons for Revocation of license:-
 - **Contravenes** of any requirements of Section 8
 - Contravenes any **condition subject to which the license is issued**
 - **affairs** of Co. are **conducted fraudulently** or in violation of the objects of the Co. or **prejudicial to public interest**
- 7. Powers of CG (delegated to RD)
 - (a) after giving reasonable **OOBH**
 - **revoke license**
 - direct the **Co. to convert its status**
 - change its name to **add word "limited" or "private limited"**.
 - (b) Where license is revoked, CG may, in public interest
 - after reasonable **OOBH**
 - **Order for winding up** under the Act or
 - **amalgamate such Co. with other Sec 8 Co.** having similar objects
 - (c) In case of winding up, **any surplus asset** left after satisfaction of its debts & liabilities
 - **transfer to another Sec 8 Co.** subject to T&C imposed by Tribunal or
 - **Sold & proceeds** of such assets **credited to Insolvency & Bankruptcy Fund**
- 8. Punishment for default:-

| Particulars | Co. | Directors & officer in default |
|--------------------|------------|---|
| Minimum fine | ₹ 10 Lakhs | ₹ 25,000 |
| Maximum fine | ₹ 1 Crores | ₹ 25 Lakhs |

- 9. When it is proved that affairs of Co. were conducted fraudulently, every officer in default liable for action u/s 447

Conversion of Section 8 Co. Into Other Kind of Co.

Sec 8 Co. may convert itself into Co. of any other kind :-

- a. Sec 8 Co. shall pass **SR at GM** for approving such conversion
- b. **Explanatory statement** to notice must mention the **detailed reason of such conversion**.
- c. File **application in INC-18 with RD** along with a certified true copy of the SR and a notice convening meeting including the explanatory statement for approval for conversion.

Also attach the proof of serving of the notice served by registered post or hand delivery, to:

- the Chief Commissioner of Income Tax having jurisdiction over the Co.,
- Income Tax Officer who has jurisdiction over the Co.,
- the Charity Commissioner,
- the Chief Secretary of the State in which the registered office of the Co. is situated,

- any organisation or Department of the CG or SG or other authority under whose jurisdiction the Co. has been operating.
 - If any of these authorities wish to make any representation to RD, it shall do so within sixty days of the receipt of the notice, after giving an opportunity to the Co.
- d. A copy of the application with annexures shall also be filed with the RoC
 - e. Within a week from application filing date, Co. shall, publish a notice in INC-19 at its own expense in English and Vernacular newspaper, and a copy of the notice shall be sent forthwith to the RD & same shall be uploaded on the website of the Co., if any, and as may be notified or directed by the Central Government.
 - f. The Co. should have filed all its financial statements and Annual Returns upto the financial year preceding the submission of the application to the RD and all other returns required to be filed under the Act up to the date of submitting the application to the RD
- Note: In the event the application is made after the expiry of three months from the date of preceding financial year to which the financial statement has been filed, a statement of the financial position duly certified by chartered accountant made up to a date not preceding thirty days of filing the application shall be attached.*
- g. RD shall issue order approving the conversion subject to T&C as may be imposed
 - h. Before imposing conditions or rejecting application, the Co. shall be given a reasonable OOBH by the RD
 - i. On receipt of the approval , the Co. shall convene a general meeting to pass a SR for amending its MOA & AOA thereafter file these with the RoC
 - j. On receipt of the documents, the ROC shall register the doc and issue the fresh COI.

Effect of Registration [Section 9]

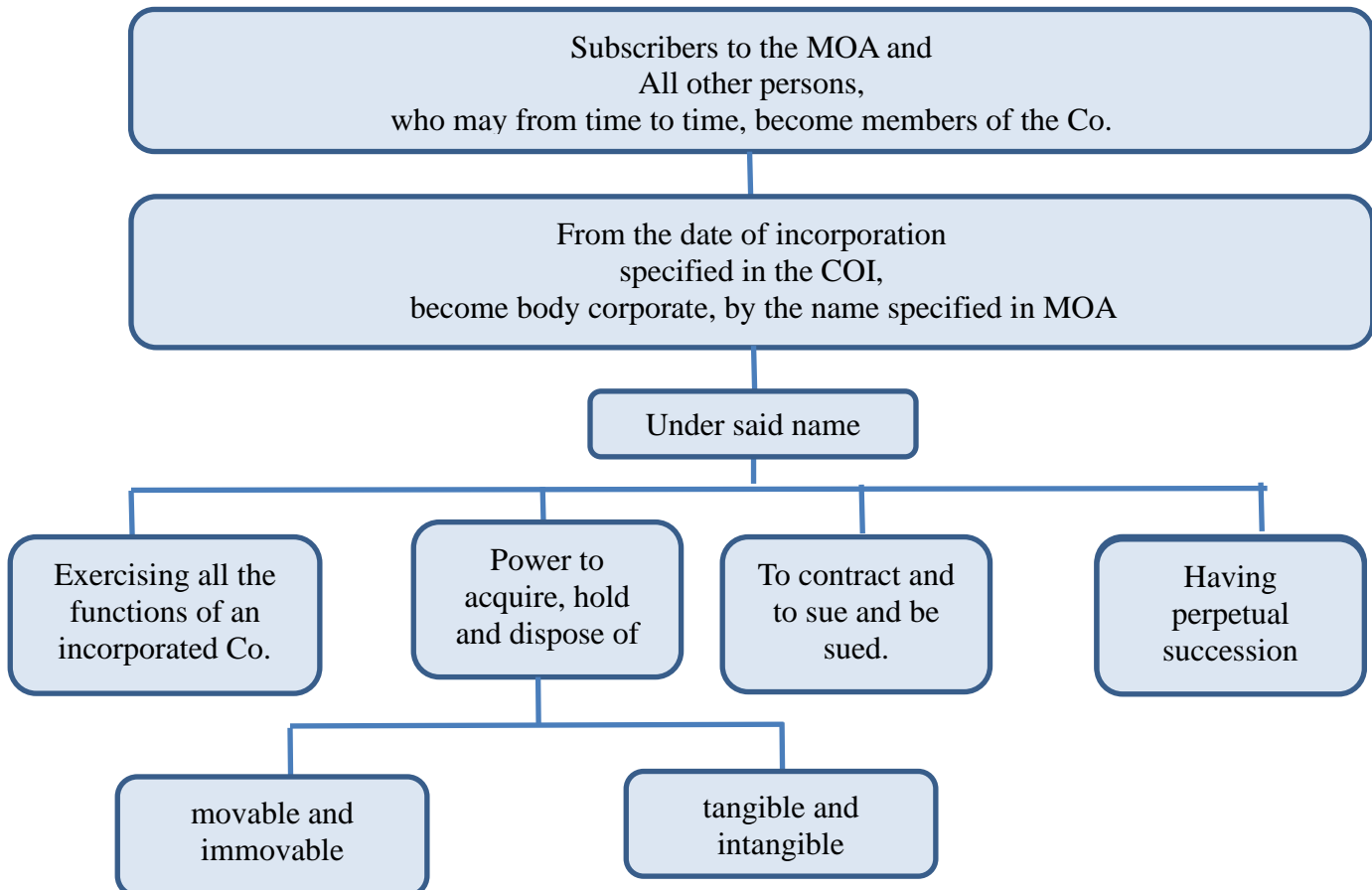

Memorandum of Association/MOA [Section 4]

1. **Fundamental document** for formation of Co.
2. Content of MOA need to be in compliance with Companies Act, 2013
3. MOA **contains object of Co.** beyond which its action cannot go.
4. **MOA is a public document** u/s 399 of companies Act, 2013
5. Every person entering into Contract with the Co. is presumed to have knowledge of conditions contained in MOA. (Doctrine of Constructive notice)
6. Shareholders must know the purposes for which this money can be used by Co.
7. Co. cannot depart from MOA → otherwise ultra vires Act
8. The **MOA of a Co.** shall be **in respective forms** specified in Tables A, B, C, D and E in Schedule I to the Act

Content of MOA

- a) Name clause:-
 - Name of the Co. with last word "**limited**" for Public Co. or "**Private limited**" for Private Co. Not applicable to Sec 8 Co.
- b) Registered office Clause/ Domicile clause/ Situation clause:-
 - **name of state** in which the registered office of Co. is to be situated
- c) Object clause:-
 - **object** for which the Co. is proposed to be incorporated & **any matter incidental thereto**
- d) Liability clause:-
 - Liability of members of Co., **whether limited or unlimited**
 - limited by shares ⇒ liability of members is limited to unpaid amount of shares
 - limited by guarantee ⇒ liability of members is limited upto the amount undertake to contribute in the event of winding up.
- e) Capital clause:-
 - In case of Co. having share capital, **amount of authorised share capital**, dividend into amt & no. of shares
- f) Nominee clause:-
 - In case of OPC, name of person who, in the event of death/incapacity of subscriber, shall become the new member of OPC.
- g) Subscription Clause
 - **number of shares each subscribers agree to subscribe** opposite to his name which shall not be less than one share

Application for reserving name

| Name reservation for New Co. | Name reservation for Existing Co. |
|---|--|
| a) A person may make an application in SPICe+INC-32 with ROC for reservation of name of proposed Co. b) Resubmission shall be allowed within 15 days , for rectification of defect, if any. c) Upon receipt of an application the RoC may reserve the name for a period of twenty days from the date of approval | a) A person may make an application, using web service RUN (Reserve Unique Name) to the ROC for the reservation of a name to which the company proposes to change its name. b) Resubmission shall be allowed within 15 days , for rectification of defect, if any. c) Upon receipt of an application from existing Co., the ROC may reserve the name for a period of sixty days from the date of approval |

An application for extension of reservation of name can be made before expiry of 20 days;

- a. For another 20 days (total of 40 days) with fee of Rs 1000, which may be further extend by another 20 day (total of 60 days) with fee of Rs 2000.

Or

- a. For another 40 days (total of 60 days) with fee of 3000

Articles of Association - AOA [Section 5]

1. AOA shall contain internal rules & **regulations for management of Co.**
2. AOA to include such **matters as may be prescribed** (forms given in Schedule I)
3. Co. may include **additional matters in AOA** as may be considered necessary for mgt.
4. Entrenchment :-
 - a) AOA may contain provision for entrenchment
 - b) Meaning:- Specific provision of AOA may be altered only if **conditions that are more restrictive than those applicable in case of special resolution, are met or complied with.**
 - c) Provision for entrenchment shall be made
 - either on formation of a Co. or
 - by amendment in AOA agreed by
 - **All members in case of Pvt Co.**
 - **SR in case of public Co.**
 - d) Co. must **give notice to ROC** of provision of entrenchment
 - New Co. –INC-32
 - Existing Co. – MGT-14 within 30 days
5. AOA shall be in respective forms specified in **Tables F, G, H, I & J** in Schedule I to the Act
6. Co. may **adopt all or any regulations** contained in model articles applicable to such Co.

7. Any Co., which is registered after the commencement of this Act either **exclude or modify expressly** or else it applies what stated in model forms applicable to that Co.

Doctrine of Indoor Management

Doctrine of Indoor Management

1. Persons dealing with Co. **cannot assumed to have knowledge of internal problems** of Co.
2. Stakeholders **need not enquire** whether necessary meeting was convened & held properly or whether necessary resolution was passed properly.
3. This doctrine helps **protect outsiders from the Co.**
4. **Outsiders** are entitled to **presume that internal proceedings and requirements have been duly met (Royal British v/s Turquand)**

Basis for Doctrine of Indoor Mgt

- What happens internal in Co. is not matter of public knowledge.
- Outsider can only presume the intentions of a Co., but not know the information he/ she is not access to.
- If not for the doctrine, **Co. could escape creditors by denying the authority of officials to act on its behalf**

Exception to Doctrine of Indoor Management

1. Knowledge of irregularity

In case, outsider has **actual knowledge of irregularity** within the Co., benefit under Doctrine of Indoor Mgt would no longer be available. In fact, he / she may be considered part of irregularity

2. Negligence

If with minimum of effort, irregularities within a Co. could be discovered, the benefit of Doctrine of Indoor Mgt. would not apply. The protection of rule is also **not available where the circumstances surrounding the contract are so suspicious as to invite enquiry & the outsider dealing with Co. does not make proper inquiry.**

3. Forgery

The rule does not apply where person relies upon document that turns out to be forged since **nothing can validate forgery.**

4. Where the **question is in regard to the very existence of an agency.**
5. The act done is not merely ultra vires the directors/officers but **ultra vires the Co. itself.**

Doctrine of Ultra Vires

1. The word 'ultravires' means beyond powers.
2. In case of Co. whatever is not stated in MOA as objects is prohibited by Doctrine of ultra vires.
3. An act which is ultra vires is void & does not bind the Co.
4. The doctrine of ultra vires was first enunciated by the House of Lords in a classic case of **Ashbury Railway Carriage and Iron Co. Ltd. v. Riche.**

5. Essence: To protect shareholders and the creditors of the company or anyone who deals with the company
6. Effect :-
 - a. Whenever an ultra vires act is about to be undertaken, any member of the Co. can get an injunction to restrain it from proceeding with it.
 - b. Neither party (even outsider) can sue for enforcement or specific performance of such agreement.

Act to Override MOA, AOA, Etc. [Section 6]

Save as otherwise expressly provided in this Act

- a) Provisions of this Act shall have overriding to the provisions contained in
 - MOA
 - AOA
 - Agreement executed by Co.
 - BOD resolution
 - Member resolution
- b) any provision contained in MOA, AOA, agreement or resolution shall be void which is conflicting to the provisions of this Act.

Effect of Memorandum and Articles [Section 10]

1. When the MOA and AOA got registered; it shall bind the
 - a. Members to the Co.;
 - b. Co. to the members;
 - c. Members to the members;To observe all the provisions of the MOA and of the AOA, as signatory thereof.
2. All monies payable by any member to the Co. under the memorandum or articles shall be a debt due from him to the Co..
Example - A Co. can recover calls in arrear from a member as forcefully as it is recovering loan due.

Note :- "No Article can constitute a contract between the Co. and a third person."

Alteration in MOA [Section 13]

1. Co. may alter the provisions of its MOA with the approval of the members by a special resolution.
2. Further, Co. shall file with ROC copy of such special resolution.

3. Change in Names clause

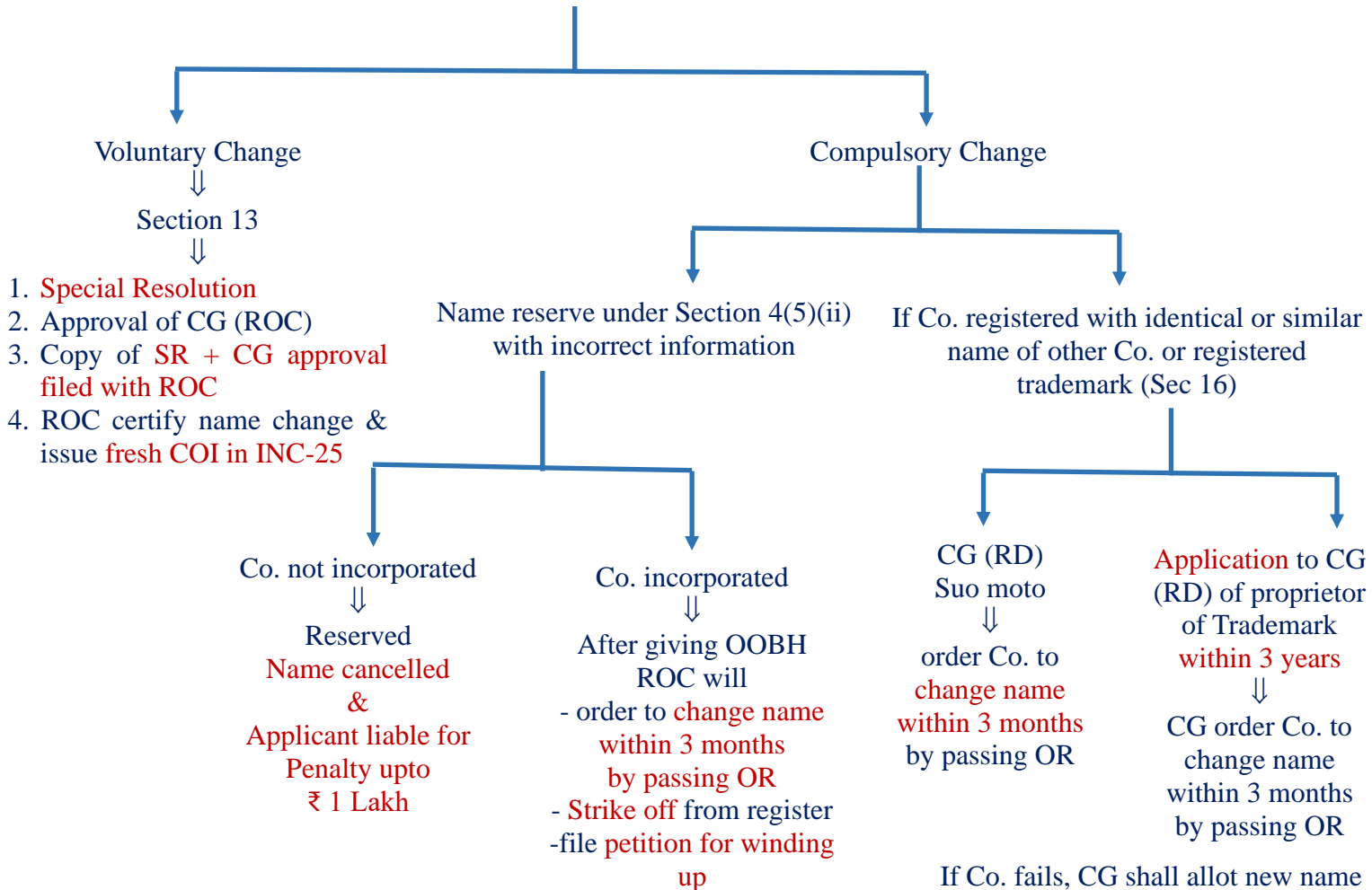

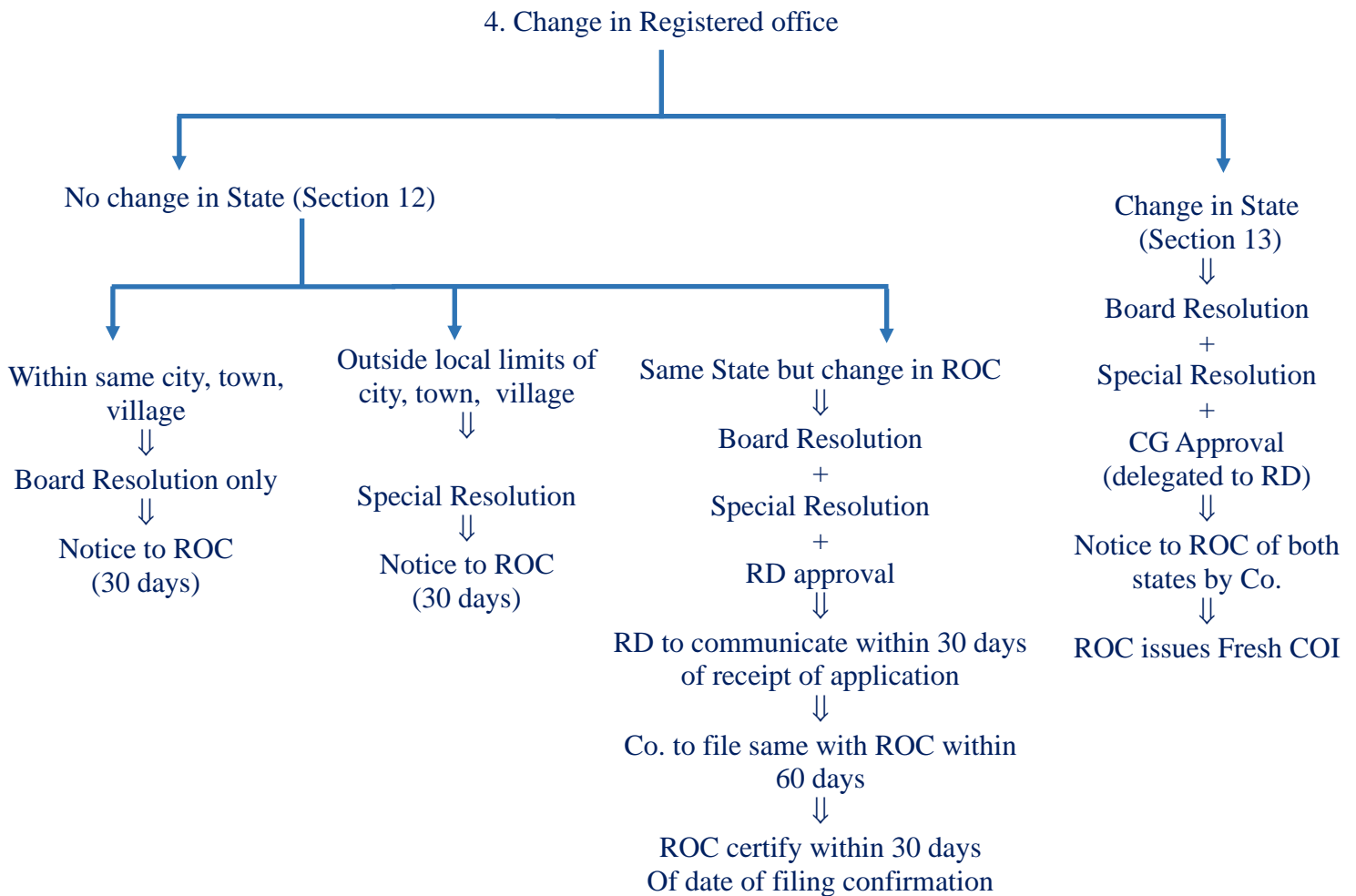

5. Change in the registered office from One State to Another State (detailed)

The alteration of the MOA relating to the place of the registered office from one State to another shall not have any effect unless it is **approved by the CG (power delegated to RD) on an application in Form No. INC-23** along with the fee and shall be **accompanied by the following documents**, namely;

- a. Copy of **MOA with proposed alterations**;
- b. Copy of the **minutes of the general meeting** at which the resolution authorising such alteration was passed, **giving details of the number of votes cast in favour or against the resolution**;
- c. Copy of **Board Resolution** or Power of Attorney or the executed vakalatnama, as the case may be.
- d. **List of creditors and debenture holders**
- e. Acknowledgment of service of a copy of the application with complete annexures to the ROC and Chief Secretary of the State Government or Union territory where the

registered office is situated at the time of filing the application.

Advertisement in Newspapers

The Co. not more than 30 days before the date of filing the above application, shall advertise in the **Form No. INC-26 in vernacular newspaper and in English newspaper**

Dispose of the application by central government

The **CG (power delegated to RD)** shall dispose of the application within a period of 60 days.

Before passing of order, CG may satisfy itself that-

- a. the alteration has the consent of the creditors, debenture-holders and other persons concerned with the Co., or
- b. the sufficient provision has been made by the Co. either for the due discharge of all its debts and obligations, or
- c. adequate security has been provided for such discharge.

Where an alteration of the memorandum results in the transfer of the registered office of a Co. from one State to another, a certified copy of the order of the CG approving the alteration shall be filed by the Co. with the ROC of each of the States in Form No. INC-28 along with the fee within 30 days from the date of receipt of certified copy of the order, who shall register the same.

Issue of fresh certificate of incorporation The ROC of the State where the registered office is being shifted to, shall issue a fresh COI indicating the alteration.

6. Change in object clause

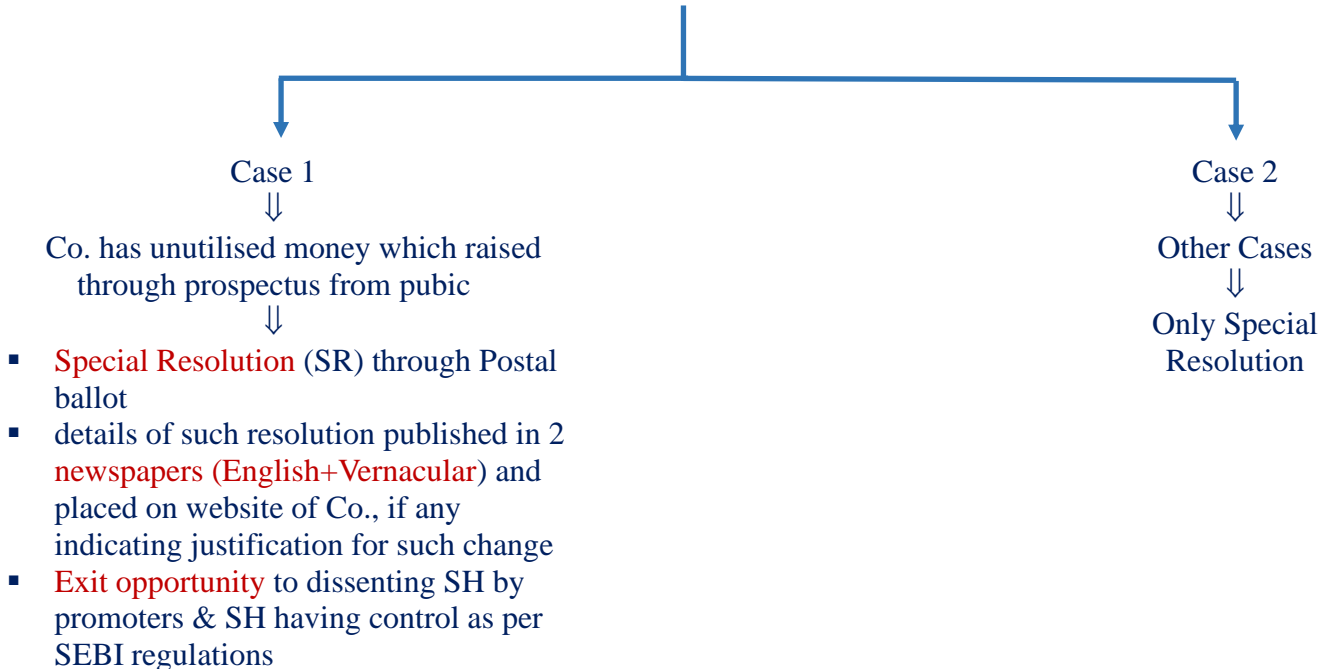

The notice in respect of the resolution for altering the objects shall contain the following particulars, namely;

- a. **Total money received;**
- b. **Total money utilised** for the objects stated in the prospectus;
- c. **Un-utilized amount** out of the money so raised through prospectus,
- d. Particulars of the **proposed alteration** or change in the objects;
- e. **Justification for alteration** or change in the objects;
- f. **Amount proposed to be utilised for the new objects;**
- g. Estimated financial impact of the proposed alteration on the earnings and cash flow of the Co.;
- h. Other relevant information which is necessary for the members to take an informed decision on the proposed resolution;
- i. Place from where any interested person may obtain a copy of the notice of resolution to be passed.
- j. Advertisement in Newspapers
 - The advertisement giving details of each resolution to be passed for change in objects, simultaneously dispatch of postal ballot notices to shareholders
 - Published in vernacular newspaper and in English newspaper which is in circulation at the place where registered office of the company is situated
 - Hosted on the co. website

Alteration of AOA [Section 14]

1. By **passing SR**, Co. may alter its AOA
2. Alteration of AOA includes conversion of
 - a) Pvt Co. to Public Co.
 - b) **Public Co. to Pvt. Co. (subject to CG approval) (conversion of public co. into pvt co. shall not valid unless application made within 60 days from date of passing SR be filed with RD in e-Form RD-1)**
3. Where a Pvt Co. alter its article such that it does not include restriction which a Pvt. Co. is required to include in AOA as per Act, such Pvt. Co. shall cease to be private from date of alteration
4. Following documents shall be filed with **ROC within 15 days** of alteration of AOA for registration
 - Every alteration of AOA
 - Approval of CG for such alteration
 - Printed copy of altered articles
5. Any alteration of AOA registered shall be valid as if it were originally in the articles

Alteration of Memorandum or Articles to be Noted in Every Copy [Section 15]

1. **Every alteration made** in MOA and AOA of a Co. shall be **noted in every copy**
2. On default ⇒ **Co. & every officer in default - liable to penalty of ₹1000 for every copy issued w/o alteration**

Section 17 - Copies of Memorandum/articles etc. to be given to members

1. On being requested by member, Co. shall send to him within 7 days of request subject to payment of such fees as may be prescribed copy of each of following documents
 - MOA
 - AOA
 - Agreements & resolutions u/s 117(1) not included in MOA/AOA
2. If default u/s 17 → Co. + every officer in default - ₹1000/ day or ₹ 1 lakh whichever is lower

Registered Office of Co. [Section 12]

1. Within 30 days of incorporation and at all times thereafter, Co. shall have a Registered office (RO) capable of receiving communication & notices
2. Co. shall furnish to ROC, verification report of RO within 30 days of incorporation
3. Change in RO- Refer chart
4. Labeling of Co. - Every Co. shall
 - a) paint / affix its name, address of RO on the outside of every office in which its business is carried on, in a conspicuous place, in legible letters in languages in general use in that locality
 - b) have its name engraved in legible characters on its common seal, if any
 - c) following details printed in all its business letters, bill heads, letter papers & other official publications
 - Name
 - RO address
 - CIN
 - Telephone number
 - Fax number, if any
 - e-mail
 - website address
 - d) have its name printed on hundies, promissory notes, bills of exchange & such other docs as prescribed

Note:- In case of name change during last 2 years, print or affix the former name as well.

In case of OPC, words "One person Co." to be mentioned in bracket below such name.

5. If any default is made in complying with this section, Co. & every officer in default shall be liable to penalty of ₹ 1000 / day during which default continues but not exceeding ₹ 1 lakh
6. If ROC has reasonable ground to believe (RGTB) that Co. is not carrying any business or operation, he may cause a physical verification of RO in prescribed manner & if any default is found to be made in complying with requirements of sub-section (1), → Initiate action for removal of name of Co. from Register of Cos.

Commencement of Business Etc. [Section 10A]

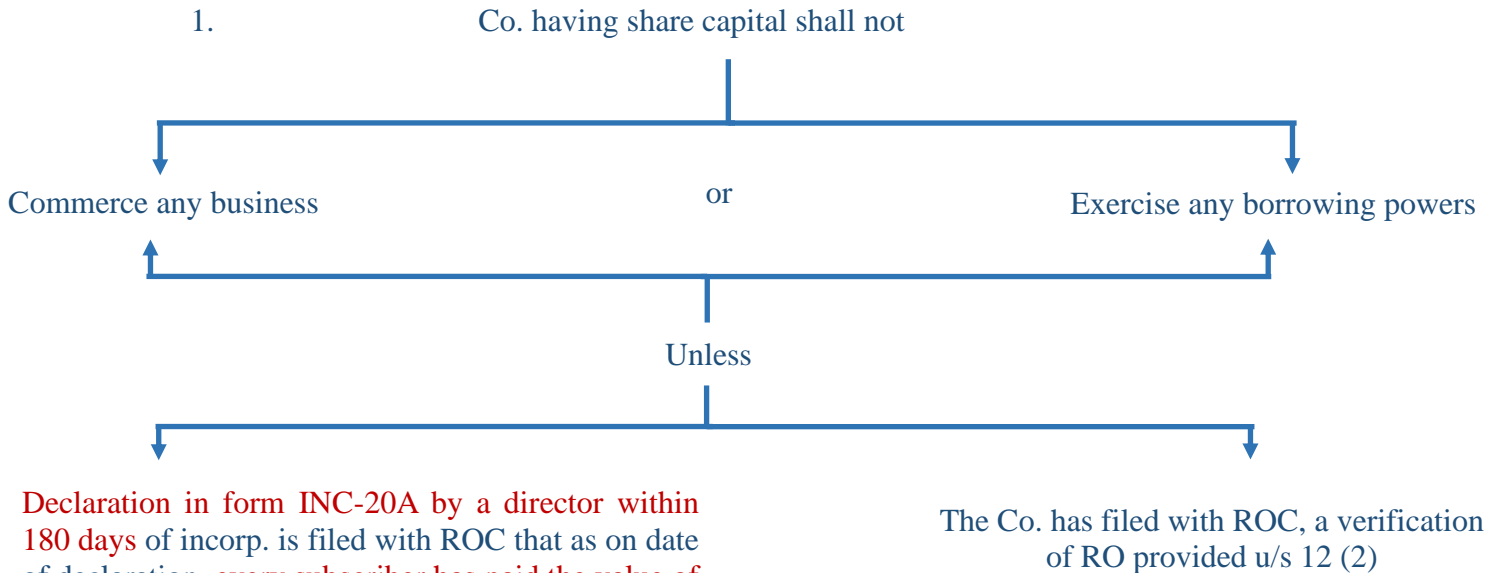

Declaration in form INC-20A by a director within 180 days of incorp. is filed with ROC that as on date of declaration, every subscriber has paid the value of shares agreed to be taken



Content of said form shall be verified by CS/CA/Cost Accountant, in practice



In case Co. requires registration / approval from any sectoral regulator- such registration / approval obtained & attached with the declaration.

The Co. has filed with ROC, a verification of RO provided u/s 12 (2)

2. If any default under this section, Co. - ₹ 50000 & officer in default - ₹ 1000/day up to ₹ 1 Lakh
3. If no declaration is given within 180 days & ROC has RGTB that Co. is not carrying on any business or operations, ROC may initiate action for removal of name of the Co. from register of Cos.

Conversion of Companies Already Registered [Section 18]

1. Co. of any class registered under this Act may convert itself as Co. of other class under this Act by alteration of MOA & AOA
2. Where conversion is required to be done under this section
 - On application made by Co.
 - ROC after satisfying himself that provisions of this chapter is complied with
 - ROC shall close the former registration of Co.
 - issue fresh COI in same manner as its first registration.
3. The registration of Co. under this section shall not affect any debts, liabilities, obligation, contracts entered / incurred before conversion may be enforced in the manner as if such

registration had not been done.

Subsidiary Co. Not To Hold Shares in Holding Co. [Section 19]

- ⇒ No Co. (itself/nominees) shall hold any shares in its holding Co.
- ⇒ No Holding Co. shall allot / transfer its shares to any of its subsidiary Co.
- ⇒ Any such allotment / transfer of shares of Co. to its subsidiary Co. shall be void

Exceptions :-

| | | |
|---|---|--|
| 1. Where subsidiary Co. holds such shares as legal representative of deceased member of holding Co. | 2. Where Subsidiary Co. hold such shares as trustee | 3. Where subsidiary Co. is shareholder even before it became subsidiary Co. of holding Co. |
| Right to vote allowed to subsidiary Co. | | Right to vote not allowed |

Service of Documents [Section 20]

1. Document may be served on Co. or its officer by sending it at RO of Co. by
 - Registered post
 - Speed Post
 - Courier Service
 - Leaving it at its RO
 - Means of such electronic or other mode as may be prescribed
2. Document may be served on ROC or any member by sending it to him by
 - Post
 - Registered post
 - Speed Post
 - Courier
 - Delivering at his office or address
 - Means of such electronic or other made as may be prescribed
3. **Member may request delivery through particular mode by paying fees** as determined in AGM

Note : In case of delivery post, such service shall be deemed to have been effected

a. In the case of notice of a meeting, at the expiration of 48 hours after the letter containing the same is posted and

b. In any other case, at the time at which the letter would be delivered in the ordinary course of post.

Authentication of Documents, Proceedings and Contracts [Section 21]

Save as otherwise provided in this Act

- a) Document or proceeding requiring authentication by Co. or
- b) Contracts made by or on behalf of Co. may be signed by
 - **KMP** or
 - **Officer or employee of Co. duly authorised** by Board in this behalf

Execution of Bills of Exchange, Etc. [Section 22]

1. BOE/hundi/Promissory note
 - **shall be deemed** to have been
 - made/accepted/drawn/endorsed
 - **on behalf of Co.** if the same is
 - made/accepted/drawn/endorsed
 - **by any person**
 - **acting under its authority, express or implied**
2. Co. may authorise any person as its attorney to execute other deeds on its behalf in any place (India or o/s India)



3. Deed signed by such attorney on behalf of Co. & under his seal shall bind the Co.

PROSPECTUS AND ALLOTMENT OF SECURITIES

Public Offer and Private Placement [Section 23]

| Type of Co. | Public Issue (Section 23 to Section 41) | Private Placement (Section 42) | Right Issue | Bonus Issue (No Funds raised) |
|-------------------|---|--------------------------------------|----------------|-------------------------------------|
| 23(1) Public Co. | ✓ | ✓ | ✓ | ✓ |
| 23(2) Private Co. | × | ✓ | ✓ | ✓ |

Power of SEBI [Section 24]

- (1) By making regulations, SEBI is empower to administer provisions which relates to issue & transfer of securities and non-payment of dividend;
 - by listed companies or
 - those companies which intend to get their securities listed on any recognised stock exchange in India
- (2) All other matters (including matters relating to prospectus, return of allotment, redemption of preference shares) shall be administered by the CG, Tribunal or the RoC, as the case may be.

Deemed Prospectus [Section 25]

- (1) If Co. allots or agrees to allot securities to third party & such third party offer all or any of those securities to public then the document by which securities are offered to public is treated as deemed prospectus
 - ★ All legal provision applicable to prospectus also applies to deemed prospectus
- (2) Presumption:- If any person accept that offer it will be treated as a subscriber
- (3) In the below 2 cases, allotment is presumed to have been made with a view of offering them to the public
 - (a) When all or any securities are offered by third person to public within 6 months after allotment or agreement to allotment
 - Or
 - (b) Date on which third party made offer to Public, whole consideration of securities was not received by the Co. from third person.
- (4) Two additional disclosures in addition to section 26
 - Net amount received or to be received by Co. from third party
 - Time & Place at which contract for allotment may be inspected
- (5) Section 26 apply as if persons making offer were named in prospectus as director of Co.
- (6) Signing → In case of Co. - by 2 directors of Co.
In case of Firm - by not less than one – half of partners

Matters to be stated in Prospectus [Section 26]

- (1) Applicable to Public Co.
- (2) Prospectus – Dated & Signed by every director, proposed director or his authorised attorney
- (3) Prospectus shall state Info & report on Financial Info as specified by SEBI in consultation with CG
- (4) Unit then Info & Report of Financial info mentioned in regulation made by SEBI under SEBI Act, 1992 shall apply
- (5) Prospectus can be issued on formation or subsequently
- (6) Co. to deliver prospectus to RoC on or before date of Publication
- (7) Date of publication = Date indicated in prospectus
- (8) Expert statement in Prospectus is allowed if
 - (a) Expert not involved in Formation/Promotion/Management of Co.
 - (b) Written Consent of Expert is taken
 - (c) Consent not withdrawn by Expert before delivery of Prospectus to ROC
 - (d) Prospectus must include the statement to this effect
- (9) Disclosure on face of every Prospectus :-
 - (1) Copy of Prospectus has been delivered to RoC for filing
 - (2) List of all documents attached with Prospectus
- (10)

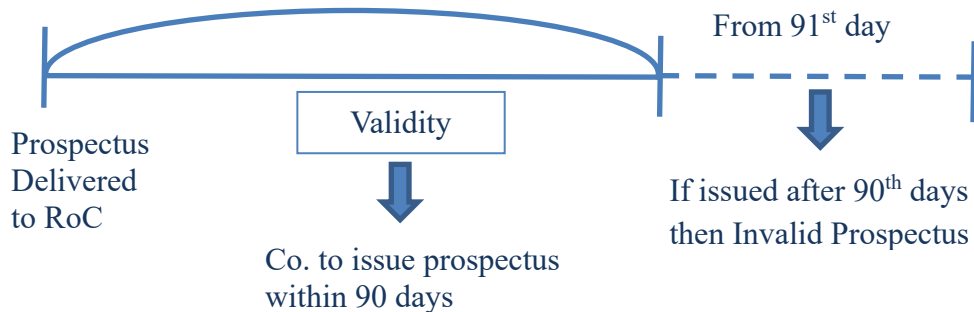

- (11) If prospectus contravenes Sec 26 :-
 - (a) Co. & Every person knowingly party to issue of prospectus ➔ Min 50 k – Max 3 lakhs

Variation in Terms of Contract or Objects Stated in Prospectus [Section 27]

- The terms of a contract or objects for which the prospectus has been issued can be way of **special resolution passed through postal ballot**.
- Details of the notice which has to be given to the shareholders are to be **published in 2 newspapers** (one English and one vernacular language) in Form **PAS-1** indicating clearly the justification for such variation.
- Advertisement shall be published simultaneously with dispatch of Postal Ballot Notices to Shareholders. The notice shall also be **placed on the website of the Co., if any**.

- Such Co. is not allowed to use any amount raised through prospectus for buying, trading or otherwise dealing in equity shares of any other listed Co.
- Dissenting shareholders shall be given an exit offer by promoters or controlling shareholders

Offer of Sale of Shares by Certain Members [Section 28]

- In consultation with board of directors, Members of a Co. may offer whole or part of their holding of shares to the public
- Document by which the offer of sale to the public is made shall be treated as prospectus issued by Co.
- The members whether individual or bodies corporate or both, whose shares are proposed to be offered to the public, shall collectively authorise the Co. to take all actions on their behalf for carrying out the transaction.
- They shall reimburse the Co. for all expenses made by it on this matter.
- The provisions of section 23 to 41 shall be applicable to an offer of sale referred to in section 28 except for
 - (a) minimum subscription
 - (b) minimum application value
 - (c) any statement to be made by the Board of directors in respect of the utilization of money; and
 - (d) any provision which cannot be compiled or gathered by the offer or, with detailed justifications for not being able to comply with such provisions.
- The prospectus issued under section 28 shall disclose the name of the person or persons or entity bearing the cost of making the offer of sale along with reasons.

Difference between Sec 28 (OFS) & Sec 25 (Deemed prospectus)

| Sec 28 (OFS) | Sec 25 (Deemed prospectus) |
|--|--|
| (1) It covers all the genuine case where members want to liquidate their holdings | (1) It covers cases where Co. wants to get rid of compliance of Prospectus |
| (2) This section only mention shares | (2) This section covers securities |
| (3) Co. sell the shares of existing members on behalf members by issuing offer for sale document which treated as deemed prospectus | (3) Third person sell the securities of Co. for raising money from public. |
| (4) Money received from such sale is given to those members whose shares are sold. Co. is only entitled to get reimbursement from those members. | (4) Co. indirectly received public money |

Securities in Demat form [Section 29]

1. Following Co. shall issue securities in Dematerialised form by complying with Depositories Act, 1996
 - a) Every Co. making Public Offer or
 - b) Co. as may be prescribed (i.e. Unlisted Public Companies)

Advertisement of Prospectus [Section 30]

Where an advertisement of any prospectus is published, it shall be necessary to mention following contents of its MOA:-

- (a) Objects
- (b) Liability of members
- (c) Amount of share capital of the Co.,
- (c) Names of the signatories to the memorandum,
- (d) Number of shares subscribed by the signatories, and
- (e) Capital structure of the Co.

Shelf Prospectus [Section 31]

Shelf Prospectus means prospectus through which one or more Public issues can be made over a certain period without the issue of a further prospectus.

- (1) Only those Co. can issue shelf prospectus which SEBI may Specify
- (2) Co. to file Shelf Prospectus with RoC at the stage of First offer of securities
- (3) Max validity Period of Shelf Prospectus = 1 Year
- (4) Validity start from date of opening of first offer of securities
- (5) In case of second or Subsequent offer
 - (a) No Further Prospectus is required
 - (b) Information memorandum (PAS-2) is required
 - (c) Content of Information Memorandum
 - (i) New Charges created
 - (ii) Change in financial position
 - (iii) Such other changes as maybe prescribed
- (6) Time limit for Filing Info Memorandum - Within 1 month prior to the issue of second/Subsequent offer
- (7) If Co. received any advance before change, intimate the change to applicants and if desires to withdraw their application then refund the advance money within 15 days
- (8) Shelf Prospectus + Info. Memorandum shall be deemed to be Prospectus

Red Herring Prospectus [Section 32]

- (1) Red herring Prospectus (RHP) means a prospectus which does not include complete particulars of quantum/price of Securities
- (2) Co. may issue RHP prior to issue of Final Prospectus
- (3) Co. to file RHP with RoC atleast 3 days prior to opening of subscription list & offer
- (4) Any variation in Red herring prospectus & final Prospectus shall be highlighted in the

- final prospectus
- (5) Upon the closing of Offer, Final Prospectus containing following details to be filed with ROC & SEBI
- (a) Total capital raised
 - (b) Closing price of securities
 - (c) Any other details not in RHP

Issue of Application form [Section 33]

- (1) Abridged Prospectus means a memorandum containing such salient features of a prospectus
- (2) Every application form for shares or debentures has to be accompanied with the abridged prospectus except :-
 - (a) When application form is issued in connection with a bona fide invitation to a person to enter into an underwriting agreement with respect to shares or debentures
 - (b) In relation to shares or debentures which were not offered to the public; or
 - (c) Where offer is made only to existing members of the Co.
- (3) On default, Co. is liable to penalty of Rs. 50,000 for each default

Criminal Liability for Mis-statements [Section 34]

- (1) If Prospectus includes any statement which is untrue or misleading or Inclusion or omission of any matter likely to mislead, every Person who authorises issue of Prospectus liable for punishment under Section 447
- (2) Exceptions:
 - (1) he proves that such statement or omission was immaterial or
 - (2) he had reasonable grounds to believe & did upto the time of issue of prospectus that
 - Statement was true or
 - Inclusion/omission was necessary

Civil Liability for Mis-statements [Section 35]

- (1) If subscriber has suffered any loss or damage as consequence of misstatement in prospectus then

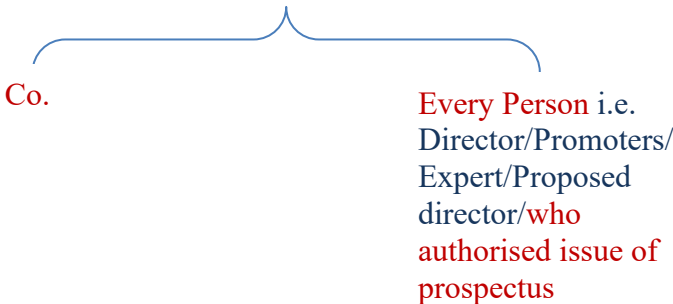

liable to pay the compensation to every person who suffered loss

(3) Above mentioned persons shall be **personally liable w/o any limitation on liability** if prospectus has been issued for any fraudulent purpose.

(4) Exceptions under section 35

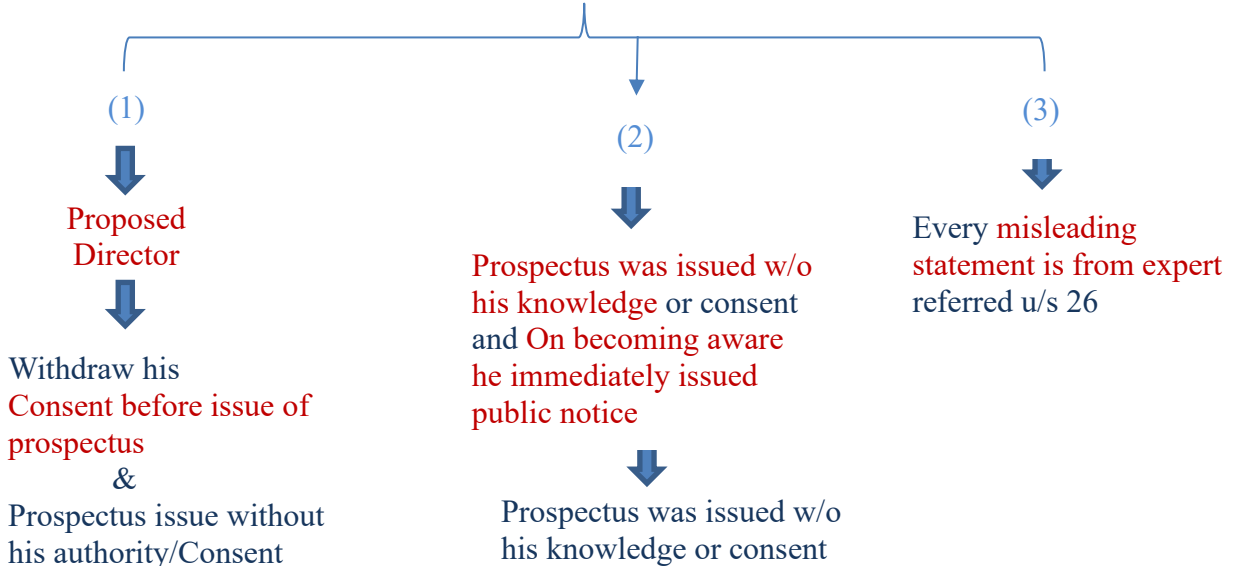

Punishment for Fraudulently Inducing Persons to Invest Money [Section 36]

Any person who, either knowingly or recklessly makes any statement, promise or forecast which is false, deceptive or misleading, or deliberately conceals any material facts, to induce another person to enter into, or to offer to enter into:

- (a) any agreement for, or with a view to, acquiring, disposing of, subscribing for, or underwriting securities; or
- (b) any agreement, the purpose or the pretended purpose of which is to secure a profit to any of the parties from the yield of securities or by reference to fluctuations in the value of securities; or
- (c) any agreement for, or with a view to obtaining credit facilities from any bank or financial institution,

shall be liable for action under section 447.

Action by Affected Persons [Section 37]

A suit may be filed or any other action may be taken under section 34 or section 35 or section 36 by:

- (a) Any person,
- (b) Group of persons or
- (c) Any association of persons

If affected by any misleading statement or the inclusion or omission of any matter in the prospectus.

Punishment for Personation for Acquisition, etc., of securities [Section 38]

Any person shall be liable for punishment under section 447, if:

- (a) He makes or abets the making of an application in a fictitious name to a Co. for acquiring, or subscribing for, its securities; or
- (b) He makes or abets the making of multiple applications in different names or different combinations of his name or surname for acquiring or subscribing for its securities; or
- (c) otherwise induces, directly or indirectly a Co. to allot or register any transfer of any securities to him or to any other person in a fictitious name.

Sub-section 2, provides that every Co. which issues a prospectus is required to reproduce prominently the provisions of the sub-section (1) in the prospectus and every form of application for securities.

Punishment for Fraud [Section 447]

| Amount and nature of fraud | Fine | | | Imprisonment | |
|--|--------------------------|----------------------------|--------|--------------|---------------|
| | Minimum | Maximum | | Minimum | Maximum |
| Fraud involving less than 10 lakh rupees or 10% of turnover, whichever is lower (public interest not involved) | – | Up to ₹ 50 lakh | or/and | – | Up to 5 years |
| Fraud involving at least 10 lakh rupees or 1% of turnover, whichever is lower (public interest not involved) | Equal to amount of fraud | 3 times of amount of fraud | And | 6 Months | 10 Years |
| Fraud in question involves public interest | Equal to amount of fraud | 3 times of amount of fraud | And | 3 Years | 10 Years |

Allotment of Securities [Section 39]

- (1) Securities to Public cannot be allotted unless:-
 - (i) Minimum Subscription mentioned in Prospectus has been subscribed and
 - (ii) Application money on such subscription has been received by the Co.
- (2) Amount payable on application shall not be less than 5% of the nominal amount of security
- (3) Whenever a Co. makes any allotment of securities, it shall file a return of allotment in form PAS -3 with RoC within 30 days
- (4) If Minimum Subscription not subscribed and Minimum Application money not received within the period specified therein
 - then repay application money within 15 days from closure of issue

- if not so repaid then directors who are officer in default shall jointly and severally liable to repay money with interest @ of 15 % p.a.
- (5) Refund money shall be credited only to the bank account from which the subscription was remitted.

Mandatory Listing [Section 40]

- (1) Every Co. before making public offer
 - must file Application with 1 RSE or More RSEs
 - obtain permission for securities to be dealt in such RSEs
 - (2) Prospectus to state the name or names of RSE in which the securities shall be dealt with
 - (3) All monies received from Public for subscription shall be kept in Separate Bank A/c in Scheduled Bank
 - (4) Such Money Can be utilised only for 2 Purposes: -
 - (1) Adjustment against allotment of Securities
 - (2) Repayment of Money, if unable to allot securities
 - (5) Payment of Underwriter Commission: -
 - (a) -Authorised by AOA
 - (b) - Source of Commission payment
 - (i) Proceeds of the issue
or
 - (ii) Profits of the Co.
or
 - (iii) Both
- (d) - Maximum Rate of Commission

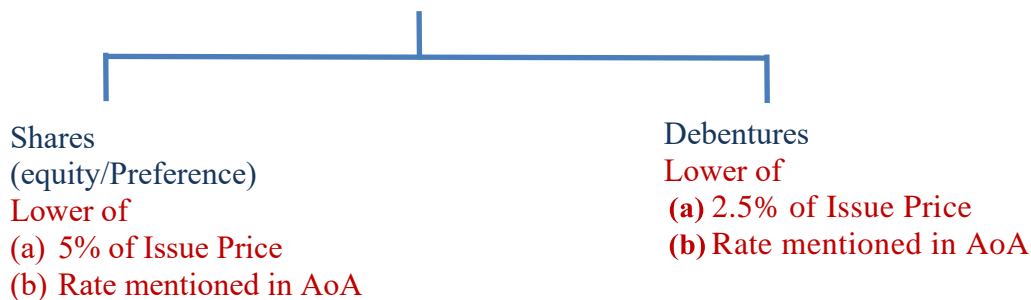

- (d) Filing of copy of underwriter contract for payment of commission with RoC at the time of delivery of Prospectus
- (e) Prospectus shall disclose
 - the name of the underwriters;
 - the rate and amount of the commission payable to the underwriter; and
 - the number of securities which is to be underwritten or subscribed by the underwriter absolutely or conditionally.

- (f) No commission shall be paid to any underwriter on securities, which are not offered to the public for subscription.
- (6) If default is made in complying with this section

| Defaulter | Minimum Fine | Maximum Fine |
|--------------------|--------------|--------------|
| Company | 5,00,000 | 50,00,000 |
| Defaulting Officer | 50,000 | 3,00,000 |

Global Depository Receipt [Section 41]

- (1) Co. may issue GDRs in any foreign country after passing a special resolution
- (2) GDRs can be issued by way of public offer or private placement
- (3) GDRs may be issued against issue of new shares or shares held by shareholders of the Co.
- (4) Shares shall be allotted in the name of the overseas depository bank
- (5) Until conversion of GDRs, the overseas depository shall be entitled to vote on behalf of the holders of GDRs
- (6) Only upon conversion of the depository receipts into underlying shares, holder of GDRs may become a member of the Co. and shall be entitled to vote

Private Placement [Section 42]

- (1) Section is applicable to both Public Co. & Private Co.
- (2) For making Private Placement (PP), Co. needs to comply all provisions of Sec 42
- (3) Applicable to Securities (Equity / Preference shares & Debentures)
- (4) Offer to Maximum 200 Identified Persons aggregate in FY
- (5) While computing limit of 200, Qualified Institutional Buyer (QIB) & Employees to whom securities are offered under ESOP are not Counted
- (6) Limit of 200 is security wise: -
 - for equity shares – 200
 - for Preference shares – 200
 - for Debentures - 200
- (7) Limit of 200 is not applicable to NBFCs & Housing Financing Co.



Follow RBI
Limit



National Housing
Bank Limit

- (8) If any private Co. is issuing shares under private placement, then remember maximum

number of members in a private Co. cannot exceed 200.

- (9) Co. makes PP to Unidentified Persons  Deemed Public offer
 or
 More than 200 persons

(10) For Private Placement offer

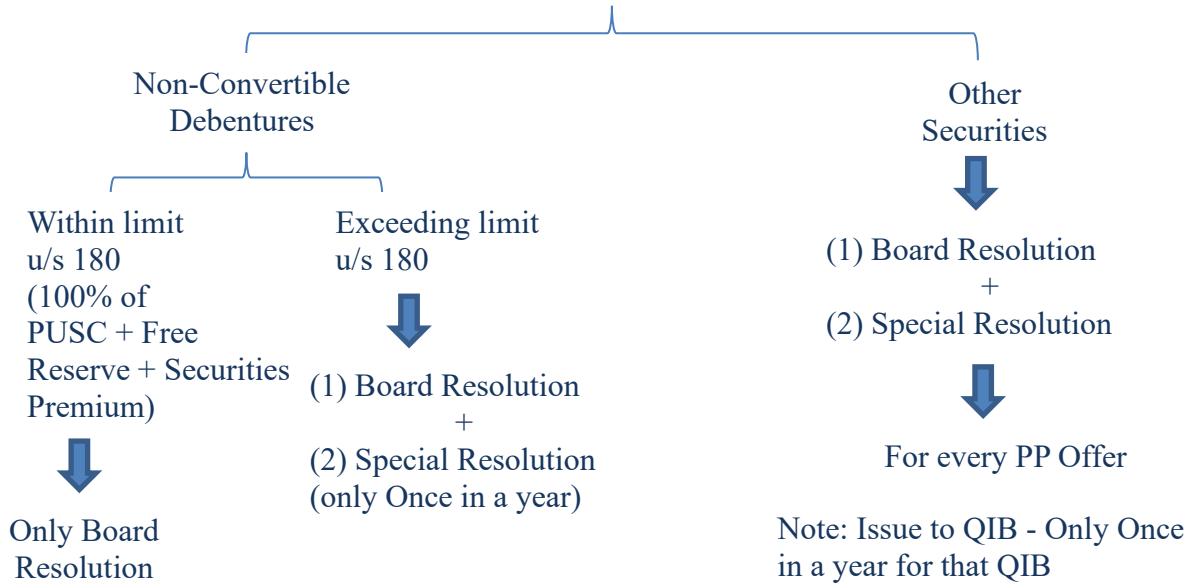

(11) **Content of Explanatory statement** annexed to notice given to Members for Special Revolution

- (a) **Particulars of offer**
- (b) **Date of passing of board Resolution**
- (c) **Kinds of Securities offered**
- (d) **Price** at which securities are offered
- (e) **Basis for price**
- (f) **Name & address of Valuation Expert**
- (g) **Total amount** to be raised

(12) When a Co. makes an offer or invitation to subscribe to securities, no offer or invitation of any securities shall be made to **a body corporate incorporated in, or a national of, a country which shares a land border with India** i.e. China, Bhutan, Nepal, Pakistan, Bangladesh, and Myanmar., unless such body corporate or the national, as the case may be, have **obtained Government approval under the FEMA Rules, 2019** and attached the same with the private placement offer cum application letter.

(13) Identified Persons **cannot pay consideration in cash**

(14) Money to be received from **applicants bank A/c only** However in case of Joint holder

money must be received from that person whose name appears first in the list

(15) **New Private Placement offer cannot be made by the Co. unless & until old Private Placement offer is completed or withdrawn.**

(16)

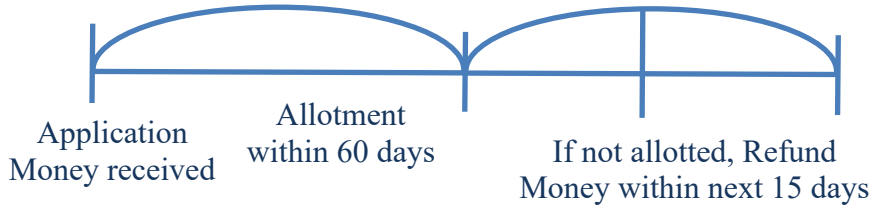

Note:- If money not refunded within 15 days, interest payable by Co. @12%p.a. from the expiry of the sixtieth day

(17) Money to be kept in **separate bank A/c of Scheduled bank** & can be utilised for 2 purposes only

(a) **Adjustment against allotment** of Securities or

(b) **Repayment of Money** to Subscribers if co. unable to allot securities

(18) No Co. making Private Placement can issue public advertisements

(19) **Return of Allotment (PAS – 3)** to be **filed with RoC within 15 days** from date of Allotment of Securities

(20) If Return of Allotment not filed - Co., its Promoters and directors for each default
Rs. 1000/day upto Maximum Rs. 25 Lakh

(21) Penalty for making offer or accepting money in contravention to section 42 :-

| Liabe | Nature of penalty | Description |
|-------------------------|--------------------------|---|
| Promoters and Directors | Fine | Amount raised through the private placement OR 2 crores rupees, whichever is lower |
| Company | Refund | All monies along with interest to subscribers within a period of thirty days of the order |

Important Definition

Prospectus means

- any document described or issued as a prospectus, and
- includes a **red herring prospectus** referred to in section 32, or **shelf prospectus** referred to in section 31,
- or any **notice, circular, advertisement** or other document **inviting offers** from the public for the subscription or purchase of any securities of a body corporate.

SHARE CAPITAL AND DEBENTURES

Kinds of Share Capital [Section 43]

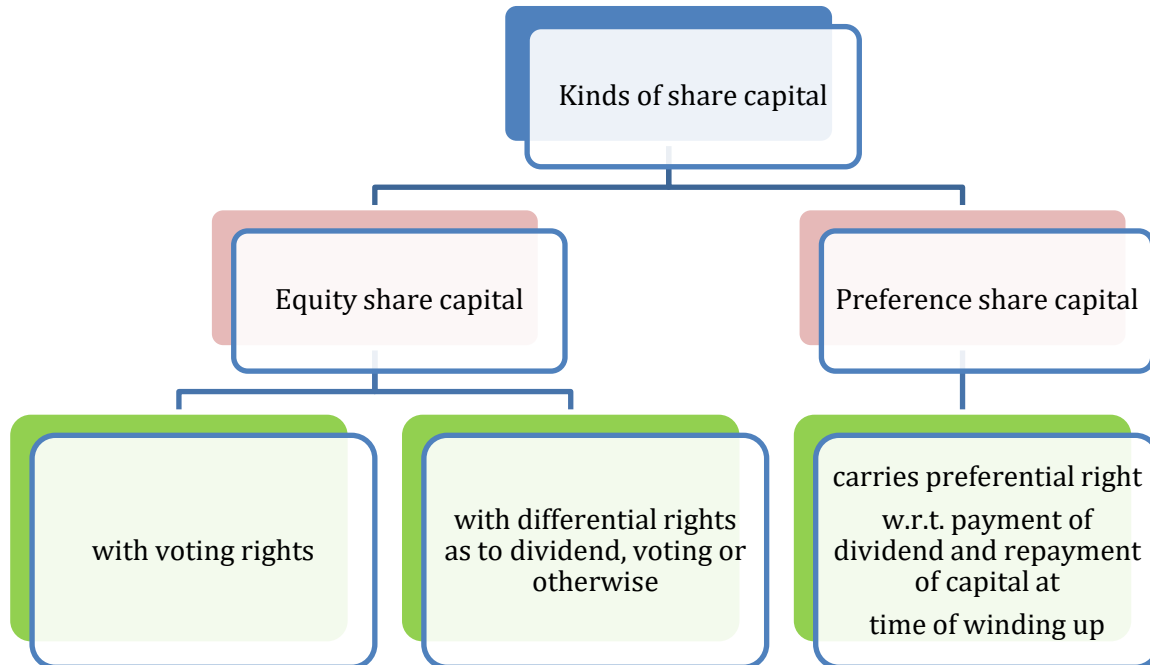

- (1) Equity share capital means share capital which is not preference share capital
- (2) Preference share capital ⇒ which carries preferential rights
 - (a) Payment of dividend before equity
 - &
 - (b) Repayment of capital before equity in case of winding up

Note : Preference share capital may or may not have preferential right for repayment of premium on redemption specified in MOA or AOA

Further preference share capital can be participatory or non-participatory.

- (a) After paying fixed dividend of preference share, they can still participate with equity share capital in surplus profits.
- (b) In case of winding up of Co., after repaying preference capital & equity capital, preference can participate with equity in surplus assets.

Rule 4 of Companies (Share Capital and Debentures) Rules 2014

- (1) Co. limited by shares may issue equity shares with differential rights if it complies following conditions:-
 - (a) Authorisation required in AOA of Co.
 - (b) Ordinary Resolution at General Meeting (through Postal ballot, in case of listed Co.)
 - (c) Voting power of shares with DVR ≤ 74% of Total Voting Power at any time

- (d) **3 Years**
 - (i) No default in filing of **FS and Annual Return**
 - (ii) **Not penalised** by Court/Tribunal under RBI Act, SEBI Act, SCRA, FEMA or any special Act.
 - (e) **5 years** – Not defaulted in Payment of
 - **dividend on Preference shares**
 - Interest or **term loan** repayment from PFI/ scheduled bank/State level FI
 - **Employee statutory dues** (e.g. :-PF/Gratuity)
 - Crediting amount in **IEPF**
 - (f) **No subsisting default in**
 - Payment of declared **dividend to shareholders**
 - Repayment of **matured deposits**
 - Redemption of **debentures/preference shares**
 - **Interest on above** deposits/debenture/payment of dividend.
2. Mandatory explanatory statement – with notice of GM/Postal ballot.
 3. Equity share with normal voting rights **cannot be converted** into equity shares of differential voting rights **or vice versa**.
 4. Mandatory **disclosure in Board Report** for the FY in which the issue of equity shares with differential rights was completed.
 5. Except for differential rights of equity shares, **all other rights of equity with DVR will be same** as of equity with normal voting rights.
 6. Specified **particulars to be maintained in Register of Members**.
- Note :- Section 43 shall not apply to Specified IFSC Public Co. and Private Co. where MOA or AOA of such Co. provides for it.*

Certificate of shares [Section 46]

(1)

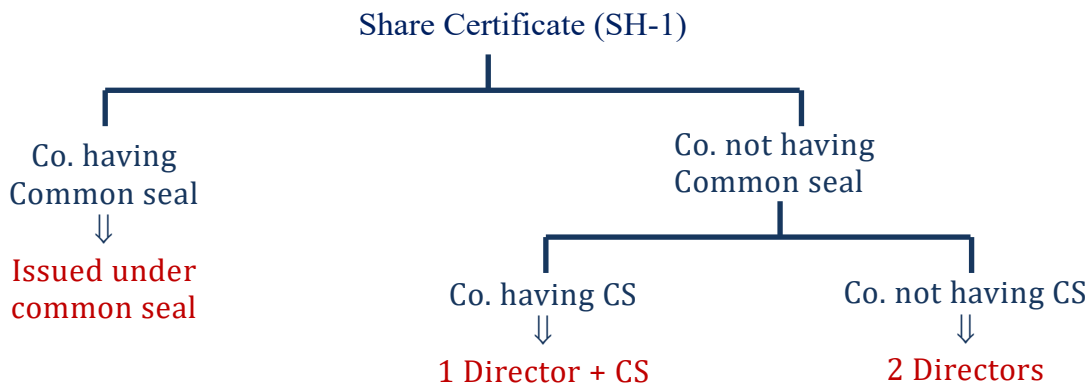

(2) Share certificate shall be **PRIMA FACIE** evidence of title of person to such shares

(3)

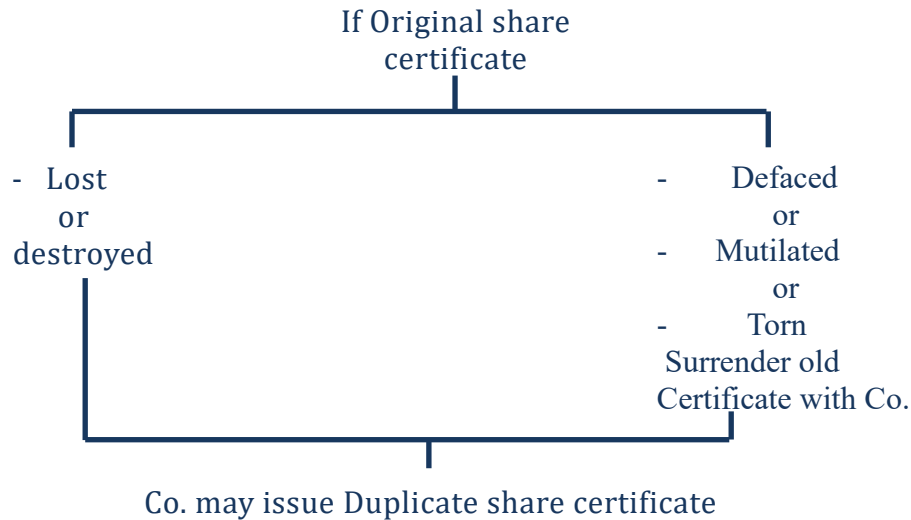

- (4) Above provisions not applicable, if shares are held in demat form.
- (5) **Record of depository is the prima facie evidence** of the interest of the beneficial owner, in case shares are held in demat form.
- (6) Co. shall issue only **one share certificate where shares are held by more than one person jointly with others**
- (7) Particulars of every **renewed and duplicate share certificates maintained in Form SH-2 with cross reference to register of members, in shape of register.**
- (8) **All entries** made in such register shall be **authenticated by the Co. secretary** or such other person as may be authorised by the Board.
- (9) Share Certificate shall be issued on surrender of letter of allotment or fractional coupons of requisite value (save in cases of issues against letters of acceptance or of renunciation, or in cases of issue of bonus shares); in pursuance of a resolution passed by the Board.
- (10) All blank forms to be used for issue of share certificates shall be printed and the printing shall be done only on the authority of a resolution of the Board and these shall be consecutively machine-numbered.
- (11) Such **forms shall be kept in the custody of the secretary** or such other person as the Board may authorise for the purpose.
- (12) All books pertain to record of share certificates shall be preserved in good order not less than thirty years and in case of disputed cases, shall be preserved permanently.
- (13) All certificates surrendered to a Co. shall immediately be defaced by stamping or printing the word **“cancelled” in bold letters** and may be destroyed after the expiry of three years from the date on which they are surrendered, under the authority of a resolution of the Board and in the presence of a person duly appointed by the Board in this behalf.

(14)

Punishment ⇒ Duplicate shares issued with intent to defraud

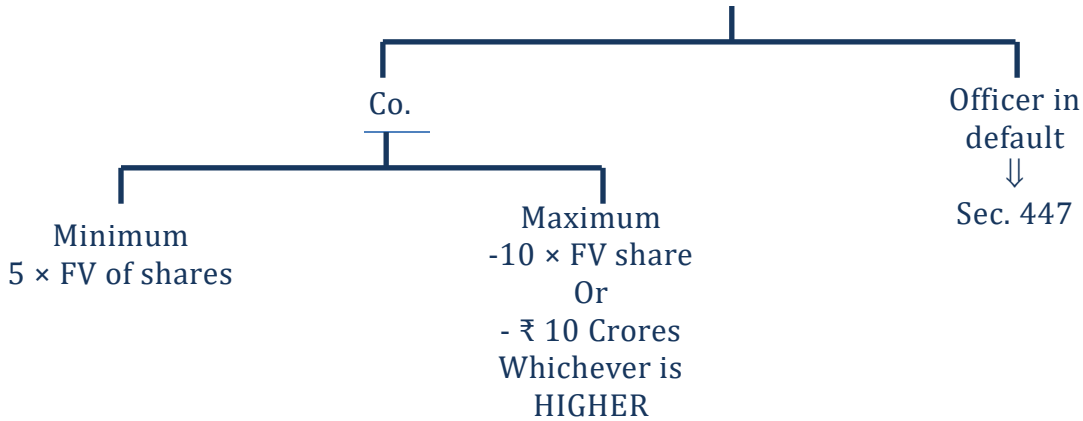

Voting Rights [Section 47]

Every Member of Co. limited by shares holding

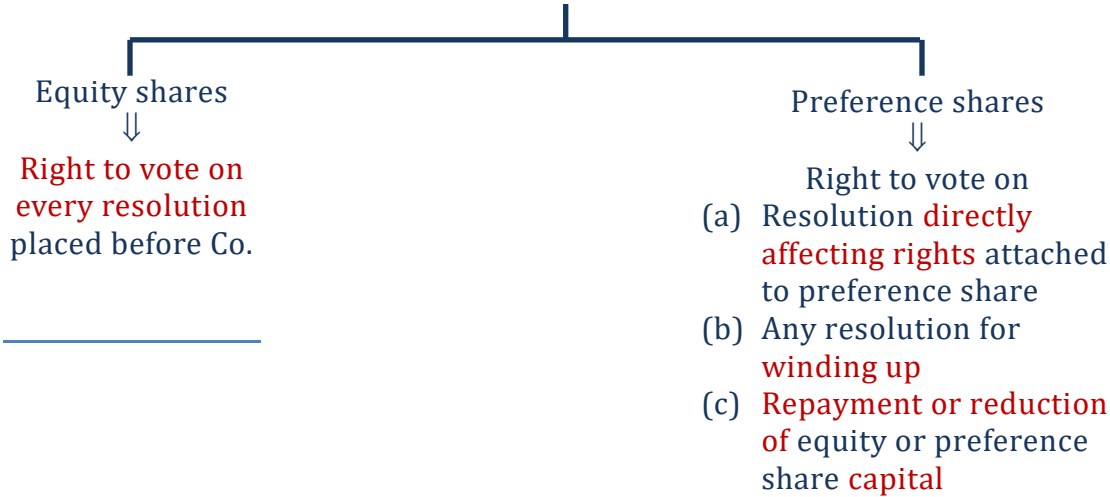

- (1) In case of poll, voting right shall be in proportion to his share in the paid up share capital of the Co.
- (2) If dividend on preference shares is not paid for 2 years or more, then Preference share holders get rights to vote on all Resolutions placed before the Co.

Note :- Section 47 shall not apply to Specified IFSC Public Co. and Private Co. where MOA or AOA of such Co. provides for it.

Variation of Shareholder's Rights [Section 48]

(1)

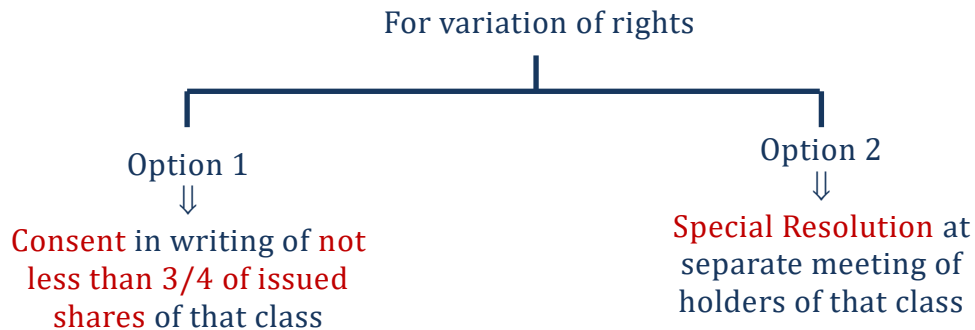

Note :- Such variation is permitted under AOA/MOA or
In absence of any provision, it is not prohibited by terms of issue.

(2) If variation of one class of shareholders rights affects any other class of shareholders, the consent of 3/4th of such other class shall also be obtained.

(3)

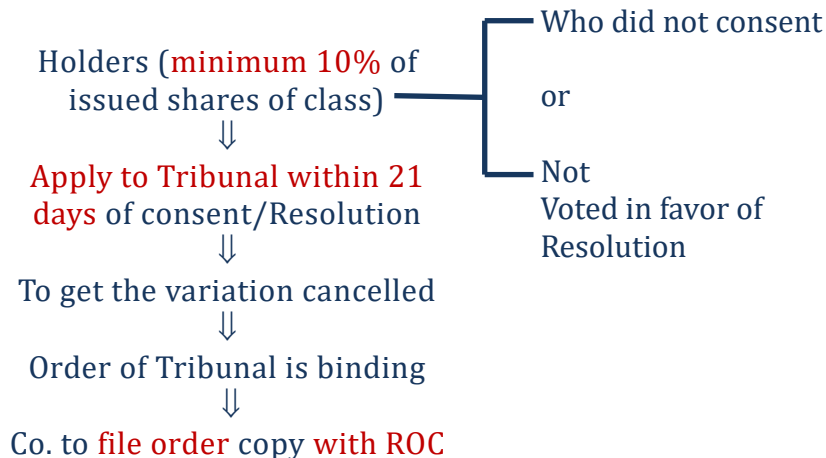

Calls on shares of same class on uniform basis [Section 49]

- (1) Calls on share of same class to be made on uniform basis for all the shares falling under that class
- (2) Usually share with same nominal value are considered as same class, but shares of the same nominal value on which different sums have been paid shall not be deemed, for this purpose, to fall under the same class.

Call in advance [Section 50]

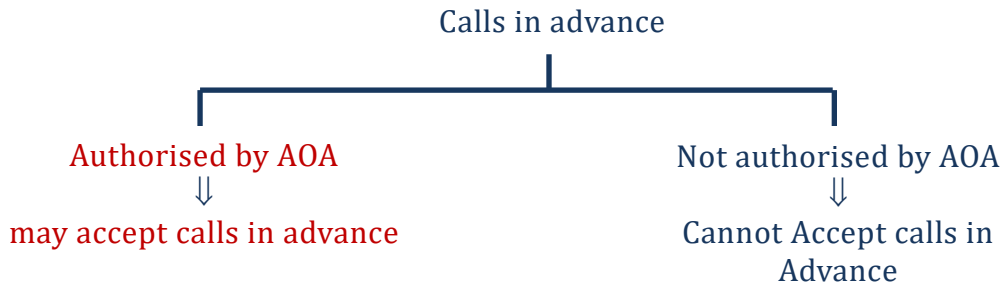

- ⇒ Member is **not entitled to any voting rights on call in advance** until its called up.
- ⇒ **Interest can be paid** on such advance, if permitted by AOA
- ⇒ Rate of interest can be changed by shareholders in GM

Payment of Dividend in proportion to amount paid up [Section 51]

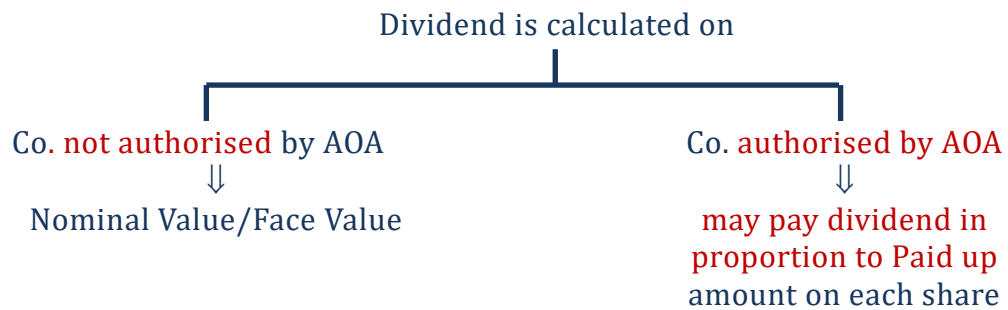

Application of Premium Received on Issue of shares [Section 52]

- (1) Premium received on shares shall be transferred to “Securities Premium Account.”
- (2) Premium may be received in **cash or in kind**

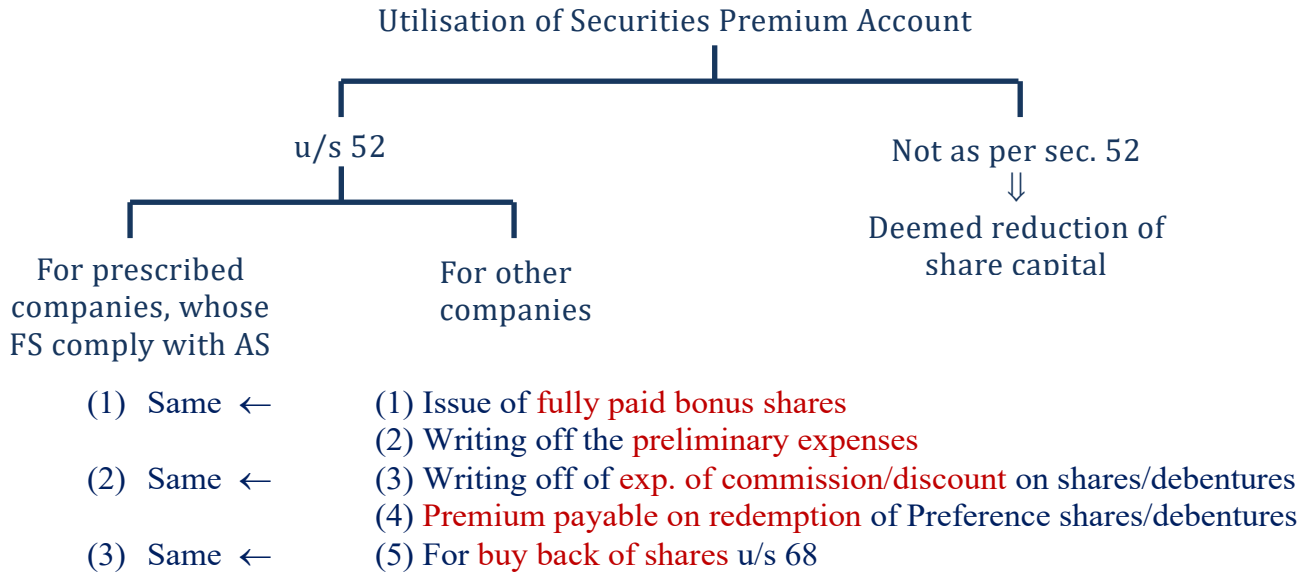

Prohibition on issue of shares at Discount [Section 53]

- (1) Co. shall **not issue shares** (equity/preference) **at discount** (i.e. less than face value). Any shares issued at discount is void.
- (2) **Exception** to above provision: -
 - (a) **Sweat equity shares** u/s 54
 - (b) debt conversion to share through
 - **Statutory Resolution plan**
 - **Debt Restructuring scheme in accordance with RBI Guidelines**

Note :- Debentures/Bonds can be issued at discount.

(3)

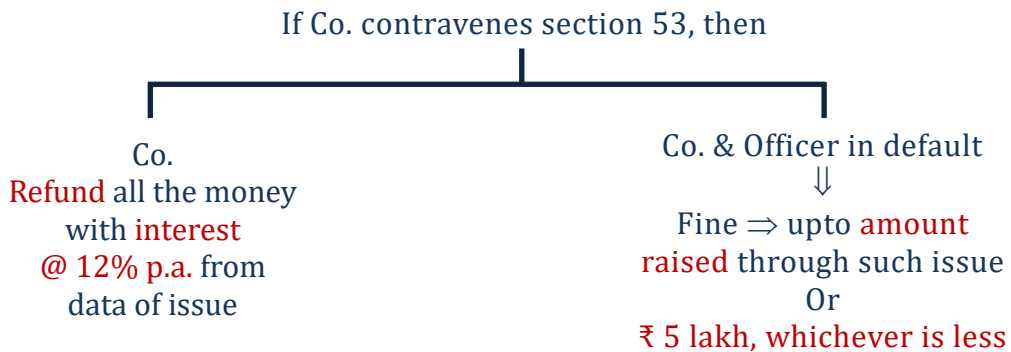

Issue of sweat equity shares [Section 54]

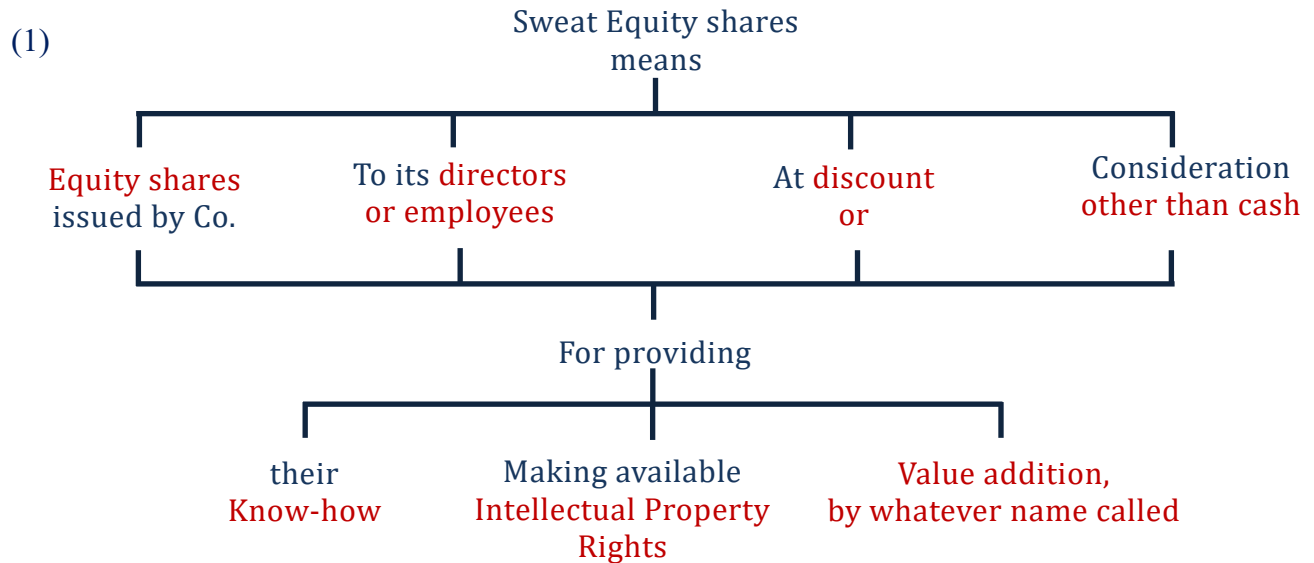

(2) Conditions to issue sweat equity shares

- (a) **Shares** of that class must be **already issued**
- (b) Issue is authorised by **special resolution**.
- (c) Resolution specifies
 - No. of shares
 - Current Market Price
 - Consideration, if any
 - Class or classes of director or employees to whom such equity shares are to be issued
- (d) For **Listed Co**, follow **SEBI Regulations**.
- (e) If **Other Co.**, comply **Rule 8** of Companies (Shares & debentures) Rules, 2014
 - (1) Employee means
 - (a) **Permanent employee of Co.** working in India /outside India.
 - (b) **Director of Co.**, whether whole time director or not
 - (c) Director/Employee of **Subsidiary (Inside/O/S India)** or its holding Co.
 - (2) SR is valid for making allotment **within 12 months from date of passing SR**
 - (3) The holders of sweat equity shares shall rank **pari-passu with other equity shareholders**.
 - (4) 'Value additions' means **actual or anticipated economic benefits** derived or to be derived by the Co. **from an expert or a professional** for providing know-how or making available rights in the nature of intellectual property rights, by such person to whom sweat equity is being issued **for which the consideration is not paid or included in the normal remuneration** payable under the contract of employment, in the case of an employee."

(3)

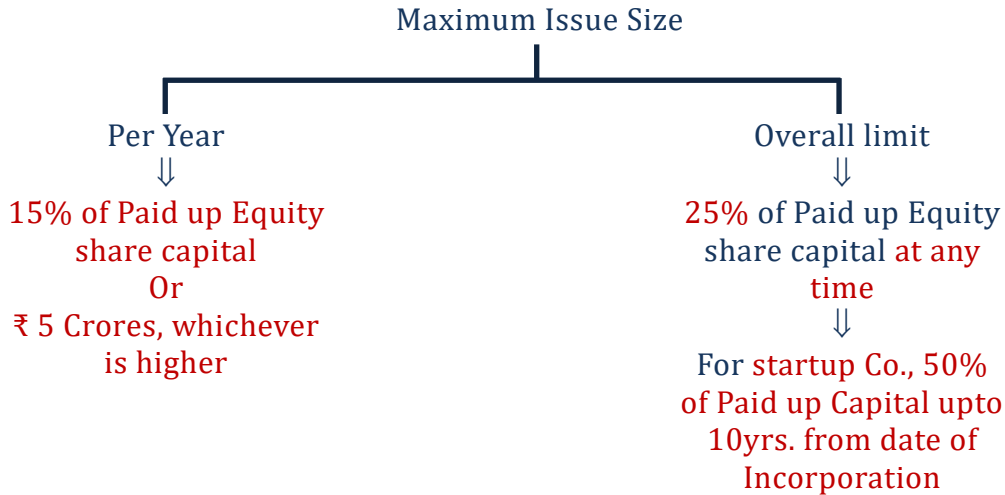

- (4) Locked in Period :- Non-transferable for 3 years from date of allotment
- (5) Issue price of sweat equity shares :- To be determined by Registered valuer
- (6) Valuation of IPR/Value Addition/know how- Determined by Registered Valuer

(7)

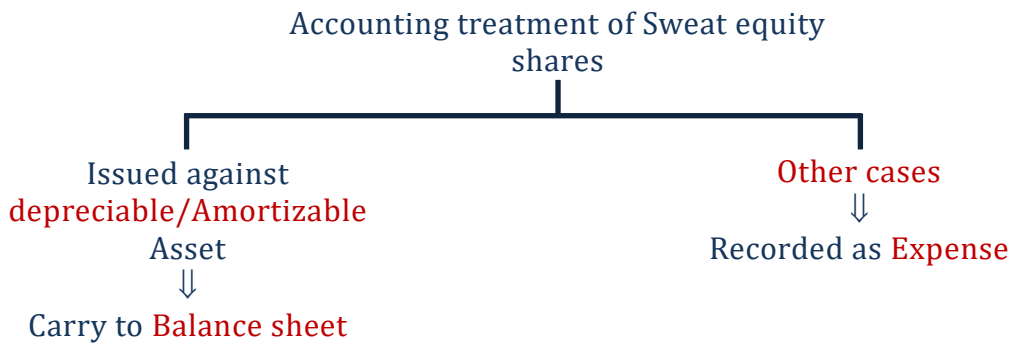

- (8) Co. to disclose details of such issue in Board Report
- (9) Co. to maintain Register of Sweat equity shares in Form No. SH. 3 at the registered office of the Co. or such other place as the Board may decide.

Issue & Redemption of Preference shares [Section 55]

- (1) Co. limited by shares shall not issue irredeemable preference shares
- (2) Co. limited by shares can issue redeemable preference shares if authorised by AoA.

(3)

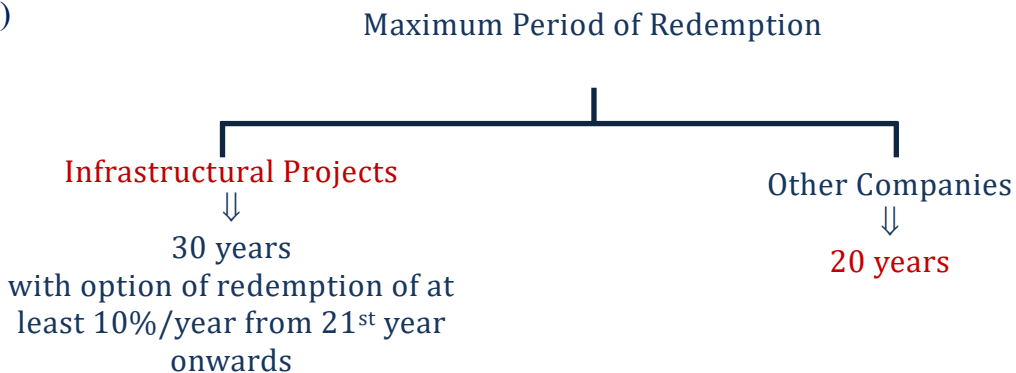

(4) Only **fully paid up preference shares can be redeemed**

(5) Source of redemption of Preference shares

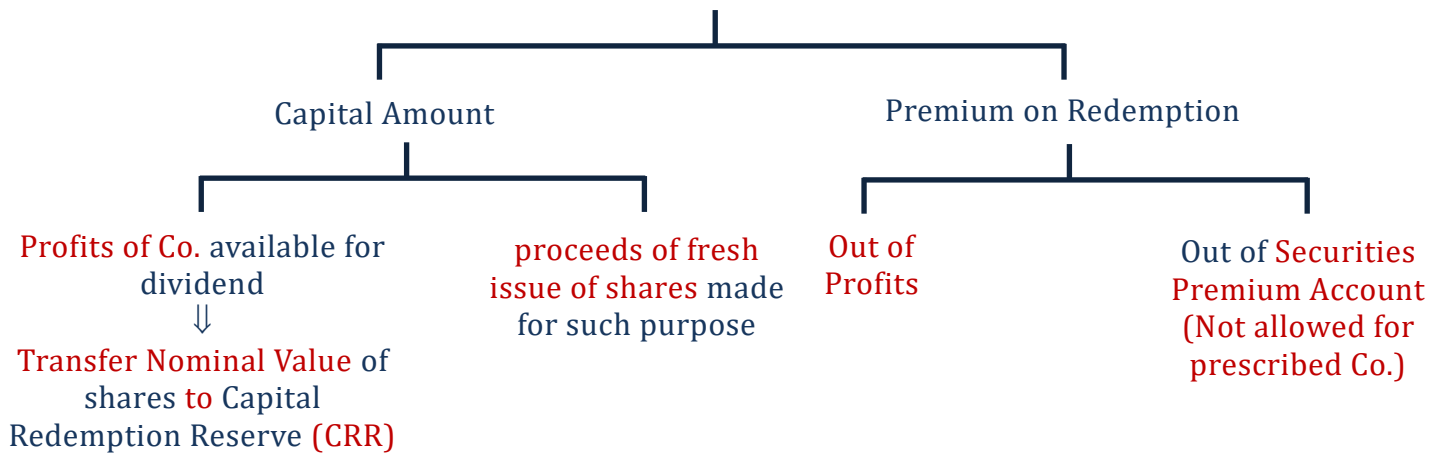

(6) CRR can only be used for issuing **fully paid bonus shares**

(7) Register of members to include particulars of preference shareholders

(8) Co. **not in position to redeem preference shares** or pay dividend

↓
Take **consent of 3/4th** in value of preference shares

↓
Approval of Tribunal on Petition

↓
Issue further redeemable preference shares of value existing preference shares + Dividend

↓
In this way the unredeemed preference shares shall be deemed to have been redeemed.

(9) Person who have **not consented to issue** of further preference shares

↓
Tribunal **order forthwith redemption** of preference shares **held by such persons.**

Alteration of share capital [Section 61]

(1) Alteration of share capital by limited Co. with a share capital

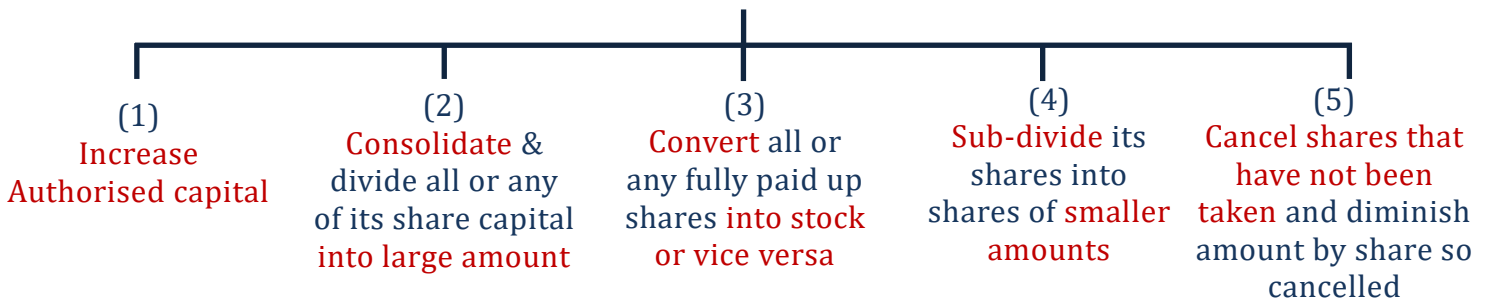

- (2) To alter share capital, **authority required in AOA**
- (3) **OR required** in GM.
- (4) **Cancellation under this section shall not deemed reduction of share capital.**
- (5) The proportion between the amount paid and unpaid (if any) on each reduced share shall be the same as it was in the case of the share from which the reduced share is derived.
- (6) Within 30 days of alteration, a notice must be given in Form SH-7 to the ROC

Further issue of share capital [Section 62]

- (1) Right issue
 - (a) **Offer of Equity/Preference shares to Equity shareholders in proportion of paid up share capital**
 - (b) Minimum period of offer \Rightarrow 15 days or prescribed (In rules – 7 days prescribed)
Maximum Period of offer \Rightarrow 30 days
 - (c) If **not accepted** within time \Rightarrow **deemed decline**
 - (d) Unless AOA provide otherwise, **offer include right to renounce**
 - (e) After expiry of time limit/receipt of intimation declining offer – **BOD to dispose** such shares **at its discretion in manner not disadvantageous to SH & Co.**
 - (f) Dispatch notice of right issue \Rightarrow **Minimum 3 days before opening of issue.**
 - (g) **In Private Co., if 90 % of the members gives consent, then less than 3 days acceptable**
- (2) Employee Stock Option Plan (ESOP)
 - (a) OR in case of Private Co./IFSC Public Co., **SR** in case of other companies
 - (b) **Minimum 1 year vesting period**
 - (c) Co. has **freedom to decide** exercise price, exercise period & lock-in period.
 - (d) Unless options are exercised:- No right to vote/dividend etc.
 - (e) Options are non-transferable
 - (f) Options cannot be pledged/hypothecated etc.
 - (g) No person other than employee entitled to ESOPs

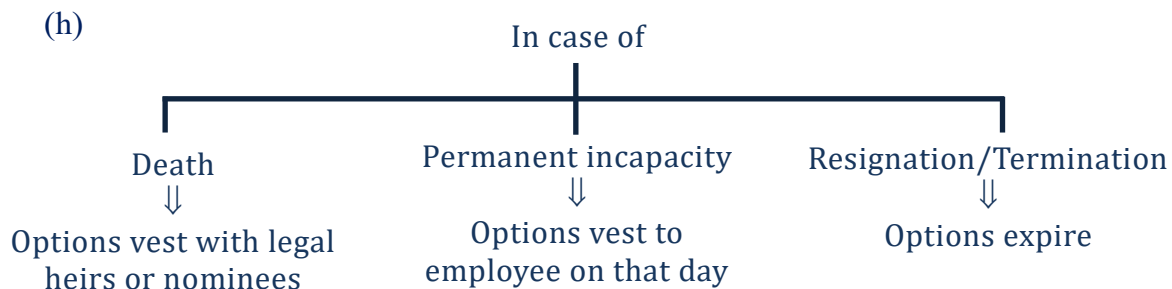

- (i) In case of **amalgamation/merger, period employed in previous Co. needs to be adjusted.**

- (3) Preferential allotment
 - (a) Offer to **any person**
 - (b) Authorised by **SR**
 - (c) Either for **cash or consideration other than cash**
 - (d) In case of non-cash consideration, Price to be determined by **Registered Valuer**

- (4) Not applicable, if subscribed capital is increased due to conversion of loan/debentures provided such issue was authorised by SR

Section 62 – Further issue of share capital

- (5) In public interest, Govt. can order conversion of debenture/loan from Govt. or part thereof into shares on terms decided by Govt., whether option for conversion is not included in terms of issue

⇒ Terms of conversion decided by Govt. having due regard to

- (1) Financial position
- (2) Terms of issue of debt
- (3) Rate of interest on debt/loan
- (4) Others

⇒ If terms of conversion not acceptable, Co. to apply to NCLT within 60 days from date of communication of order & NCLT to pass order as it may deem fit.

⇒ If Govt. order has the effect of increasing Authorised share capital

↓

MoA stands altered

↓

Authorised share capital increased

↓

Automatically by order.

Issue of Bonus shares [Section 63]

Issue of Bonus shares (Sec. 63)

Condition

Source

No defaulted

- | | | |
|--|--|---|
| <ul style="list-style-type: none"> (1) Authorised by AOA (2) Board Recommendation (3) OR in GM (4) Not in lieu of dividend (5) Once approved cannot be subsequently withdrawn (6) Partly paid up shares to be made fully paid up | <ul style="list-style-type: none"> (1) Free Reserves (2) Securities Premium Account (3) Capital Redemption Reserve A/c Except Revaluation Reserve | <ul style="list-style-type: none"> - Interest or Principal of fixed deposit/debt securities - Statutory dues of employees (Provident Fund/Gratuity/bonus) |
|--|--|---|

Notice to ROC for alteration of share capital [Section 64]

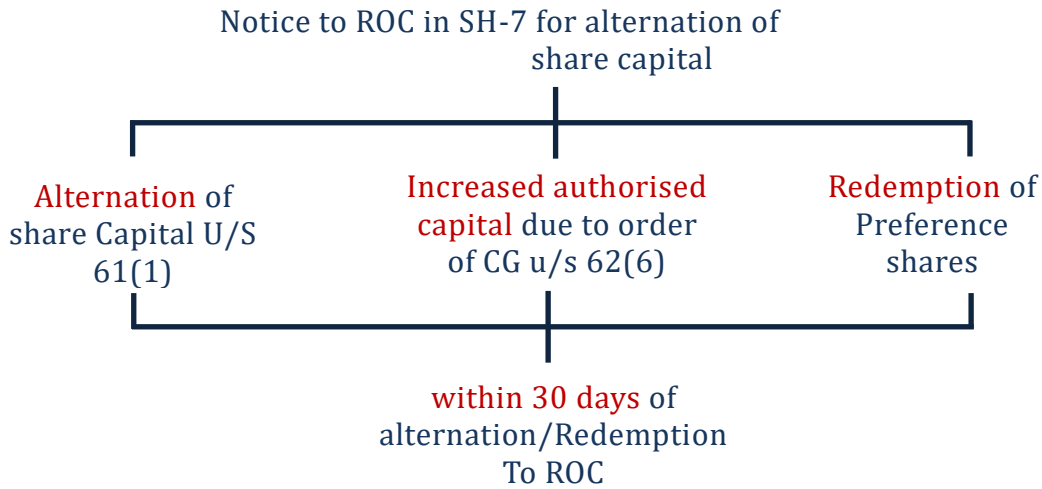

| Liabe | Penalty |
|--------------------------|------------------------------------|
| Co. | Rs. 500 /day - maximum Rs. 5 lakhs |
| Every officer in default | Rs. 500 /day - maximum Rs. 1 lakh |

Reduction of share capital [Section 66]

Manner of Capital Reduction :-

- (1) **Extinguish or reduce** the liability on any shares **not paid up**
- (2) With or without extinguishing or reducing
 - (a) **Cancel** any paid up share **capital which is lost** or not represented by Assets
 - (b) **Pay off** any paid up share capital which is in **excess of wants of Co.**
- (3) Nothing in this section shall apply to Buy-back(BB) of securities u/s 68.

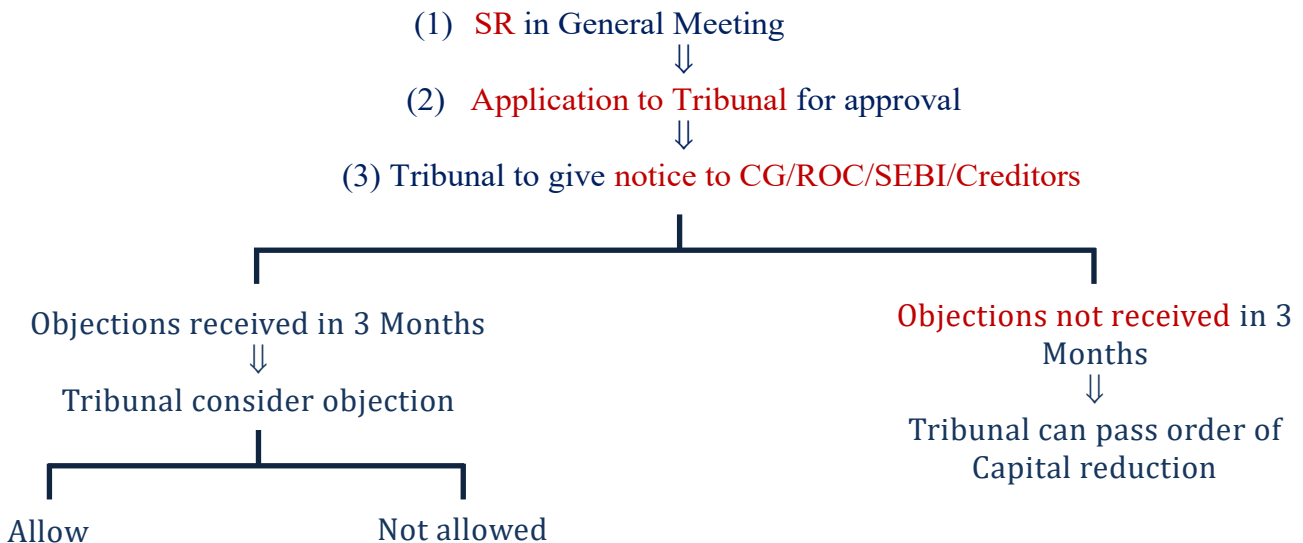

Before passing order, Tribunal to satisfy that–

- (a) The debt or claim of every creditor of the Co. has been either
 - (i) Discharged or
 - (ii) Determined or
 - (iii) Has been secured or
 - (iv) His consent is obtained.
- (b) The accounting treatment, proposed by the Co. for such reduction is in conformity with the accounting standards specified in Section 133 or any other provision of this Act. While making an application, a certificate to that effect by the Co.'s auditor has been filed with the Tribunal.
Within 30 days of the receipt of the copy of the Tribunal's order, the Co. shall deliver to the ROC, a certified copy of the tribunal order and minutes (containing special resolution) approved by the Tribunal showing;
 - (a) the amount of share capital;
 - (b) the number of shares into which it is to be divided;
 - (c) the amount of each share; and
 - (d) the amount, if any, at the date of registration deemed to be paid-up on each share,
- (4) Where the name of any creditor is not entered in the list of creditors and after reduction, Co. defaults in repayment of his debt.
 - (a) Every member on date of registration by ROC of reduction, liable to contribute to payment of that debt.
 - (b) If Co. is wound up, on application to Tribunal, settle a list of persons to contribute & enforce such calls on contributories as if they were ordinary contributories.
- (5) Officer of the Co. shall be liable for punishment under section 447, if he:
 - (a) Knowingly conceals the name of any creditor entitled to object to the reduction or abets or is privy to any such concealment; or
 - (b) Knowingly misrepresents the nature or amount of the debt or claim of any creditor or abets or is privy to any such misrepresentation.

Restrictions of Purchase by Co. or Giving of loans by it for purchase of shares [Section 67]

- (1) Co. having share capital cannot buy its own shares without consequent reduction in share capital
- (2) Public Co. cannot give Loan/guarantee/financial assistance for purchase of subscription of its shares or its holding Co.

Exception :-

- (1) Lending of money by banking Co. as in the ordinary course of its business
- (2) Scheme approved by Co. through SR, shares are held by Trustee for benefit of Employees or held by Employees.
- (3) Loan to employees other than director or KMP for an amount <6M salary for subscribing fully paid up shares in Co. or its holding Co. and to hold them by way of beneficial ownership.

Power of Co. to purchase its own securities [Section 68]

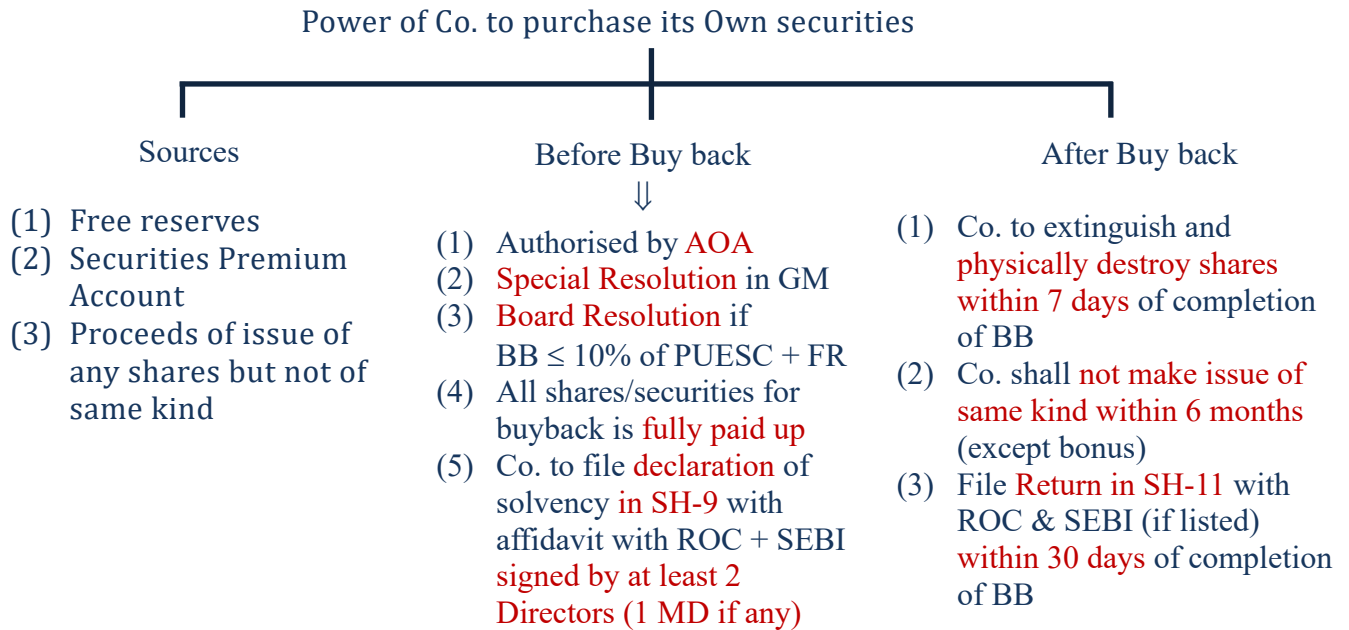

Limit size of Buyback

- (1) $BB \leq 25\%$ of Paidup capital + FR
* BB of equity ≤ 25% of PUESC
- (2) Ratio Post Buyback $\Rightarrow \frac{\text{Debt (secured \& unsecured)}}{\text{Paidup capital+FR}} \leq 2$
- (3) BB may be from
 - (1) Existing Shareholder on proportionate Basis
 - (2) Open Market
 - (3) Securities issued to Employee (ESOP or Sweat equity shares)

| Liabe | Minimum Fine | Maximum Fine |
|--|---------------------|-----------------------|
| Co. | One lakh rupee | Upto three lakh rupee |
| Every officer of the Co. who is in default | | |

Transfer of Certain sum to Capital Redemption Reserve Account [Section 69]

- (1) Where Co. purchases its own shares out of
 - (a) **Free reserves**
 - Or
 - (b) **Securities Premium Account**
 Then sum equal to nominal value of shares so purchased shall be transferred to **Capital Redemption Reserve**
- (2) Details of such transfer shall be disclosed in the balance sheet.
- (3) Utilisation of CRR \Rightarrow Issue of fully paid up bonus shares

Prohibition for buy-back in certain circumstances [Section 70]

(1) No Co. shall directly or indirectly purchase its own shares or other specified security

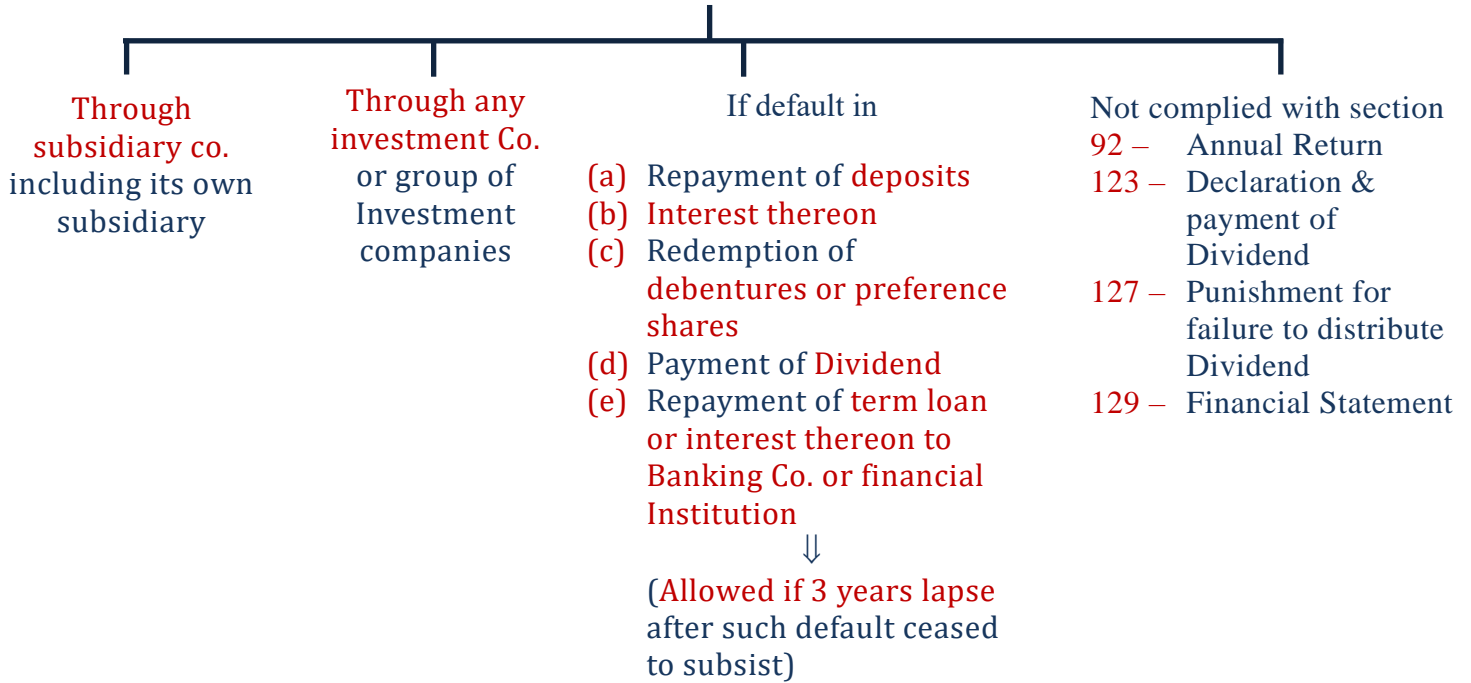

Transfer and Transmission of Securities [Section 56]

| Transfer of securities | Transmission of securities |
|---|--|
| <ul style="list-style-type: none"> (1) Voluntary (2) Transfer Instrument Required (3) Consideration may be present | <ul style="list-style-type: none"> (1) Operation of Law (2) Intimation of Transmission is required (3) No Consideration |

(1) Co. shall not register transfer of securities

or

interest of member in case of Co. not having share capital unless

- (a) Instrument of transfer in Form SH-4 is duly stamped, dated & executed by Transferor & Transferee
 - (b) Instrument specifies the name, address and occupation, if any of Transferee.
 - (c) Instrument is delivered to the Co. within 60 days of execution.
 - (d) Instrument shall accompanied with securities certificate or If security certificate is not in existence then letter of allotment of securities to be filed
- (2) If instrument of transfer is lost or not been delivered to Co. within prescribed time, Co. may register the transfer on such terms as to indemnity as Board may think fit.

- (3) Instrument of transfer shall not be required
 - For transfer of **bonds issued by Govt. Co.**
 - **Intimation by Transferee** required specifying

name

 +

address

 +

occupation

 +
Bond certificate/Letter of Allotment
- (4) For registering transmission of Securities, intimation of transmission is required instead of instrument of transfer.
- (5) **Cases of transmission**
 - (1) **Death** ⇒ To legal Representative
 - (2) **Insolvency** ⇒ To resolution professional
 - (3) **Lunacy** ⇒ To administrator appointed by Court
- (6) Case of Partly paid up shares
 If **application is made by Transferor** alone & shares are partly paid up, Co. to give **notice in SH-5 to Transferee**
 ↓
 Transferee to give **no objection within 2 weeks** of receipt.
 ↓
After that Co. to register transfer
- (7) Timeline for delivery of Security Certificate by Co.

| Case | Maximum Limit |
|---|---|
| Subscriber to MoA | Within 2 Months of incorporation |
| Allotment of shares | Within 2 Months of allotment |
| Allotment of debentures | Within 6 months from date of allotment |
| Transfer/Transmission of securities | Within 1 month from date of receipt of transfer instrument or intimation of transmission |
| securities by specified IFSC public and private Co. | Within a period of 60 days after incorporation, allotment, transfer or transmission. |

- (8) **Legal Representative** can transfer the securities of deceased person **without becoming a holder & transfer will be valid** as if he had been the holder at the time of execution of transfer instrument.
- (9) Default compliance of above provision, Co. & Officer in default = ₹ 50000
- (10) Where any depository or depository participant transferred shares with an intention to defraud a person ⇒ **Liable under section 447**
- (11) Forgery
 - (a) **Forged transfer is a nullity**
 - (b) It does not give Transferee any title to shares
 - (c) **Co. is bound to restore the name of real owner** and pay him dividend which he ought

to have received

Punishment for personation of Shareholders [Section 57]

If any person deceitfully personates, as an owner

- (a) of any security or
- (b) interest in a Co., or
- (c) as an owner of any share warrant or coupon &

Obtains or attempt to obtains any such security or interest or share warrant or coupon or any money due to any such owner,

He shall be punishable with

Imprisonment – 1 year to 3 years

And

Fine - ₹ 1 lakh to ₹ 5 lakh

Refusal of registration and appeal against refusal [Section 58]

(1)

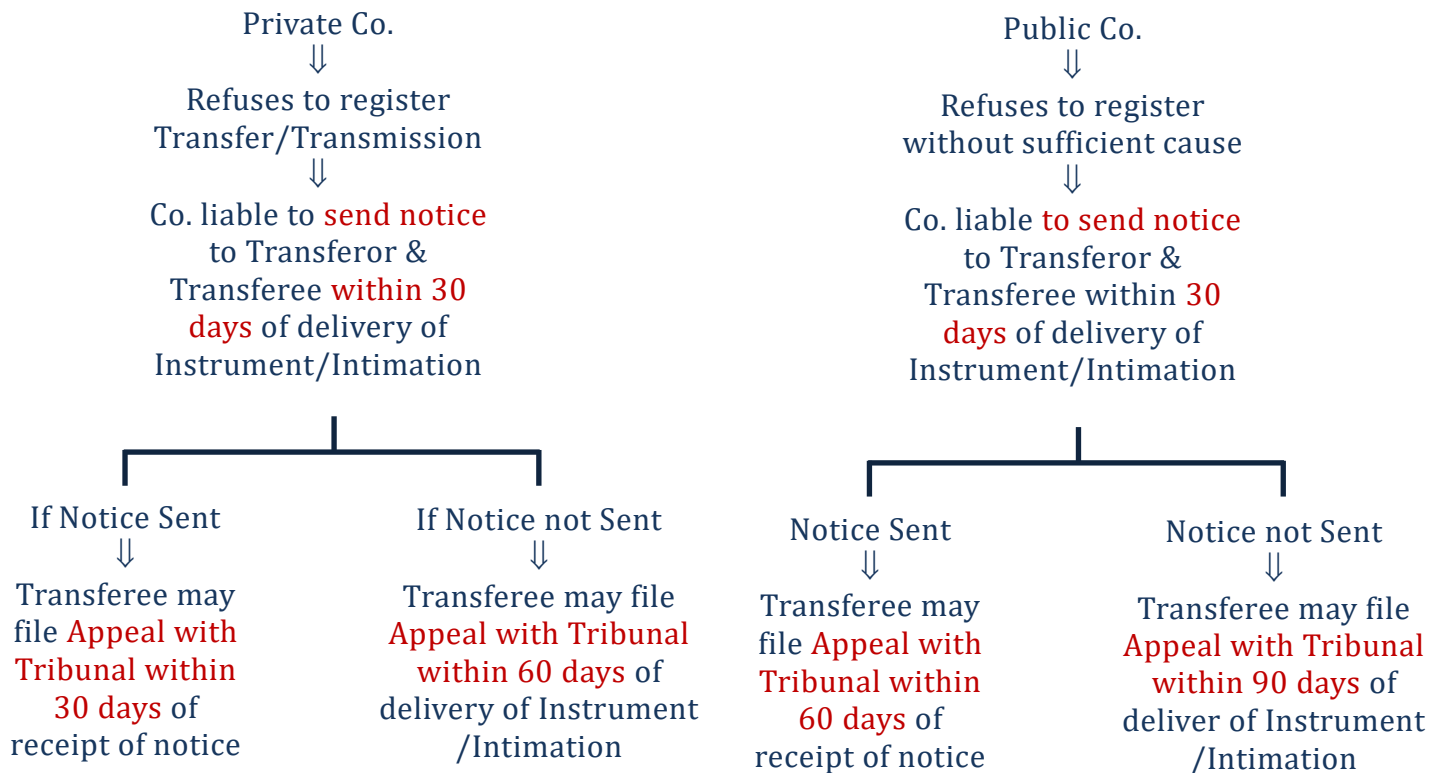

(2) After hearing parties, Tribunal may either

- Dismiss the appeal

or

- Order :-

- (a) Direct Co. to register Transfer/Transmission & Co. to comply within 10 days of receipt of notice.

Or

(b) Direct rectification of register & direct the Co. to pay damages to aggrieved party.

- (3) If person contravenes order of tribunal-
 Imprisonment – 1 years – 3 years
 And
 Fine – Rs. 1 lakh – 5 lakhs

Rectification of Register of Members [Section 59]

- (1) If **without sufficient cause**, the name of any person is
- (a) entered **in Register of Members**
 - (b) **Omitted** from Register of Members
 - (c) **Unnecessary delay** in entering/removing name
 then **any aggrieved person or member or Co. can make application to**
 - (a) Tribunal

Or

 - (b) Competent court outside India (In case of foreign member of Debenture holder outside India)
 for rectification of Register of Members
- (2) After hearing parties, Tribunal may either
- **Dismiss the appeal**
- Or
- **Order**
 - (a) Direct Co. to register Transfer/Transmission & Co. to comply within 10 days of receipt of notice.

Or

 - (b) Direct rectification of depository's records or register & direct the Co. to pay damages to aggrieved party.

Debenture [Section 71]

| | |
|--|--|
| <p style="text-align: center;">Section 2(30) Debenture Includes - Debenture stock - Bonds - Any other instrument of a Co. evidencing a debt Whether constituting a charge on the assets of the Co. or not</p> | <p style="text-align: center;">Debenture Excludes Instruments referred to in Chapter III-D of the Reserve Bank of India Act, 1934 and Such other instrument, as may be prescribed by the Central Government</p> |
|--|--|

- (1) Issue of **convertible (wholly/partly) debentures** shall be **approved by SR** passed at General Meeting.
- (2) Co. **cannot issue debentures carrying voting rights.**

- (3) Issue of secured debentures
- (a) **Maximum Redemption period – 10 years**
 - (b) For **specified Co. ⇒ 30 years**
 - (i) Co. engaged in setting up infra projects
 - (ii) Infra finance Co.
 - (iii) Infra debt fund NBFC
 - (iv) Co. permitted by CG/RBI/National Housing Bank/other statutory authority
 - (c) Creation of charge
 - (i) Issue of debentures shall be secured by creation of **charge on properties or assets of CASH**
 - (ii) Having **value which is sufficient** for due repayment of **debenture amount & interest thereon.**
 - (d) Appointment of debenture Trustee
 - (i) Co. shall **appoint debenture Trustee**
 - (ii) before issue of prospectus/letter of offer
 - (iii) Execute debentures trustee deed in **Form SH-12 within three months of closure of the issue or offer.**
- (4) Debenture Trustee
- (a) If offer to **public or member >500**, the Co. must appoint one or more **debenture trustees** before issue of prospectus.
 - (b) Name of Debenture Trustee to be stated in prospectus or letter of offer and in subsequent communications.
 - (c) Before appointment, **written consent of Debenture Trustee to be obtained AND** statement to that effect included in letter of offer
 - (d) Board will **fill casual vacancy** in office of Trustee
 - (e) In case of Resignation of debenture Trustee, obtain written consent of majority of Debenture holder prior to filing vacancy.
 - (f) Debenture Trustee may be **removed if approved by not less than 3/4th in value of Debenture holders.**
- (5) Eligibility to become Debenture Trustee
A person shall not be appointed as Debenture Trustee if he
- **Beneficially hold shares** in Co.
 - is **promoter, director, KMP, other officer, employee of CASH**
 - **beneficially entitled to money to be paid by Co. other than remuneration** as Debenture Trustee.
 - **indebted to CASH** or subsidiary of such holding Co.
 - **Furnished guarantee** in respect of principal debt secured by debentures.
 - **Relative of promoter or director or KMP** of the Co.
 - Has **pecuniary relation with Co.**
ceiling ⇒ Lower of (2% of Gross T/O or Total Income or ₹ 50 Lakh or higher amount as may be prescribed) in preceding 2 FY or CY
- (6) Debenture Trustee shall take **steps to protect the interest of the debenture holders** and redress their grievances as per Rules.
- (7) Meeting of Debenture holders convened by Debenture Trustee if:-
- (a) **requisition in writing** signed by Debenture holders holding $\geq 1/10^{\text{th}}$ of value of outstanding debentures.

or

- (b) happening of any event, which constitute breach, default or which in the opinion of Debenture Trustee affects interest of Debenture holders.
- (8) Any provision in trust deed exempting debenture Trustee from liability for breach of trust or indemnifying him shall be void.
- (9) However, **Liability of Debenture Trustee shall be subject to exemption as agreed by Majority of Debenture holders + holding more than 3/4th in value of total debentures.**
- (10) Co. shall pay interest & redeem debentures as per terms & Conditions of their issue.
- (11) Contract with Co. to take up & pay for any debentures of Co. may be enforced by a decree for specific performance.
- (12) Co. to **obtain special resolution if borrowings exceeds 100% PUSC + FR + SPA**
- (13) Co. to file **return of allotment in form PAS-3 within 30 days** of allotment of such debentures.
- (14)

| | |
|--|---|
| <p>At any time, If Debenture Trustee comes to Conclusion that Assets of Co. are insufficient /Likely to become insufficient to discharge principal amount when due Debenture Trustee may file petition before Tribunal</p> <p style="text-align: center;">↓</p> <p>After hearing, Tribunal may impose restrictions on incurring further liability of Co.</p> | <p>If Co. fails to redeem debentures on date of maturity or fail to pay interest when due</p> <p style="text-align: center;">↓</p> <p>On application of Debenture holders or Debenture Trustee, Tribunal may order Co. to redeem it fort with with payment of principal and interest thereon.</p> |
|--|---|

| Type of Co. | DRR | DRI |
|-------------------------------|------------|------------|
| (1) Listed Co. | Nil | Nil |
| (1) AIFI + Banks | Nil | Nil |
| (2) PFIs | Nil | 15% |
| (3) Other listed Companies | Nil | 15% |
| (a) Public Issue | Nil | Nil |
| - NBFC + Housing finance Co. | | |
| - Other listed companies | | |
| (b) Private Placement | | |
| (2) Unlisted Co. | Nil | Nil |
| (1) AIFI + Banks | Nil | Nil |
| (2) PFIs | Nil | Nil |
| (3) Other Unlisted companies | 10% | 15% |
| (a) NBFC + Hawing finance Co. | | |
| (b) Other unlisted Co. | | |

ACCEPTANCE OF DEPOSITS BY CO.

Acceptance of Deposits by Co.

| Particulars | Public Co. | | Private Co. |
|---|--------------|------------------|-------------|
| | Eligible Co. | Non Eligible Co. | |
| Deposit From Members | ✓ | ✓ | ✓ |
| Deposit From Public (Other than public) | ✓ | × | × |

Deposits [Section 2(31)]

What is Deposits?

Includes any receipt of money by way of deposit or loan or any form by a Co.

But does not include such amount as prescribed in consultation with RBI

Amounts not Considered as Deposits

1. **Amount from government or statutory authority**
 - Amount received from CG/SG/Local authority/statutory authority constituted under Act of Parliament or state legislature
 - Amount from other source whose repayment is guaranteed by CG/SG
2. **Amount from Foreign**
 - Amount received from foreign Govt, foreign or international banks, multi-lateral financial institutions, foreign body corporates, foreign citizens, foreign collaborators, foreign export credit agencies, PROI etc. as per FEMA
3. **Loan from Banks**
Amount as loan or facility from
 - banking Co.
 - SBI or its subsidiary banks
 - Notified banking institution
 - Any Co-operative bank
4. **Loan from PFI**
Amount received as a loan or financial assistance from Public Financial Institution (PFI) or regional financial institutions or insurance companies or scheduled banks

5. **Amount received from AIFs/VC/REIT/InvITs/Mutual funds**
Alternate Investment funds, Domestic Venture Capital funds/ Infrastructure Investment Trusts / Real Estate Investment Trusts/Mutual funds
6. **Commercial papers and RBI instruments**
Amount received against Commercial paper or any other instruments in accordance with RBI guidelines
7. **Subscription for Securities**
Amount received towards subscription to any Securities

Note:-

- If securities are not allotted within 60 days then amount needs to be refunded within 15 days from completion of 60 days, otherwise such amount shall be treated as deposits
 - Any adjustment of amount for any other purpose shall not be treated as refund
8. **Secured Bonds/Secured Debentures**
Amount raised by issue of bonds or debentures secured by first charge or Charge ranking pari passu with first charge on assets excluding intangible assets.
 9. **Compulsory Convertible bonds/ debentures within 10 Years**
 10. **Non-Convertible debentures not constituting charge on assets of Co. and listed on recognised stock exchange as per SEBI regulations**
 11. **Director**
 - In case of Public Co., amount received from Director of Co.
 - In case of Private Co., amount received from Director or relative of director of Co.
 - Declaration in writing from person whom money is received that amount given to the Co. is not out of funds acquired by him by borrowing or loan or deposits from others.
 - Co. shall disclose details of money so accepted in Board report.
 12. **Employee**
Amount received from employee of Co. not exceeding annual salary under contract of employment in the nature of non-interest bearing Security deposit.
 13. **Promoters due to stipulation**
 - Unsecured loan given by promoters or their relatives or both
 - due to stipulation imposed by lending institution or bank on promoters to contribute such finance
 - Exemption available only till loan of financial institution or bank is repaid
 14. **Nidhi Co.**
 - Any amount accepted by Nidhi Co. in accordance with rules made under section 406 of the Act
 15. **Chit funds**
 - Any amount received by subscription of Chit under Chit Fund Act, 1982
 16. **Collective Investment Scheme**
Any amount received under Collective Investment Scheme in compliance with SEBI regulations
 17. **Any amount received by Co. from any other Co.**
 18. **Startup Private Co.**
Amount of ₹ 25 lakh or more received by startup private Co.
 - in Single tranche
 - from a person
 - by way of Convertible Note (Convertible into equity shares or repayable within period

not exceeding 10 years from date of issue of convertible notes)

19. Non-interest bearing amount received or held in trust.
20. Amount received in course of business
 - a) advance for supply of goods/services and such advance is appropriated against supply within 365 days from acceptance date (Except legal disputes)
 - b) Advance for an immovable property under agreement & such advance is adjusted against property as per terms of agreement
 - c) Security deposit for performance of Contract of supply of goods/Services
 - d) Advance received under long term projects for supply of Capital goods except courted (b) above
 - e) Advance received and as allowed by sectoral regulator or as per CG/SG direction
 - f) Advance for subscription towards publication (print/electronic mode)
 - g) Advance towards consideration for providing future services in form of warranty or maintenance contract as per written agreement provided such services does not exceed the period
 - i. Common business practice or
 - ii. Five years, whichever is less

Note 1 ⇒ Point (a) (b) & (d) becomes refundable due to reason that Co. do not have necessary approval, then deemed deposits

Note 2 ⇒ Amount deemed to be deposit on expiry of 15 days from the date they become due for refund

Prohibition on Acceptance of Deposits from Public [Section 73]

1. No Co. shall invite/accept/renew deposits from public except as in a manner provided under this chapter.
2. Above mentioned provision shall not apply to Banking co. or NBFC as per RBI Act or other Co. as may be prescribed (Housing Finance Co.)

Acceptance of Deposits from Members under section 73

1. Pass Ordinary Resolution in general meeting
2. Issuance of Circular
 - a) Circular in Form - DPT-1
 - b) Content of Circular
 - Financial Position
 - Credit Rating obtained
 - Total No. of depositors
 - Amount due towards previous deposits accepted by Co.
 - Other particulars as may be prescribed
 - c) File copy with ROC within 30 days before date of issue of circular
 - d) Signed by majority of directors of Co.
 - e) Issue to all members by RPAD or speed post or e-mode
 - f) May publish in newspapers (English + Vernacular)
 - g) Fresh Circular in each succeeding FY

3. **Attach Statutory Auditor Certificate stating :-**
 - a) Co. has not defaulted in repayment of deposit & interest or
 - b) Default, if any, has been made good and 5 Years have lapsed from the date such default was made good.
4. **Deposit Repayment Reserve A/C (DRR)**
 - a) Purpose of DRR ⇒ Repayment of deposit
 - b) keep in separate bank A/C of scheduled bank
 - c) Co. to deposit on or before 30th April of each year, minimum 20% of amount of deposit matured during following Year

Note:- DRR should not fall below 20% of amount of deposits maturing in current FY
5. **Certificate by Co.**
Co. has not defaulted in repayment of deposit & interest or
Default, if any, has been made good and 5 Years have lapsed from the date such default was made good.
6. **Providing security, if any, for repayment of amount of deposit or the interest thereon.**
 - Full unsecured deposit and partially secured deposits are termed as unsecured deposits in all the circular/forms/advertisement or document related to invitation of deposits
7. **If Co. fails to Repay deposit / interest then depositor may apply to Tribunal for an order directing Co. to pay sum due / any loss incurred by him any default or an order tribunal deem fit**
8. **3 types of Private Companies are exempt from following compliances while raising deposits from Members :-**
 - Issue of Circular
 - filing of Circular with ROC for registration
 - Depositing in DRR
 - Certificate

Type 1:-

Accepting money from members not exceeding 100% of PUSC + FR + SPA

Type 2:-

Start up - Pvt Co. for 5 years from date of Incorporation

Type 3:-

Private Co. who fulfills all the 3 conditions :-

- Not an associate or subsidiary Co. of any other Co.
- Borrowings from Banks / financial Institution or Body Corporate is less than twice of PUSC or Rs. 50 Crores, whichever is lower
- Co. has no subsisting default in repayment of borrowing at time of accepting deposits

However, all 3 types of private co. shall file the details of monies so accepted with RoC in form DPT-3

Other Provisions relating to Deposits

1. Tenure of deposit

Co. cannot accept deposits which is

- a) Repayable on demand
- b) Repayable within 6M or
- c) Repayable after 36 Months

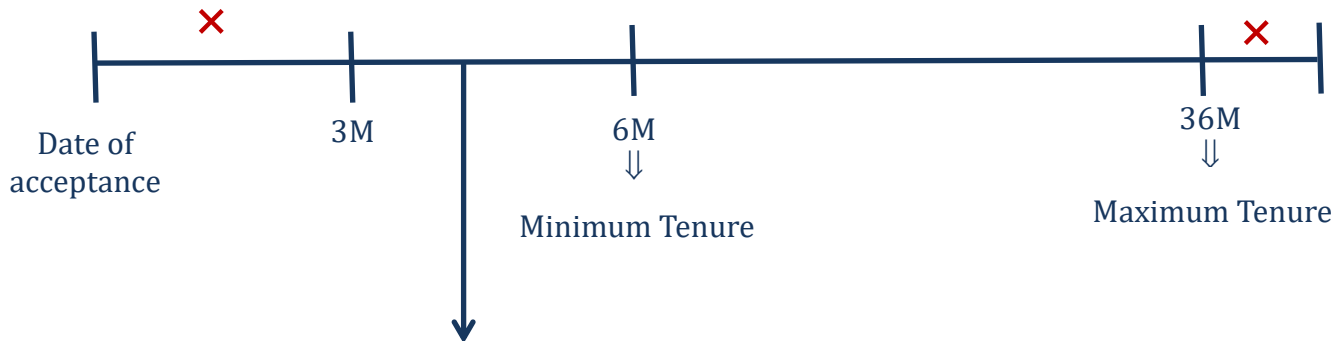

allowed if Deposit \leq 10% of PUSC + FR + SPA & for short term requirements

2. Maximum amount of deposits from Members (Existing + New Deposits)

1. Specified Private Companies \Rightarrow No limit on amount of deposits
2. Other Private Companies and IFSC Public Co. \Rightarrow 100% of (PUSC + FR + SPA)
3. Others Co. \Rightarrow 35% of (PUSC + FR + SPA)

Note:- Specified Private Companies:-

1. Startup Private Co. - for 10 years from date of its incorporation
2. Private Co. satisfying all 3 Conditions:-
 - Not an associate or subsidiary Co. of any other Co.
 - Borrowings from Banks / financial Institution or Body Corporate is less than twice of PUSC or Rs. 50 Crores, whichever is lower
 - Co. has no subsisting default in repayment of borrowing at time of accepting deposits

3. Maximum Rate of Interest on deposits

\Rightarrow Maximum as prescribed by RBI in case of NBFC for acceptance of deposits

4. Maximum Rate of brokerage payable on deposits

\Rightarrow Maximum rate prescribed by RBI in case of NBFC for acceptance of deposits

5. Deposit in Joint Names \Rightarrow Maximum 3

6. Depositor to file application form and declaration that money is not borrowed from any other person

7. Depositor may nominate a person at any time

8. Deposit Receipt :-

- Deposit receipt to be signed by officer authorized by board
- Deposit Receipt must state date and amount of deposit, name and address of depositor, rate of Interest & maturity date

- Co. is required to furnish deposit receipt to depositor or his agent within 21 days from date of receipt of money / realization of cheque / renewal
9. Register of deposits
- Every Co. accepting deposits shall maintain Register of deposits at Registered office.
 - Following particulars shall be entered separately in the case of each depositor:
 - (a) name, address and PAN of the depositor/s;
 - (b) particulars of the guardian, in case of a minor;
 - (c) particulars of the nominee;
 - (d) deposit receipt number;
 - (e) date and the amount of each deposit;
 - (f) duration of the deposit
 - (g) the date on which each deposit is repayable;
 - (h) rate of interest on such deposits to be payable to the depositor;
 - (i) due date for payment of interest;
10. Filing of duly audited Return (DPT-3) with ROC containing info up to 31st March of every year on or before 30th June.
11. Penal rate of Interest
If Co. fails to pay Secured/Unsecured deposits on maturity, then Co. shall pay 18% p.a. interest for overdue period.
12. No Right to Alter any Terms and Conditions of Deposit, deposit trust deed and deposit insurance contract which may prove disadvantageous to the interest of the depositors after circular or circular in the form of advertisement is issued and deposits are accepted.
13. In case of public Co., it shall disclose in its financial statements by way of note about the money received from its directors.
14. In case of a private Co., it shall disclose in its financial statements by way of note about the money received from the directors or the relatives of directors.
15. Punishment for Contravention: If any Co. inviting deposits or any other person contravenes any of the 'deposit rules' for which no punishment is provided in the Act, the Co. and every officer-in-default shall be punishable as under:
- With fine extendable to five thousand rupees; and
 - In case the contravention is a continuing one, with a further fine which may extended to five hundred rupees for every day after the first day during which the contravention continues.
16. Validity of Circular or advertisement - earlier of following dates :-

6 Months from Closure of FY in which Circular is issued

Date of AGM in which FS was laid before the Co.

Last day to conduct AGM as per relevant provisions, if No AGM is held

17. Premature repayment of deposits :- If depositor request for **premature repayment after 6 months but before actual date of maturity**, then the rate of interest will be calculated as follows:-

Step 1 ⇒ Round off the period in year.

- a) If less than 6 Months ⇒ Ignore
(Eg. - 2years, 3 Month) ⇒ 2 years
- b) If 6 Months or more ⇒ Round off to Next Year
(2years, 7 Months) ⇒ 3 years

Step 2 ⇒ Deduct 1% rate from the rate of Interest for period calculated in Step 1

However reduction is not applicable if

- i. deposit is prematurely repaid by Co. to bring the deposit amount within the prescribed limit
- or
- ii. deposit is prematurely repaid to provide for war risk or other benefits to personnel of naval, military, air forces or their families during emergency under Article 352 of Constitution of India

Acceptance of deposits from Public by certain Companies [Section 76]

1. Eligible Companies may accept deposit from public
2. Eligible Co. means public Co. having **net worth \geq ₹ 100 crores or turnover \geq ₹ 500 crores** And
Prior consent of members by **special resolution** in general meeting is required and **file Resolution with ROC** before making invitation to public
Note:- Ordinary Resolution if deposit is within limit of Section 180(1)(c)
3. **Credit Rating**
 - a) Obtain **Credit rating from recognised Credit Rating Agency** (as specified for NBFC)
 - b) **Inform** the credit rating to the public at the time of invitation of deposits.
 - c) Rating shall be **obtained atleast once in a year during tenure of deposits**
 - d) **Copy** of Credit Rating sent to **RoC** along with Return of deposits in form DPT -3
 - e) Credit rating shall **not below the minimum investment grade rating** or other specified credit rating for **fixed deposits**
4. **Creation of charge in case of Secured deposits**
 - a) Create **charge within 30 days of acceptance** of deposits
 - b) Charge in **favor of deposit holder or trustee** for depositor
 - c) Amount of **charge shall not be less than the amount of deposit accepted & interest thereon**
 - d) Co. **cannot create charge on Intangible Assets** (like Goodwill, Trademarks etc.)
 - e) **Market value** of security subject to charge shall be **assessed by registered valuer**.
 - f) Charge can be created on both **movable & immovable property**
5. **Appointment of Trustee for depositors**
 - a) One or more Trustees need to be **appointed by Co.** for creating security for deposits
 - b) **Written consent** shall be obtained from the trustees **before appointment**
 - c) **Statement** shall appear in **Circular** or advertisement that trustees have given their

consent for appointment

- d) Co. to **execute deposit trust deed (DPT-2) atleast 7 days before issuing circular**
- e) General Rule :- Trustee cannot be removed after issue of Circular & before expiry of his term
Exception :-
 - Can be removed with consent of ALL the directors present at Board Meeting
 - If Co. is required to have Independent Director(ID) ⇒ **At least 1 ID present in that Board Meeting**
- f) **Qualification of Trustee**
 Person (incl. a Co.) shall **not be appointed** as trustee if such person is
 - a. is a **director/KMP/ officer/employee** of CASH or depositor in the Co.
 - b. is **indebted to CASH** or subsidiary of such holding Co.
 - c. has any **material pecuniary relation**
 - d. has entered into any **guarantee arrangement** in respect of principal debts secured by deposit or interest thereon
 - e. is **related to any person** specified in clause (a) above
6. **Maximum amount of deposits by Eligible Co. (New + existing)**
 1. **Eligible Govt. Co. ⇒ 35% of PUSC + FR + SPA**
 2. **Eligible Companies other than Eligible Govt. Co.**
 - ⇒ From **Members ⇒ 10% of PUSC + FR + SPA**
 - ⇒ From **person other than its Members ⇒ 25% of PUSC + FR + SPA**
7. **Issuance of Circular in the form of advertisement**
 - a) **Publish in newspapers** – English + Vernacular
 - b) In Form DPT-1
 - c) **Placed on website** of Co., if any
 - d) Issued in the name of board of directors of Co.
 - e) Copy to ROC for Registration – at least 30 days prior to issue
 - f) **Signed by majority of directors**
 - g) Fresh Circulars for each Succeeding FY
 - h) Difference between Circular & Circular in form of Advertisement
 - Date of issue of Advertisement = Date on which Advertisement appeared in newspaper
 - Date of Issue of Circular = Date on which circular was dispatched
8. If depositor renew deposit before maturity date, for earning higher rate of interest, the **Co. shall pay him high rate of interest if deposit is renewed for period longer than unexpired period of deposit**
9. **Common Points for deposits from Members and deposits from public**
 - a) Tenure for deposits
 - b) Deposit Redemption Reserve Account
 - c) Maximum Rate of Interest
 - d) Maximum Rate of brokerage
 - e) Declaration by depositor
 - f) Deposit in Joint names
 - g) Nomination by depositor
 - h) Deposit Receipt
 - i) Register of Deposits

- j) filing Return of deposits with Registrar
- k) Penal rate of Interest (18% p.a.)
- l) Premature repayment of deposits
- m) Validity of circular/advertisement

Repayment of Deposits Accepted before Commencement [Section 74]

1. If deposits are accepted before commencement of the Act (before 01.04.2014) and remain unpaid as on (01.04.2014) then
 - a) File statement with ROC within 3 months from such commencement or from the due date of payment in form DPT-4
 - b) Repay within 3 years from commencement date or due date of payment whichever is earlier
2. On application by Co., Tribunal may extend the time limit to repay deposit after considering financial position of the Co., amt of deposits and interest thereon
3. Punishment for Non-Repayment of deposits:-
 - Co. ⇒ Minimum – Rs. 1 Crore – Maximum Rs. 10 Crore and
 - Officer in default ⇒
 - Imprisonment up to 7 years or
 - fine Minimum – Rs. 25 Lakh – Maximum – Rs. 2 Crores
 - or Both

Section 76A - Punishment for Contravention of Sec. 73 or Sec. 76

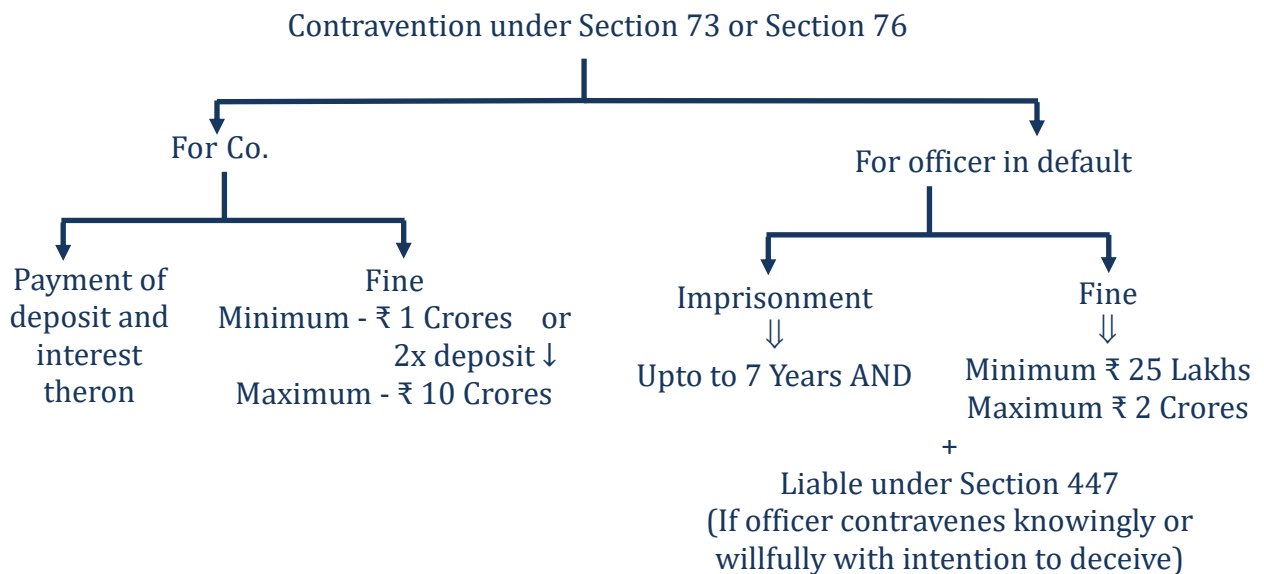

Net Worth [Section 2(57)]

| | Particular | ₹ |
|------|--|-----|
| | Paid up Share Capital | XXX |
| Add | All reserves created out of Profits | XXX |
| Add | Securities Premium Account | XXX |
| Add | Credit balance of P & L A/c | XXX |
| Less | Debit balance of P&L A/c | XXX |
| Less | Value of accumulated losses | XXX |
| Less | Deferred expenditure & misc. expenditure not written off | XXX |
| | Net worth | XXX |

Note :- Do not include Reserves created out of revaluation of assets, write back of depreciation and amalgamation

REGISTRATION OF CHARGES

Definition of Charge [Section 2(16)]

Charge means

- an **interest or lien**
- **created on the property** or assets of Co.
- or any of its undertaking
- or both
- **as security** (for repayment of loan)
- and **includes a mortgage**

Types of Charge

| Fixed Charge | Floating Charge |
|---|--|
| <ol style="list-style-type: none"> 1. Created on specific asset 2. Example:- Land/Building/Machinery etc. 3. Not allowed to sale without approval of chargeholder but Co. may use them 4. Charge is vacated when money repaid in full | <ol style="list-style-type: none"> 1. Created on Fluctuating assets 2. Example:- Raw Material, Stock-in-trade, debtors etc. 3. Permitted to use them for trading or producing final goods for sale 4. Floating charge become fixed on crystallization of floating charge |

Events in which floating charge crystalize

- When terms & condition of floating charge are violated
- Co. ceases to continue its business
- Co. goes into liquidation
- Creditor enforce the security covered by floating charge

Duty to Register Charges, ETC. [Section 77]

1. **Duty of Co. to register** the charge with RoC **within 30 days of creation** of charge.
2. Charges may be created within India/Outside India (i.e. Property may be situated in India/ outside India).
3. Property or Assets may be tangible/intangible
4. File **CHG-9 for debentures** or **CHG-1 for other than debentures with RoC**
5. **File instrument**, if any, signed by Co. & charge holder with RoC along with CHG-1/CHG-9
6. Time limit for registration of charges created on or after 2nd Nov 2018 :-

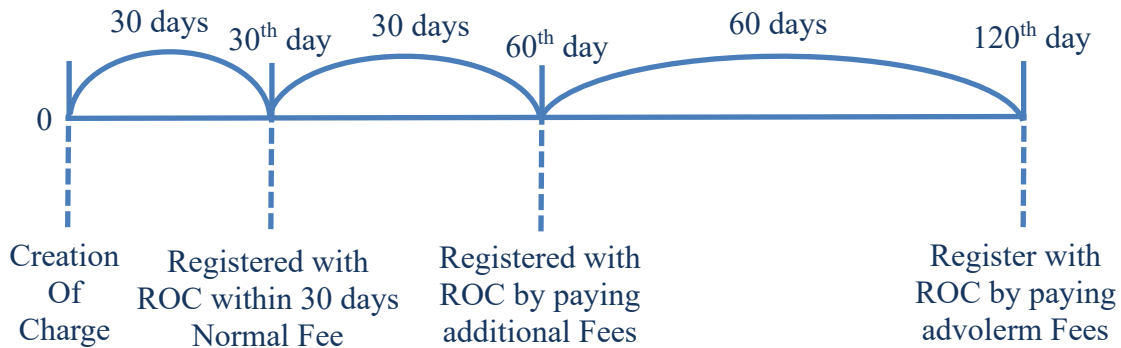

7. Verification of Instrument of Charges

| Property o/s India (wholly) | Property in India (partly or wholly) |
|--|--|
| a. Under the hand of <ul style="list-style-type: none"> ▪ Director or ▪ CS or ▪ Authorised officer of charge holder | a. Under the hand of <ul style="list-style-type: none"> ▪ Director or ▪ CS or ▪ Authorised officer of charge holder |
| Under the Seal, if any, of the Co. | ✗ |
| Under the hand of some person other than the Co. who is interested in mortgage or charge | ✗ |

8. Any charge created by banking Co. in favour of RBI need not be registered with RoC
9. Certificate of Registration / Modification
 - A. Where a charge or modification is duly registered, then ROC issues **Certificate of Registration (CHG-2) or Certificate of Modification (CHG-3)** as the case may be.
 - B. The Certificate issued by ROC is conclusive evidence that provision of this chapter are complied with.
10. Consequences of Non - Registration of Charge :-
 - a) Charge is **not taken into consideration** by
 - Liquidator
 - Any other Creditor
 - b) Charge holder loses priority

Note :- In case of non-registration of charge, **only security is lost but Co. is liable to repay the money.**

Application for Registration of Charge by Charge - Holder [Section 78]

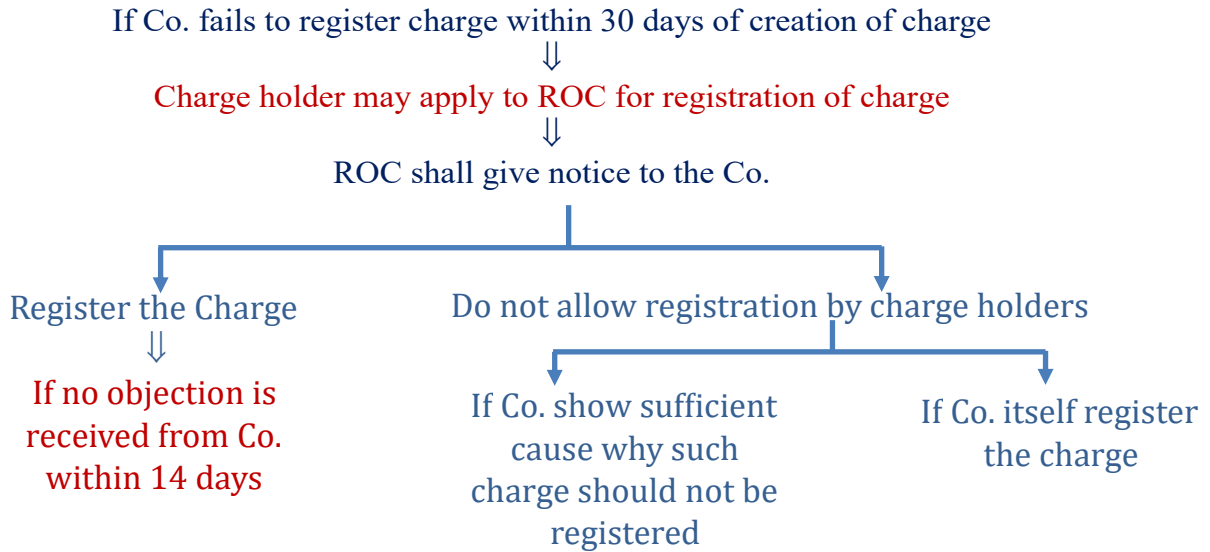

Note:- Chargeholder is entitled to recover from Co. the amt. of fees/additional fees paid by him to ROC.

Section 77 to apply in Certain Matters [Section 79]

The Provisions of section 77 relating to registration of charges shall apply to:-

1. Co. acquiring any property subject to charge
2. Modification in terms & conditions of already registered charge

Examples of Modification

- A. Varying terms & Condition of existing charge through agreement
- B. Enhancing or decreasing the limits
- C. Change in rate of interest (other than bank rates in case of fluctuating loans)
- D. Ceding a pari passu charge
- E. Change in repayment schedule of loan
- F. Partial release of charge on a particular Asset

Deemed Notice of Charge [Section 80]

Where any charge is registered under section 77, any person acquiring such property, assets, undertaking or part thereof or any share or interest therein shall be deemed to have notice of charge from the date of such registration

Section 81 :- Register of charges kept by ROC

1. In respect of every company, RoC shall keep a register containing particulars of the charges registered
2. Particulars of charges maintained on the Ministry of Corporate Affairs (MCA) portal shall be deemed to be register of charges for the purpose of section 81
3. Such registrar shall be open to inspection by any person on payment of fees

Company to Report Satisfaction of Charge [Section 82]

1. Co. shall give intimation to RoC in CHG-4 within 30 days of payment/ satisfaction in full
2. On application by Co. or chargeholder, RoC may allow within 300 days of payment/ satisfaction with additional fees
3. If intimation is not signed by charge holder, the RoC send notice to charge holder as why payment or satisfaction in full should not be recorded
4. Charge holder to reply within 14 days
5. If no cause is shown - Memorandum of satisfaction shall be enter in register of charge by RoC & issue certificate of satisfaction of charge to the Co. in CHG-5
6. If cause is shown -RoC record note to that effect in register of charges & inform the Co.
7. Instrument creating charge/modification to be preserved for 8 years from satisfaction of charge

Power of Registrar to Make Entries of Satisfaction and Release in Absence of Intimation from company [Section 83]

1. On receipt of satisfactory evidence related to registered charge that it has been paid or satisfied in whole or in part or
 - Part of property/ undertaking has been released or
 - part of property undertaking ceased to form part of property/undertaking then ROC may enter in register of charges
 - memorandum of satisfaction in whole or in part or
 - fact that part of property/undertaking has been released or ceased to form part of Co.'s notwithstanding that no information has been received by him from the company
2. ROC shall inform the affected parties within 30 days of making such entry in the register of charges

Intimation of Appointment of Receiver or Manager [Section 84]

| | |
|---|---|
| <p>If any person obtains an order for appointment of receiver or manager for the property subject to charge</p> <p style="text-align: center;">↓</p> <p>such person shall give notice in CHG-6 of appointment to RoC and Co. within 30 days from date of passing order along with copy of order</p> | <p>If any person appoints receiver or manager for the property subject to Charge under any power contained in any instrument</p> <p style="text-align: center;">↓</p> <p>such person shall give notice in CHG-6 to RoC & Co. within 30 days of making appointment along with copy of Instrument</p> |
| <p>On ceasing to hold such appointment such appointed person shall give notice to Co. & RoC and RoC shall register such notice</p> | |

Section 85 - Register of charges to be kept by Co.

1. Every Co. shall keep a register of charges
2. In form- CHG-7
3. Register to be maintained at its registered office
4. Register shall include
 - all charges and floating charges affecting
 - any property or assets of the Co.
 - or any of its under takings
 - indicating in each case the prescribed particulars
5. Copy of instrument creating the charge shall be kept at the registered office along with the register of charges
6. Entries in the register shall be made forthwith after the creation, modification or satisfaction of charge as the case maybe
7. Entries in the register shall be authenticated by
 - Director of the Co. or
 - Secretary of the Co. or
 - Any other person authorised by board for the purpose.
8. The register of charges & instrument of charges shall be open for inspection during business hours:-
 - a) by any member or creditor without payment of fees
 - b) by any other person on payment of prescribed fees
9. The register of charges shall be preserved PERMANENTLY
10. The instrument creating charge or modification thereon shall be preserved for period of 8 years from the date of satisfaction of charge.

Punishment for Contravention [Section 86]

If Co. is in default under this Chapter

Co. - ₹ 5 lakh and officer in default- ₹ 50000

If willfully furnishes any false or incorrect info then liable for action u/s 447

Rectification by CG in Register of Charges [Section 87]

1. Co. or any person interested in charge may apply to CG under this section
2. CG on being satisfied
 - a) **Omission to give intimation** to RoC of payment/ satisfaction of charge, within required time or
 - b) **Omission or misstatement of any particulars** in any filing previously made to ROC with respect to any charge/ modification
 - was accidental or
 - due to inadvertence or
 - some other sufficient cause or
 - not a nature to prejudice to creditor/shareholder,

Then CG may direct

- Time for giving intimation of payment / satisfaction of charge shall be extended or
- Rectification of omission or misstatement in register of charges

MANAGEMENT AND ADMINISTRATION

Section 88 : Register of Members, etc.

1. Every Co. shall keep and maintain following Registers :
 - (a) **Register of Members** (ROM) of each class of Equity shareholders and Preference shareholders held by members in or outside India [MGT 1]
 - (b) **Register of debenture holders** [MGT 2]
 - (c) Register of any **other securities holders** [MGT 2]
 2. Every register shall include an index of the names included therein
Note : Maintenance of **index is not necessary** in case the number of **member < 50**
 3. **Entries** in register shall be made **within 7 days**
 4. RoM shall be **maintained at RO**.
 5. However, **SR in GM** is passed to keep register at:
 - Any other place within city, town or village of RO or
 - Any place within India in which $> 1/10^{\text{th}}$ of total members reside
 6. Foreign Register (FR):
 - If authorized by AoA, Co. may **keep outside India**
 - A part of the register called **Foreign Register (FR)**
 - Containing names and other particulars of members /debenture holders/other share holders or Beneficial owner **residing outside India**.
 - Within 30 days from date of opening of FR, Co. shall file notice in form MGT-3 with RoC – Notice of situation of the office
 - In event of change in situation of office or discontinuance – **Intimate within 30 days in MGT-3**
 - FR = Deemed part of principal register
 - Entry in FR is done after Board of Directors approves allotment
 - Co. shall:
 - (a) Transmit to RO in India a copy of every entry in any FR within 15 days of making entry
 - (b) Keep at such office a duplicate register of every FR duly entered up from time to time
 - On discontinuance of FR, all entries in that register shall be transferred to:
 - Some other FR kept by the Co. outside India or
 - To the principal register
- Failure to maintain register u/s 88, Co. –Rs. 3 Lakhs OID – Rs. 50,000

Note :

1. A minor's name cannot be entered in RoM. Only legal guardian's name can be entered
2. Joint SHs may request the Co. to enter their names in RoM in a certain order, or part of the holding is entered showing the name of one holder and part showing the name of another. However, it is not possible that name of only one of the joint SH is written in RoM.

Section 89 : Declaration in respect of Beneficial Interest in any share

1. Declaration

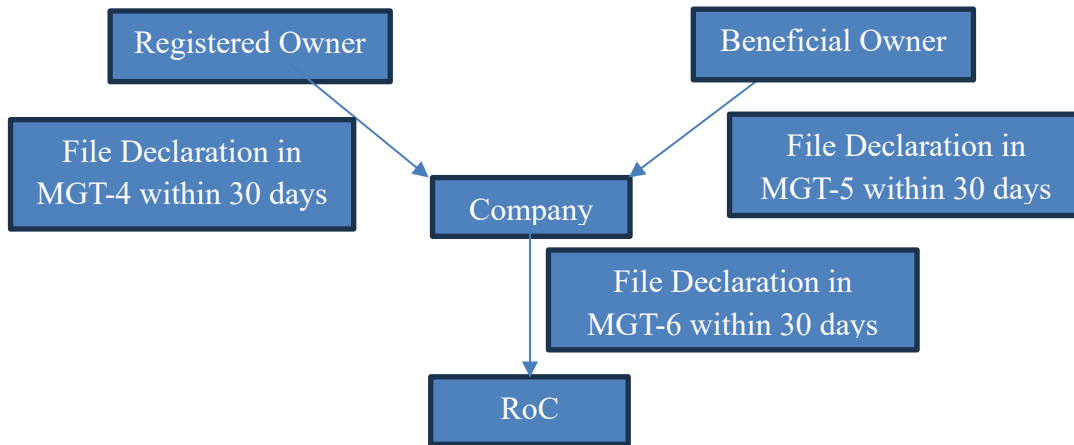

2. Where **any change occurs in BI** such shares, such person and BO shall – **within 30 days** from date of such change, **make a declaration to the Co.** in prescribed form.
- 3.
4. Where **declaration** required under this section is **not made by BO-No rights** in respect of such shares shall be **enforceable by him**
5. Notwithstanding this section, **Co. to pay dividend to members**
6. Trust created to set up Mutual fund, venture capital fund or other SEBI approved fund – Need not file such declarations.
7. Penalty :
 Failure to make declaration to Co. – Rs. 50000 + 200/day – Max 5 lakhs
 Failure of Co. to file MGT 6 – Co. + officers in default – Rs. 1000/day –Max 5 lakhs (Co.) and 2 lakhs (OID)
8. Every company shall designate a person who shall be responsible for furnishing, and extending co-operation for providing, information to the Registrar or any other authorised officer with respect to beneficial interest in shares of the company.
9. The company may designate-
 - (i) a company secretary, if there is a requirement of appointment of such company secretary under the Act and the rules made thereunder; or
 - (ii) a key managerial personnel, other than the company secretary; or

(iii) every director, if there is no company secretary or key managerial personnel.

10. Until a person is designated as referred under sub-rule (4), the following persons shall be

deemed to have been designated person;

(i) company secretary, if there is a requirement of appointment of such company secretary under the Act and the rules made thereunder; or

(ii) every Managing Director or Manager, in case a company secretary has not been appointed; or

(iii) every director, if there is no company secretary or a Managing Director or Manager.

Every company shall inform the details of the designated person in Annual return.

11. If the company changes the designated person at any time, it shall intimate the same to the Registrar in e-form GNL-2

Section 90 : Register of significant beneficial owners in a Co.

Significant Beneficial Owner means an individual holding indirectly or together with any direct holdings not less than 10 percent of beneficial interest

↳ Every SBO shall make a declaration to the Co. the nature of his interest and other particulars in form BEN -1 within 30 days of becoming SBO

↳ Every Co. shall maintain a register of SBO and changes therein in Form BEN-3 which shall include the name of individual, his date of birth, address, details of ownership and other prescribed details.

↳ The register shall be open to inspection during business hours, at such reasonable time of not less than 2 hours on every working day, by any member on payment of fee specified by Co. – not more than Rs. 50 for each inspection.

↳ Return of SBO :

Every Co. shall file return of SBO of the Co. and changes therein in Form BEN-2 with the RoC containing names, addresses and other prescribed details within 30 days of receipt of declaration from SBO in form BEN-1

Every Co. shall take necessary steps to identify an individual who is a SBO in relation to the Co. and require him to comply with the provisions of this section

↳ A Co. shall give notice in form BEN-4 to any person, whether or not a member) whom the Co. knows or has reasonable grounds to believe

(a) to be a SBO of the Co.

(b) to be having knowledge of identify of a SBO or another person likely to have such knowledge

(c) to have been a SBO of the Co. at any time during 3 years immediately preceding the date on which the notice is issued and who is not registered as a SBO with the Co. as required under this section

↳ Information required by notice, concerned person to give within 30 days of date of the

notice.

- ↳ Apply to tribunal:
 - ❑ where that person fails to give information with time specified therein or
 - ❑ where information given is not satisfactory
- The Co. shall apply to tribunal within 15 days of expiry of period specified in notice, for an order directing that shares in question be subject to restrictions w.r.t. transfer of interest
- ↳ After giving OOBH to parties concerned, Tribunal may make such order restricting the rights attached with the shares within 60 days of receipt of application.
- ↳ Co. or the person aggrieved by order of Tribunal may apply to Tribunal for relaxation of lifting of the restrictions placed, within 1 year from the date of such order.
- ↳ Provided that if no application is made within 1 year, such shares shall be transferred to IEPF Authority

Penalty us/s 90

- ❑ If a person fails to make declaration under sub sec 1, such person will be held liable and shall pay a penalty of Rs. 50000/-.
For continuing failure penalty shall be Rs. 1000/day, max Rs. 2 Lakhs.
- ❑ If Co. fails to maintain register or allow inspection there of :
 - Co. shall be liable to pay penalty of Rs. 1 Lakh
For continuing failure penalty shall be Rs. 500/ day, max Rs. 5 lakhs
 - Officer in default shall be liable to pay penalty of Rs. 25000/-
For continuing failure penalty shall be Rs. 200/day, max Rs. 1 lakh
- ❑ If person willfully furnishes false or incorrect information or suppresses material information, then such person shall be liable for action u/s 447

Section 91 : Power to close Register of Members or Debenture Holders or Other Security Holders

- ↳ A Co. may close the RoM or register of Debenture Holders or Other security Holders for any period, subject to:
 - ❑ such period shall not exceed in aggregate 45 days in each year and not exceed 30 days at any one time
 - ❑ previous notice has to be given in prescribed manner of at least 7 days or such lesser period as specified by SEBI for listed companies which intend to get their securities listed.
- ↳ In case of contravention, Co. and officer in default – Rs. 5000 for every day during which register was closed subject to max Rs. 1 lakh

Section 92 : Annual Return

Every Co. shall prepare a return containing the following details as on close of FY:

- RO, Principal business activities
- Particulars of holding, associate or subsidiary (Group companies)
- Shares, debentures or other securities and shareholding pattern
- Members, Debenture Holders, Other security Holders and change since previous FY
- Promoters/Directors/Key Managerial Persons and changes since previous FY
- General meetings, BoD meetings, committee meetings and attendance details
- Remuneration of directors/key Managerial Person
- Penalty on Co., directors or officers + compounding + Appeals
- Certificate of compliance
- Details of shares held by Foreign Institutional Investors
- Other matters

Annual Returns:

- ↳ Sign on annual return
 - OPC, Small Co., pvt start up Co.– Annual Return to be signed by CS. Where there is no CS, by director
 - Other companies – By a director + CS. Where there is no CS, by CS in practice
- ↳ Form for annual return
 - OPC and Small Co. – **MGT – 7A**
 - Other companies – **MGT – 7**
- ↳ Annual return to be **certified by CS in Practice**
 - Listed Co.**
 - Companies having **PUSC not less than 10 crores** or **T/O not less than 50 crores** Shall be certified by CS in practice **in form MGT-8** stating that:
 - annual return discloses the facts correctly and adequately and
 - Co. has complied with all the provisions of this Act
- ↳ Place on website

Annual return on website of Co. and web-link thereof – Disclose in Board of Director's Report
- ↳ File with RoC

Every Co. shall **file with RoC a copy of Annual Report + Fees:**

 - within 60 days from date on which AGM is held** or
 - where no AGM is held in any year, **within 60 days from date on which AGM should have been held** + specifying reason for not holding AGM

↳ Penalty

Where Co. fails to file annual return within prescribed time, penalty payable:

Co. – Rs. 10000 + Rs. 100/day upto max Rs. 2 lakhs

Officer in Default – Rs. 10000 + Rs. 100/day upto max Rs. 50000

↳ Penalty on CS in practice

If CS in practice certifies the Annual Return otherwise than in conformity with the requirement of this section, he shall be liable to a penalty of Rs. 2 lakhs.

Section 94 : Place of keeping and Inspection of Registers, Returns, etc to be preserved

- (1) Register u/s 88 and copy of annual return filed u/s 92 shall be **kept at the RO**
- (2) It may also be kept at **any other place in India** in which $> 1/10^{\text{th}}$ of the total number of **members**, as per RoM, **reside, if approved by SR**

| | | |
|--|--------------------------------------|---|
| Register of Members | Permanently | Kept in custody of CS or any other person authorised by board |
| Register of debenture or other security holder | 8 Years from date of redemption | |
| Foreign Register of Members | Permanently | |
| Foreign Register of debenture or other security holder | 8 years from date of redemption | |
| Annual Return | 8 Years from date of filing with RoC | |

- (3) Inspection of Registers, Indices and Annual Returns shall be open for inspection during business hours (for minimum 2 hours)
 - by **members, debenture holders or other security holders – without any fees**
 - by any **other person – on payment of such fees** as prescribed
- (4) Any member/debenture holder/other security holder/beneficial owner/any other person may-
 - take extracts from any register or index or return without payment of any fee or
 - require a copy there of on payment of fees as per AoA (not > Rs. 10 /page) **Co. to provide copies within 7 days**
- (5) On refusal of any inspection or making extract or copy:
 - Co. and every officer in default – liable for each such default, to a penalty of Rs. 1000/day subject to a max of Rs. 1 lakh during which the refusal or default continues.
 - CG may also, by order, direct:

- an immediate inspection of the document or
- that extract required shall for the with the allowed to be taken by person requiring it.

Section 95 : Registers, etc. to be evidence

The registers, their indices and copies of annual returns maintained u/s 88 and 94 shall be prima facie evidence.

Section 96 : Annual General Meeting

Due Date of AGM:

| First AGM | Subsequent AGM |
|---|--|
| Within 9 month from the end of FY | Within 6 months of closure of FY |
| No AGM is necessary in year of incorporation | Not more than 15 months shall elapse between 2 AGMs |
| | AGM to be held in each calendar year |
| RoC has no power to grant extension for First AGM | For special reason, RoC may grant extension for period upto 3 months |

AGM shall be called during business hours [9 AM to 6 PM] on any day other than national holiday as declared by CG.

Place of holding AGM:

| Type of Co. | Place of Holding AGM |
|---------------------|---|
| AGM of Govt Co. | RO or within city/town/village where RO is situated or other place approved by CG |
| AGM of unlisted Co. | Held at any place in India if consent in writing/e-mode by ALL members in advance |
| AGM of other Co. | Held at RO or some other place within city, town/village where RO is situated |

Section 97 : Power of Tribunal to call AGM

- (a) In case of default in holding AGM u/s 96, , on application by any members of Co., Tribunal may call or direct calling of AGM and give such consequential directions.
- (b) Directions may include that 1 member present in person or proxy shall be deemed to constitute a meeting

Section 98 : Power of Tribunal to call EGM of members

- (a) Either suo moto or on application of director or member entitled to vote at the meeting,, Tribunal may order a meeting of Co. to be called, held and conducted in manner as Tribunal thinks fit and give such ancillary directions as may be expedient
- (b) Directions may include that 1 member present in person or proxy shall be deemed to constitute a meeting

Section 99 : Punishment for default u/s 96 to 98

If default is made in holding meeting u/s 96 to 98 or in complying Tribunal's directions: Co. and officer in Default – Fine which may extend to Rs 1 lakh + continuing default – further Rs. 5000/day

Section 100 : Calling of Extraordinary General Meeting (EGM)

- ↳ Board may, whenever it deems fit, call an EGM of the Co.
It shall be held at a place in India except in case of wholly owned subsidiary of Co. incorporated outside India
- ↳ Board shall, at the requisition made by following Call an EGM of the Co.
 - ❑ Co. having share capital – Members holding not less than 1/10th of total Paid up share capital
 - ❑ Co. not having share capital – Members having not less than 1/10th of total voting power
- ↳ The requisition shall:
 - ❑ set out matters for consideration at the meeting
 - ❑ signed by requisitionists
 - ❑ sent to RO of the Co.
- ↳ The Board shall
 - ❑ call for such meeting within 21 days from receipt of valid requisition
 - ❑ meeting to be called on a day not later than 45 days from date of receipt of valid requisition.
- ↳ On failure of board to call such meeting – Requisitionists may themselves call and hold such meeting within 3 months of date of requisition
- ↳ Meeting by requisitionists to be called, held and conducted in same manner as it is called and held by Board of Directors.
- ↳ Reasonable expenses of such meeting shall be reimbursed to requisitionists by Co. and such sum shall be deducted from remuneration u/s 197 of directors who were in default in calling the meeting.

Rule 17 : Calling of EGM by requisitionists:

- ↳ Such requisition has to be in writing or e-made at least 21 clear days prior to proposed date of EGM
- ↳ Notice to specify place, date, day and hour of meeting and contain business to be transacted thereon. The meeting shall be convened at RO or in the same city or town where Reg. office is situated on any day except national holiday
- ↳ If proposed resolution is a special Resolution – Give notice as required u/s 114 (2)
- ↳ The notice shall be signed by all requisitionists or by a requisitionists duly authorized in writing
- ↳ No explanatory statement needs to be annexed to notice for such EGM. They may disclose reasons for proposed resolutions at the meeting.
- ↳ Notice shall be given to those members whose names appear in Reg. of Members within 3 days of receipt of a valid requisition by the Co..
- ↳ Where meeting is not convened, the requisitionists shall have a right to receive:
 - list of members
 - their registered address and
 - number of shares held and
 the Co. is bound to give such information as on 21st day from date of receipt of valid requisition form together with such changes, if any, before expiry of 45 days from such receipt.
- ↳ Mode of sending notice – speed post or registered post or through e-mode
- ↳ Accidental omission to give notice, or the non-receipt of such notice by, any member shall not invalidate the proceedings of the meeting

Section 101 : Notice of Meeting

- ↳ General meeting may be called by giving **not less than CLEAR 21 days notice** in writing
- ↳ Note - Calculation of clear 21 days excludes date on which notice is served AND date of meeting.
or
- ↳ General Meeting may be called after giving **shorter notice if consent is given:**
 - In case of AGM – by not less than 95% of members entitled to vote thereat
 - In case of any other GM:
 - In case of Co. having Share Capital – Majority in numbers + representing not less than 95% of Paid up share capital
 - In case of Co. not having share capital – Members having not less than 95% of total voting power
- ↳ Notice to specify place, date day and hour of meeting and contain business to be transacted thereon
- ↳ Notice to be given to every member of the Co. / legal representative of deceased member or assignee of insolvent member, auditors of the Co. and every director of the Co..
- ↳ Accidental omission to give notice to, or the non-receipt by any member shall not

invalidate the proceedings of the meeting

Rule 18 : Modes of sending notice

- Sending of notices through electronic mode has been statutorily recognized
- Electronic mode means :
 - any communication sent by Co. through authorized and secured computer program
 - capable of producing confirmation and
 - keeping record of such communication addressed to the person entitled to receive
 - at the last e-mail address provided by the member
- ↳ Notice may be sent through e-mail as a text, attachment or URL
- ↳ Email to be addressed to entitled person – as per records of depository.
- ↳ Co. to allow changing or adding email IDs at least once in a FY.
- ↳ Subject line of email – state the name of Co., notice of type of meeting, place and date.
- ↳ Place notice on website of the Co. and other website notified by Central Govt.
- ↳ Where notice is sent by post, it shall be deemed to be served at expiration of 48 hours after the letter containing the same is posted.

Section 102 : Statement to be annexed to notice – Explanatory statement

1. A statement setting out following Material facts concerning each item of special business shall be annexed to notice calling such meeting
 - the nature of interest (finance/otherwise) in respect of each items of every director and manager, every other KMP and their relatives.
 - other info and facts that may enable to understand meaning, scope and implication of items of business and take decisions.

Where, as a result of non-disclosure or insufficient disclosure of interest (as required above), if any benefit accrues to promoter, director, manager, KMP or their relatives. They shall hold such benefit in the trust of the Co. and liable to compensate the Co. to extent of such benefit.

2. Special business in AGM

In case of AGM, all business shall be deemed special other than

- Consideration of financial statements and reports of Board of Directors and auditors
- Declaration of dividend
- Appointing of director in place of those retiring
- Appointment of and fixing remuneration of auditors

All business in EGM are deemed to be special business

Provided that:

- Where any item of special business relates to or affects any other Co.
- The extent of shareholding interest in that other Co. of:

- ❑ every promoter, director, manager, if any and
 - ❑ of every other KMP of the first mentioned Co.
 - shall be set out in the Explanatory statement, if not less than 2% of paid up share capital of that Co. [A Ltd]
- If any default is made in complying with this section then every promoter, director, manager, KMP who is in default – Liable for penalty: Higher of – Rs. 50000 or
- 5 times the amount of benefits accrued to such promoter, director, manager, KMP of their relative

3. Explanatory statement not required for transacting ordinary business

Section 103 : Quorum for meetings

1. Unless articles provide for a larger number:

(a) In case of a public Co.:

| No. of members as on date of meeting | Members personally present |
|--------------------------------------|----------------------------|
| Not more than 1000 | 5 |
| More than 1000 but upto 5000 | 15 |
| More than 5000 | 30 |

(b) In case of a private Co. – **2 members personally present**

2. **Proxy is not counted** for purpose of quorum but Authorised representative is counted
3. Quorum shall be **present throughout the meeting**
4. If quorum is **not present within half an hour** from appointed time:
 - (a) Meeting called by requisitionist u/s 100 – stands cancelled
 - (b) Any other meetings – Adjourned to same day, next week at same time and place or such other date as board may determine.

In case of adjourned meeting or change of day, time or place of meeting – the Co. shall give not less than 3 days notice to members either individually or publish ad in newspaper – English + Vernacular)
5. If at adjourned meeting, quorum is not present within half an hour – Members (>1) present shall be Quorum

Section 104 : Chairman of meetings

1. Unless AoA provides otherwise, members personally present shall **elect one of themselves to be chairman on show of hands**
2. If poll is demanded on election of chairman:
 - **Poll shall be taken forthwith** and Chairman elected under by show of hands shall continue to be chairman until some other person is elected chairman by way of poll
 - Such **other person appointed by poll to be chairman for rest of the meeting**
3. Other points:
 - **Chairman** is a person who **manages meetings and ensured decorum** is maintained
 - Chairman has **prima facie authority to decide all questions arising in the meeting**
 - If authorised by AOA Chairman has **casting vote in Board Meeting and General Meeting**

Section 105 : Proxies

1. Any **member may appoint proxy** to attend meeting and vote on his behalf
2. Proxy need not be member of Co. (except in case of section 8 Co.)
3. Proxy shall have **no right to speak at meeting**
4. Proxy **cannot vote on show of hands**
5. Limit – A proxy can represent **maximum 50 members** in a meeting having not more than **10 % of total share capital.**
6. However, Proxy can be appointed for a single member holding more than 10 percent of share capital but the such person cannot be appointed as proxy of any other member
7. **Appointment of proxy shall be in form MGT-11**
8. Proxy form **must be deposited 48 hours before the meeting.** This Limit cannot be increased by company through AOA
9. If invitations to appoint as proxy a person are issued at the Co.'s expense to any member
 - Every officer who issues or authorized such issue – Liable for penalty of Rs. 50000
 - Provided that officer not liable if such issue is at the member's request in writing.
10. An instrument appointing **proxy in form MGT – 11** shall not be questioned on the grounds that it falls to comply with special requirements by the AoA
11. Inspecting proxy forms by members:

Every member entitled to vote at the meeting – entitled to inspect proxies lodged.

Provided that:

 - Inspect during period – 24 hours before time fixed for commencement of meeting and ending with conclusion of meeting during business hours
 - Not less than 3 days notice in writing of intention given to Co..

Section 106 : Restriction on voting rights

- ↳ If AOA provides then member shall not exercise voting right in respect of shares on which:
 - call or other sum is unpaid
 - Co. has exercised any right of lien
- ↳ Except as specified above, a Co. shall NOT prohibit member from voting right on any other ground
- ↳ In case of poll, member need not use all his votes in same way

Section 107 : Voting by show of hands

1. Resolution in General Meeting is decided on show of hands unless Poll is demanded or e-voting
2. Following Shall be conclusive evidence of fact of passing of resolution or otherwise:
 - (a) declaration by chairman of passing of such resolution and
 - (b) entry to that effect in the minutes of the meeting

Section 108 : Voting through electronic means

- (1) Mandatory E-voting facility by :
 - (a) every Co. having listed its equity shares in a RSE
 - (b) every Co. having ≥ 1000 members
 Exempt for Nidhi Co.
- (2) Procedure for E-voting facility :

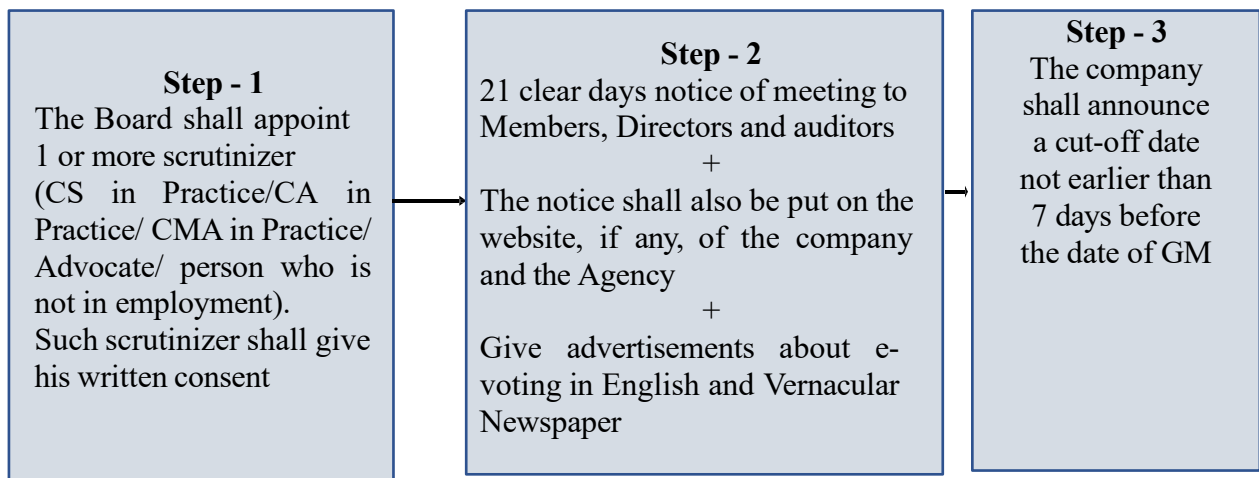

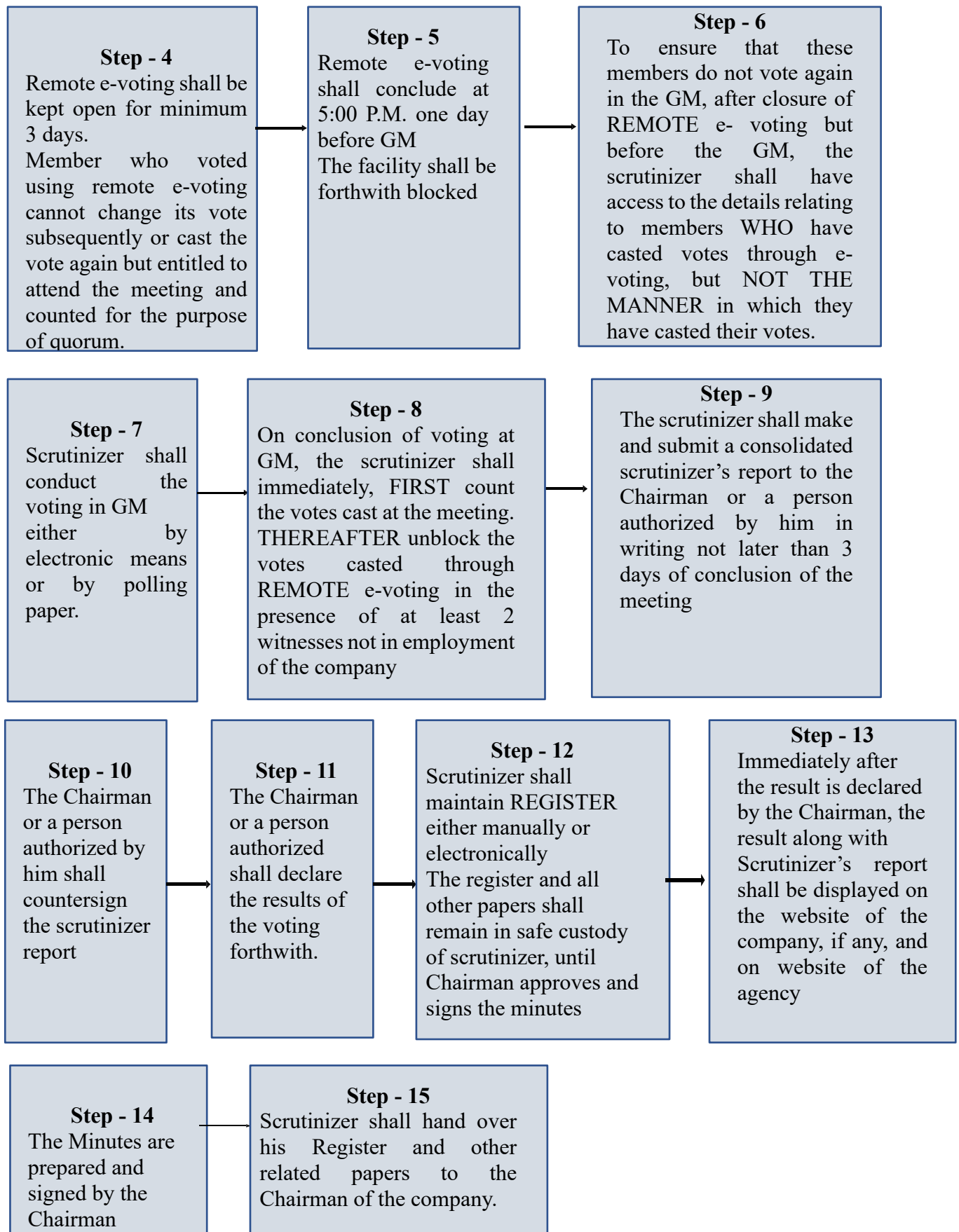

Section 109 : Demand for Poll

- ↳ **Before or on declaration of result** of voting on any resolution **on show of hands**:
 - A **poll may be ordered** to be taken by the chairman **on his own motion** and
 - Shall be ordered to be taken by **him on a demand made in that behalf**:
 - Co. having share capital – by members present in person or proxy having $\geq 1/10^{\text{th}}$ of total voting power or holding shares in aggregate having paid up share capital $> =$ Rs. 5 lakhs or higher amount prescribed
 - Other companies – by members present in person or proxy having $\geq 1/10^{\text{th}}$ of total voting power
- ↳ The demand for a poll **may be withdrawn at any time by the person who made the demand**
- ↳ A **poll demanded for adjournment** of meeting or **appointment of chairman** of meeting to be **taken forthwith**
- ↳ A poll demanded on any question other than adjournment/appointment of chairman shall be taken **within 48 hours from time it was demanded**
- ↳ Where poll is to be taken, the **chairman shall appoint** such number of persons, as he deems necessary, **to scrutinize the poll process** and votes given on poll and to report to him in manner prescribed
- ↳ Chairman of the meeting shall have power to regulate the manner in which the poll shall be taken
- ↳ Result of poll shall be deemed to be the decision of the meeting on the resolution on which the poll was taken

Rule 21 : Manner in which chairman shall get the poll process scrutinized:

Chairman of the meeting shall ensure the following:

- (a) Scrutinizers are provided with:
 - Register of Members, specimen signs of members, attendance and proxy register
 - All documents pursuant to sec 105, 112 and 113
- (b) Scrutinizers to arrange polling papers (Form MGT-12) and distribute it to members and proxies present

In case of joint share holders – Give polling paper to first named holder (in his absence – joint holder)
- (c) Scrutinizers to keep record of the polling papers received in response to poll, by initialling it
- (d) Scrutinizers shall lock and seal an empty polling box in presence of members and proxies
- (e) In case of ambiguity about validity of a proxy, scrutinizers + Chairman to decide validity
- (f) Ensure that if member who has appointed proxy, has voted in person, proxy's vote disregarded

- (g) Scrutinizers shall count votes cast on poll and prepare a report addressed to the chairman. The report shall be in form MGT-13 such report shall be signed and submitted within 7 days from date of poll. Chairman to counter sign the same
- (h) Where voting is conducted by e-means u/s 108 and rules made thereunder, Co. shall provide all the necessary support, technical and otherwise, to scrutinizers in orderly conduct of voting and counting the result thereof
- (i) Scrutinizers report shall state total votes casted, valid votes, votes in favour and against the resolution including the details of valid polling papers and votes comprised therein
- (j) Chairman shall declare the result of voting on poll. The result may either be announced by him or a person authorised by him in writing.

Section 110 : Postal Ballot

1. Postal ballot can be **conducted by post or through e-mode**
2. Following items of business shall be transacted only by means of voting through a postal ballot
 - Sec 13 – Alteration of object clause of MoA
 - Sec 18 – Alteration of AoA to insert or remove provisions which u/s 2 (68) are required to be included in AoA of private Co.
 - Sec 12 – Change in place of Reg. office outside local limits of city/town/village
 - Sec 13 – Change in object for which money raised from public
 - Sec 43 – Issue of shares with differential rights
 - Sec 48 – Variation in rights attached to class of shares
 - Sec 68 – Buy – back of securities
 - Sec 151 – Election of a director
 - Sec 180 – Sale of undertaking of Co.
 - Sec 186 – giving loans, guarantees in excess of limit
 - ↳ OPC and companies having members upto 200 are not required to transact any business through postal ballot
3. If a resolution is assented to by the requisite majority of share holders by means of postal ballot, it shall be deemed to have been duly passed at a General Meeting convened in that behalf

4. Procedure of Postal Ballot:-

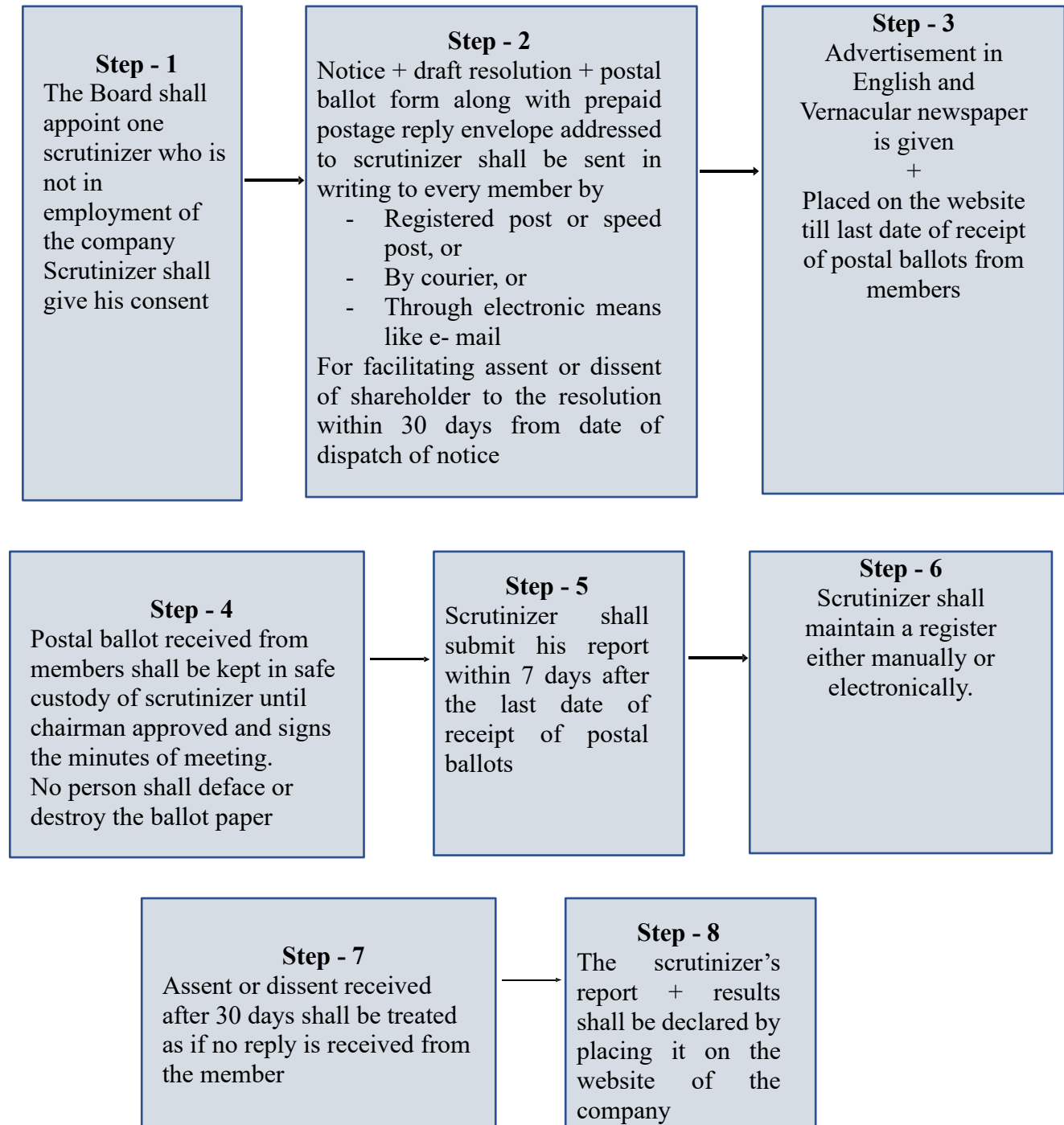

Section 112 : Representation of President and Governors in meetings

- ↳ The President of India or Governor of state, if he is a member of a Co., may appoint such person as he thinks fit to act as his representative at any meeting of the Co.
- ↳ Such appointed shall be deemed to be a member and shall be entitled to appoint proxy as well.

Section 113 : Representation of Corporations at meeting of companies and of creditors

- ↳ A body corporate may:
 - If it is a member of a Co. – by Board resolution, authorise such person as it thinks fit to act as its representative at any meeting of the Co.
 - if it is a creditor including debenture holder – by Board resolution, authorise such person as it thinks fit to act as its representative at any meeting of any creditors
- ↳ Such appointed shall be deemed to be a member and shall be entitled to appoint proxy as well.

Section 114 : Ordinary and Special Resolutions

- ↳ A resolution shall be an **Ordinary Resolution** ($V_f > V_a$) if:
 - Notice has been duly given and
 - votes cast in favour, including casting vote, if any, of chairman, by members
 - Exceed the votes, if any, cast against the resolution by members
- ↳ A resolution shall be a **Special Resolution** ($V_f \geq 3V_a$) if-
 - (a) the intention to propose the resolution as a special Resolution has been duly specified in the notice calling the General Meeting or other intimation given to the members of the resolution
 - (b) The notice required under this Act has been duly given and
 - (c) The votes cash in favour by entitled members is not less than 3 times no. of votes, if any, cast against such resolution.

Section 115 : Resolutions requiring Special Notice

- ↳ Special Notice shall be signed, individually/collectively, and given by such no. of members holding:
 - not $< 1\%$ of total voting power or
 - holding shares on which not $< \text{Rs } 5$ lakhs has been paid up on the date of the notice

- ↳ Notice of meeting to be sent to Co. not earlier than 3 months but at least 14 days before date of meeting, exclusive of day on which the notice is given and day of meeting
- ↳ Immediately on receipt of notice Co. to give notice to its members of the resolution – at least 7 days before meeting, exclusive of date of dispatch and day of meeting
- ↳ Where it is not practicable to give notice– Publish notice in newspaper (English/vernacular) and post it on the website of Co.
- ↳ The notice shall be published at least 7 days before the meeting, exclusive of the day of publication of the notice and day of the meeting
- ↳ Special notice is required in following cases :
 - Sec 140 – Appointment of auditor other than retiring auditor
 - Sec 169 – Removal of director
 - Or Matters provided in AOA

Section 116 : Resolutions passed at adjourned meeting

Where a resolution is passed at an adjourned meeting of Co., deemed to be passed on the date on which it was actually passed.

Ex : EGM dated 22nd Sept. Quorum absent. Adjourned – 30th Sep. Two resolutions passed in adjourned meeting. Effective date of resolution = 30th Sep and not 22nd Sept.

Section 117 : Resolutions and agreements to be filed

- ↳ A copy of below mentioned documents with explanatory statement u/s 102 if any, File with RoC in Form MGT 14 within 30 days of passing such resolution or making such agreement
 - Special Resolution
 - Resolution agreed to by all the members
 - Agreement executed by Co. related to appointment, re-appointment or variation of terms of Managing Director
 - Any resolutions of Board of Directors
 - Resolutions or agreements which have been agreed to by any class of members
 - Resolution to be wound up voluntarily u/s 59 of Insolvency and Bankruptcy Code
 - Resolutions passed u/s 179 (3)
 - Any other resolution or agreement
- ↳ In case of failure to make such filing with RoC, penalty shall be as follows:
 - Co. – Rs 10000 + Rs 100/day after first, Max. of Rs. 2 Lakhs
 - Officer in Default – Rs. 10000 + Rs 100 / day after first, Max of Rs. 50000

Section 118 : Minutes of proceedings of General Meeting and resolutions passed by Postal ballot :

- ↳ The Co. shall cause the minutes to be prepared, signed and kept in the minute books within 30 days of the conclusion there of:
 - General meetings of any class of share holders or creditors
 - Board meetings or meetings of any committee thereof
 - Resolutions passed by postal ballot
- ↳ Minutes shall contain fair and correct summary of the proceedings
- ↳ Appointments made at any meetings shall be included in minutes
- ↳ In case of meeting of Board of Directors or committee there of, the minutes shall also include names of directors present where a resolution is passed the names of dissenting directors
- ↳ Below mentioned matters shall not be included in the minutes which, in opinion of chairman:
 - reasonably be regarded as defamatory of any person
 - irrelevant or immaterial to proceedings
 - detrimental to interest of Co.
- ↳ Chairman shall exercise absolute discretion w.r.t. inclusion or exclusion of any matter
- ↳ Minutes = Evidence of the proceedings recording therein
- ↳ If any default is committed under this section, then penalty payable shall be:
 - By Co. – Rs. 25000
 - By officer in Default – Rs. 5000
- ↳ Person found guilty of tampering with minutes – Jail upto 2 years and fine of Rs. 25000 to Rs 1 lakh
- ↳ Every Co. to observe secretarial standard specified by ICSI

| Particulars | Of General Meeting | Of BoD or Committee |
|-------------|--|--|
| Keep at | RO | RO or such place as BOD may decide |
| Preserve | Permanently | Permanently |
| Custody | CS or director duly authorised by BOD | CS or director duly authorised by BOD |
| Signed by | By chairman of the same meeting within 30 days In event of death or inability of chairman – a director duly authorised by the BOD | by chairman of said meeting or chairman of next succeeding meeting |

Section 119 : Inspection of minute – book of General Meeting

- ↳ Minute books of any **General Meeting or of resolution by postal ballot** shall be :
 - (a) Keep at RO of the Co.
 - (b) may be inspected by members during business hours (minimum 2 hrs) without any charge
- ↳ On payment of fees, Copy of minutes to be furnished to member within 7 working days
- ↳ Note :- A member who has requested for soft copy of minutes of any previous General Meeting held during immediately preceding 3 FY shall be entitled to be furnished, with the same free of cost
- ↳ If inspection is refused or copy of minutes is not furnished then penalty payable will be as follows:
 - Co. – Rs. 25000
 - Officer in Default – Rs. 5000
- ↳ In case of such refusal or default, Tribunal may by order:
 - direct an immediate inspection of the minutes books or
 - direct that the copy required shall forthwith be sent to person requiring it

Section 120 : Maintenance and Inspection of Documents in Electronic Form

Any document, register, record, minutes:

- Required to be kept by a Co.** or
- Allowed to be inspected or copies to be given to any person by a Co. under this Act, may be kept or inspected or copies given **in e-form**

Section 121 : Report on AGM

- ↳ Mandatory report on AGM by every listed public Co. including confirmation that AGM was called, held and conducted as per provision of this Act
- ↳ Report Filed by Co. in form MGT-15 with RoC within 30 days of conclusion of AGM
- ↳ Penalty for default
 - Co. – Rs 1 lakh + Rs 500/ day after the first subject to max Rs. 5 lakhs
 - Officer in default – Not less than Rs. 25000 + Rs. 500 / day after the first subject to max Rs. 1 lakh
- Report shall be signed and dated by chairman and CS
In case of his inability of chairman – sign by 2 directors (1 MD, if any) and Co. secretary
- Report shall contain following details :
 - date, day, hour and venue of AGM (details)

- confirmation w.r.t. appointment of chairman of AGM
- no. of members attending AGM
- confirmation of Quorum
- Business transacted and result there of
- confirmation w.r.t. compliance of the Act and Rules, secretarial standard made there under w.r.t. conducting AGM
- particulars w.r.t. any adjournment, postponement of meeting, change in venue
- any other relevant points

Section 122 : Applicability of this chapter to OPC

- Provision of sec 98 and 100 to 111 – not applicable to OPC
- Member Resolution in OPC :
 - resolution is communicated by member to Co.
 - entered in minutes – book
 - signed and dated by member and
 - such date shall be deemed to be the date of meeting for all the purposes under this Act
- ↳ Board Resolution in case of 1 director
 - the resolution entered in minutes book and
 - signed and dated by such director and
 - such date = deemed to be the date of BoD meeting for all the purposes under this Act.

DECLARATION AND PAYMENT OF DIVIDEND

Dividend [Section 2(35)]

- Section 2(35) of the Companies Act, 2013, states that “dividend” includes any interim dividend.
- In simple language, dividend is distribution of profits to its members (equity & preference)

Difference between Interim Dividend and Final Dividend

| Particulars | Interim Dividend | Final Dividend |
|----------------------|--|---|
| Authority | Announced by BOD | Recommended by BOD & declared by shareholders |
| Power in AOA | Authority in AOA required | Authority in AOA not required |
| Time of Announcement | At any time before finalisation of A/cs for the year | In the AGM of the company |
| Revocation | Can be revoked with the consent of all share holders | Cannot be revoked |

Declaration of dividend [Section 123]

1. Source of Dividend

- I. Profits for that FY (Current) arrived after deducting depreciation as per schedule II
- II. Undistributed profits of any previous FYs after deducting depreciation as per Schedule II [i.e. Credit balance in P&L & free Reserves]
- III. Both (I) & (II)
- IV. Money provided by CG or SG for payment of dividend in pursuance of guarantee given by Govt.

Note :- following items shall not be treated as free reserves:

- (a) unrealised gains, notional gains or revaluation of assets
- (b) any change in carrying amount of an asset or liability on measurement at fair value.

2. Transfer to Reserves of the Co.:-

- I. Co. has absolute power to decide
 - a) whether Co. wants to transfer any profits to reserves or not
 - b) % that Co. wants to transfer to reserves

3. Conditions for declaring dividend in case of inadequacy or absence of Profits :- Follow Conditions as per Rule 3 of Companies (Declaration and Payment of Dividend) Rules, 2014

Condition 1:-

Rate of dividend shall not exceed average rate of dividend of 3 immediately preceding FY

Condition shall not apply if Company has not declared any dividend in each of the three preceding financial Years

Condition 2:-

Total Amount drawn from accumulated profits \leq 10% of (Paid up Share capital + free Reserves)

Amount so drawn shall first be utilised to set off the losses incurred in the financial year in which dividend is declared

Condition 3:-

(Free Reserve – Amount drawn for payment of dividend) \geq 15% of Paid up Share Capital

- 4.

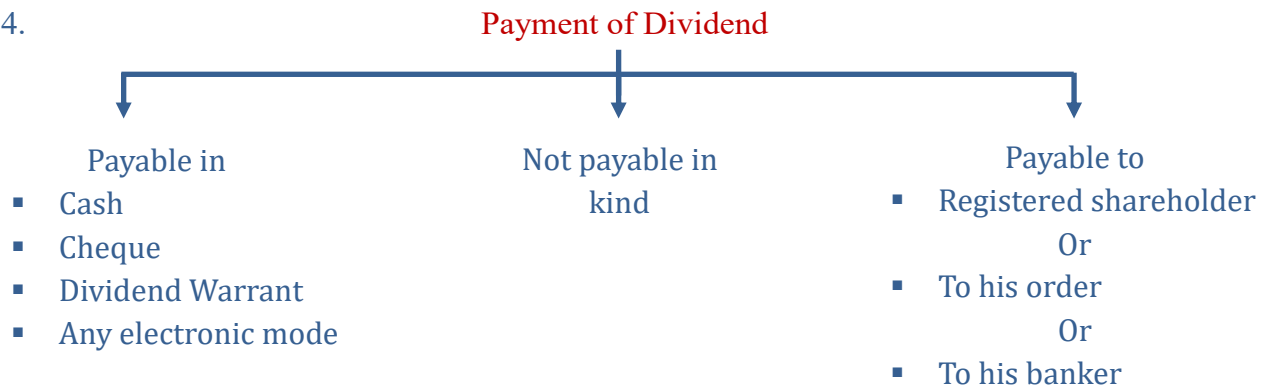

5. Bonus shares cannot be issued in lieu of dividend
6. Sec 8 Co. is prohibited from paying dividend to its members
7. Any Co. which fails to comply with Section 73 or 74 shall not declare any dividend on equity shares, so long the failure continues
8. Board may declare interim dividend during any FY or any time from closure of FY till holding of AGM out of
- Surplus in P&L A/c or
 - Profit of FY for which such interim dividend is sought to be declared or
 - Profits generated in FY till the quarter preceding the date of declaration of interim dividend

Proviso \Rightarrow If Co. has incurred loss during Current FY up to end of quarter immediately preceding the date of declaration, the Maximum Rate of Interim dividend shall not exceed Avg dividend date of immediately preceding 3 FY

Unpaid Dividend Account [Section 124]

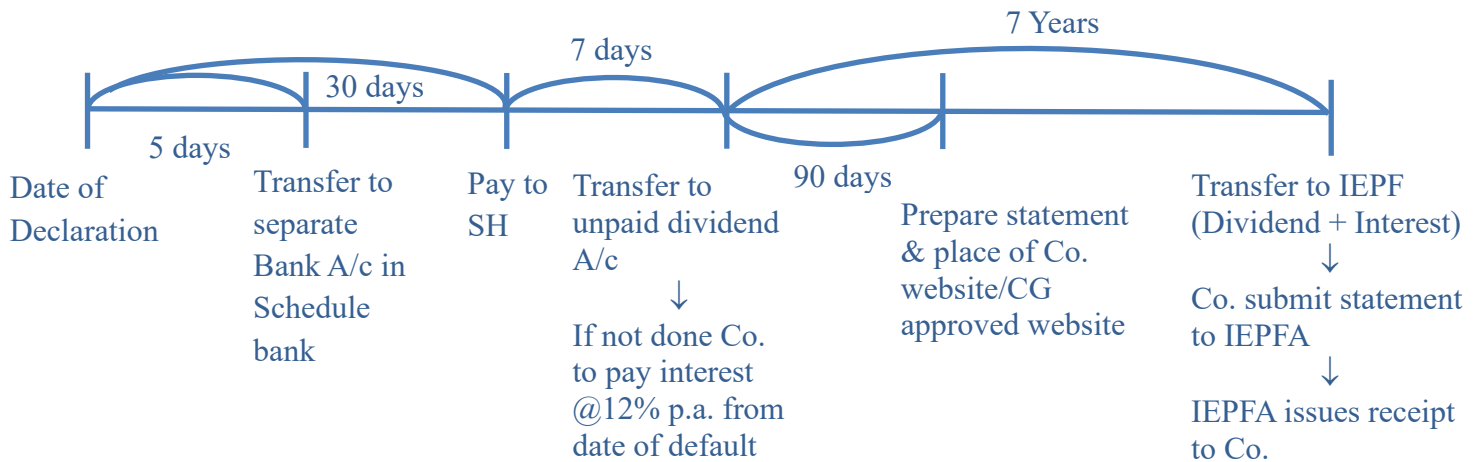

1. Dividend is declared but not paid or claimed within 30 days from date of declaration, then Co. shall within 7 days transfer the unpaid/unclaimed amount of dividend to a special account in scheduled bank called Unpaid dividend A/c.
2. Within 90 days of transferring amount to the Unpaid dividend A/c, Co. to prepare statement containing
 - (a) Name
 - (b) Last known address
 - (c) Unpaid dividend amount
 & place statement on Co. website & other website approved by CG
3. If Co. made default in transferring to Unpaid Dividend A/c
 - The Co. shall pay 12% p.a. interest from date of such default
 - Interest accruing on such amount shall ensure to benefits of members of Co. in proportion to amount remaining unpaid to them.
4. If dividend remains unpaid or unclaimed for 7 years from date of such transfer, then dividend amount along with interest to be transferred to IEPF. Prescribed statement containing details of transfer by Co. to IEPF Authority. IEPF authority to issue receipt to Co. as evidence of such transfer.
5. All shares on which dividend has not been paid/claimed for ≥ 7 consecutive years shall be transferred by Co. in the name of IEPF along with statement containing such details.
6. If dividend is in unpaid dividend A/C, then claimant needs to apply to Co. If dividend is transferred to IEPF, then claimant needs to apply to IEPF authority
7. Claimant of shares shall be entitled to claim the transfer of shares from IEPF with procedure and submission of documents as may be prescribed.

8. Punishment for contravention of this Section :-

| | Co. | Officer in default |
|-------------------------------|--|---|
| Penalty Maximum Penalty | ₹ 1 Lakh & ₹ 500/day after the first ₹ 10 Lakhs | ₹ 25000 & ₹ 100 /day after the first ₹ 2 Lakhs |

Investor Education and Protection Fund [Section 125]

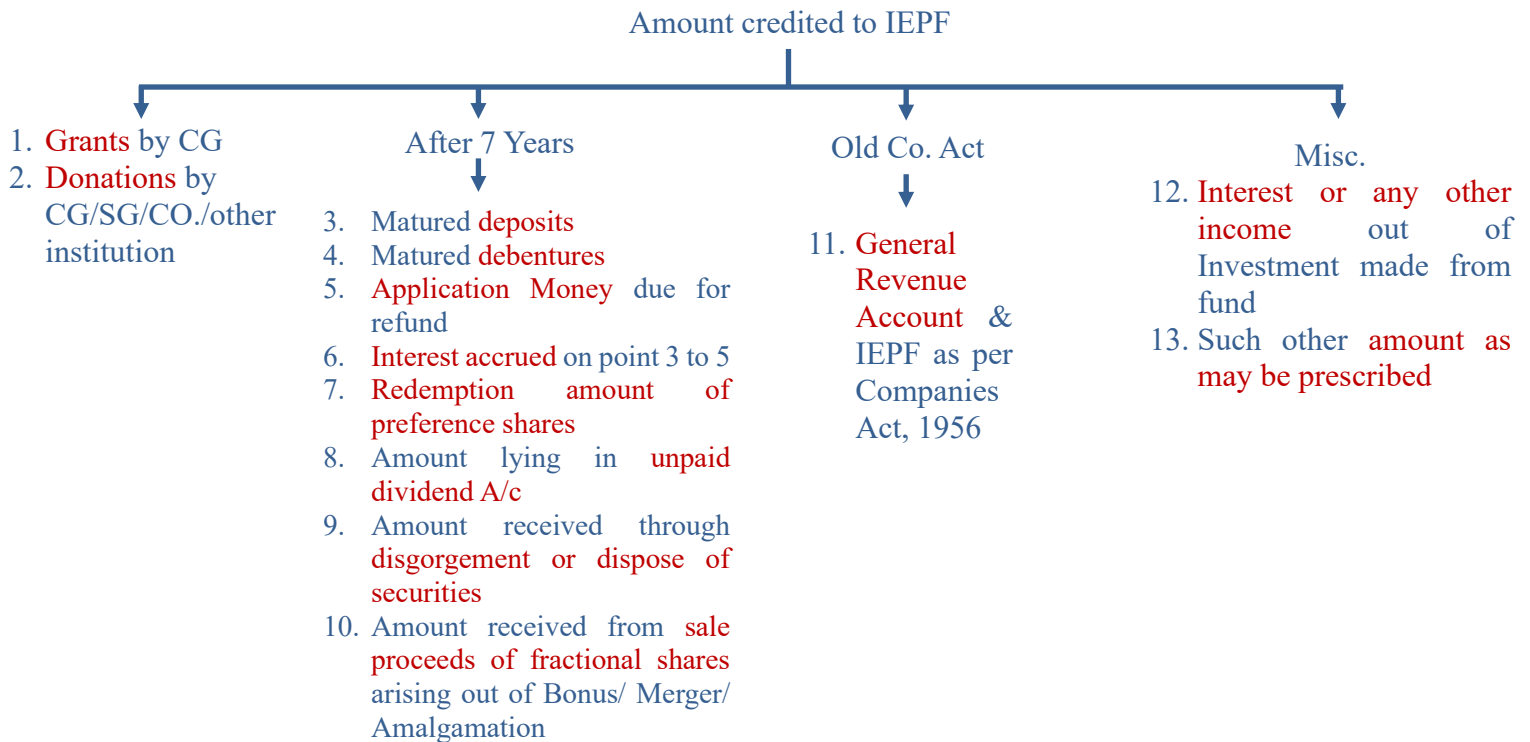

Utilization of IEPF Fund

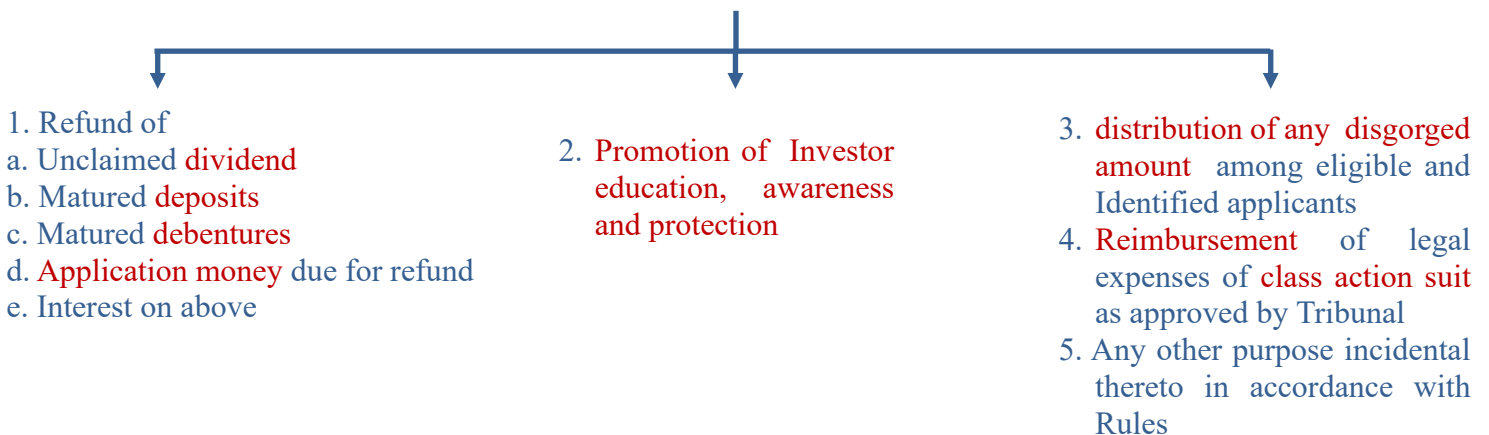

Other provisions governing IEPF :-

1. IEPF authority for administration of fund and maintenance of funds
2. Composition of IEPF Authority
 - a) Chairperson ⇒ Secretary, MCA (Ex-Officio)
 - b) Other 6 Members (Maximum 7 including Chairperson)
 - c) CEO ⇒ Convenor of Authority
3. IEPF authority can spend the money for the purposes allowed
4. Accounts of IEPF audited by Comptroller and Auditor General of India (C&AG)
5. CG establish IEPF and constituted IEPF authority

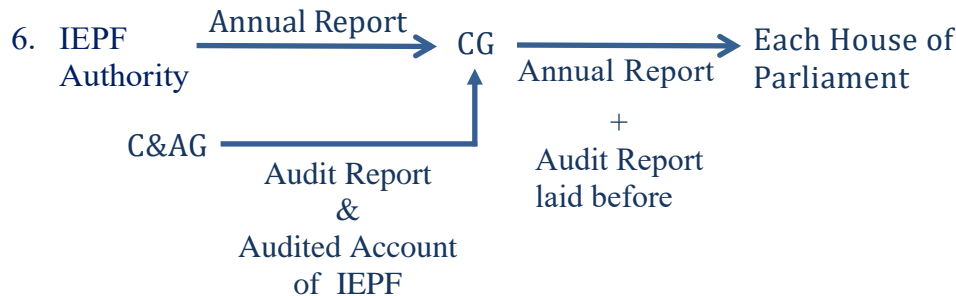

Right to Dividend, Rights Shares and Bonus Shares to be Held in Abeyance Pending Registration of Transfer of Shares. [Section 126]

1. Where any transfer instrument of shares delivered to Co. for registration And such transfer has not been registered by the Co.

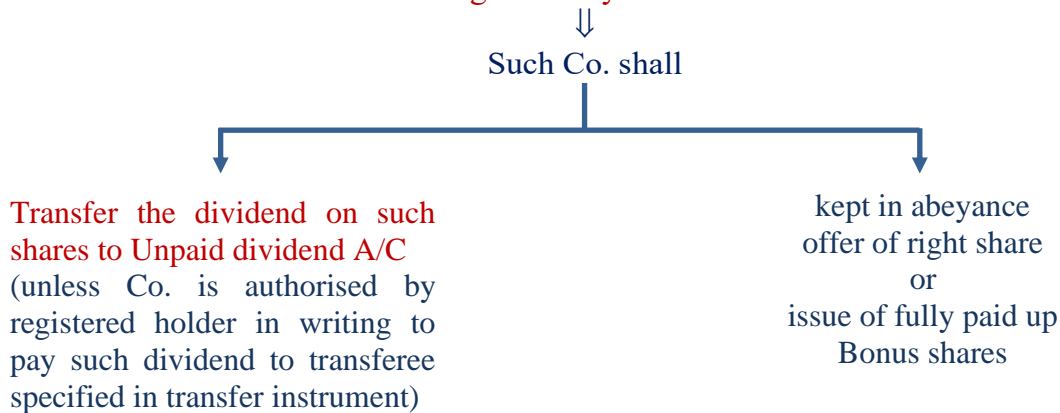

Punishment for failure to pay dividend [Section 127]

1. Where dividend has been declared but dividend has not been paid or warrant has not been posted to entitled shareholder within 30 days of such declaration, then punishment shall be

| Particulars | Every director who is knowing a party to default | Company |
|--|--|----------------------------|
| Imprisonment | Extend to 2 Years And | — |
| Fine-during the period where default continues | Minimum 1000/day – till default continues | Simple interest @ 18% p.a. |

Exception from punishment u/s 127

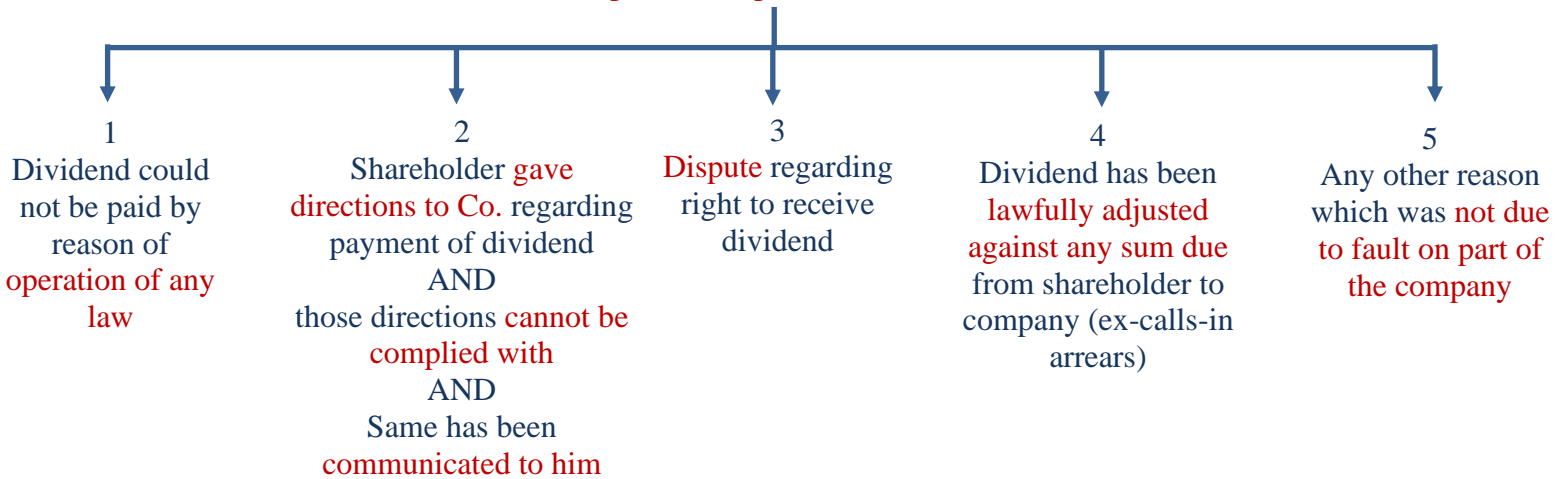

Section 127 dealing with punishment shall apply to the Nidhi Co., subject to the following modification:

In case the dividend payable to a member is Rs.100 or less, it shall be sufficient compliance of the provisions of the section 127, if the declaration of the dividend is announced in the local language in one local newspaper of wide circulation and announcement of the said declaration is also displayed on the notice board of the Nidhi Co. for at least 3 months.

ACCOUNTS OF COMPANIES

Books of Accounts (BOA) [Section 128]

1. Every Co. shall **prepare** and keep
 - **BOA & FS**
 - **at its RO** for every FY
 - **giving true and fair view** of state of affairs of Co.
 - **including its branch office(s) &**
 - **explaining transactions** effected both at the RO and its branches.
2. BOA shall be kept on
 - **accrual basis &**
 - **double entry system** of accounting
3. Place of keeping BOA
 - Normally - **Registered office (RO)**
 - Any **other place in India as BOD may decide** but **inform ROC within 7 days** of decision in Form AOC-5 **giving full address** of such place
4. BOA of branches (In India or o/s India) deemed to be complied if proper **BOA kept at branch office and proper summarised returns periodically sent** to Co. at its RO
5. Who can inspect BOA and other books and papers
 - a) BOA maintained in India
 - open for inspection at RO or other place in India
 - by **any Director**
 - **during business hours**
 - b) BOA maintained **o/s India**
 - **Director furnish request to Co.** setting out
 - full details of information required &
 - period for which it is required
 - **Co. to give info. within 15 days** of written request
 - Such info. shall be sought by **director himself & not by agent/attorney holder/representative**

Note :- A person can inspect the BOA of the subsidiary, only on authorisation by way of the board resolution.
6. Officers & other employees of Co. to give **all assistance** to the person making such inspection **which the Co. may reasonably be expected to give.**
7. Period for which BOA together with voucher to be kept
 - a) If Co. existence for 8 years or more - **Not less than 8 FY** immediately preceding FY
 - b) If Co. in existence less than 8 Years – **for entire period preceding FYs**
 - c) If investigation ordered - **CG may direct BOA to be kept for longer period than 8 years** as it may deem fit and give directions to that effect.
8. Manner of maintaining BOA in e-form
 - a) BOA in e-mode shall remain **accessible in India at all times** as to be usable for subsequent reference

b) Co. using accounting software must have following features in software

recording audit trail
of every transaction

ensuring audit trail
cannot be disabled

Creating edit log of each change
+ date of such change

c) BOA shall be retained completely in original format.

d) Information shall remain complete & unaltered.

e) Information received from branch office shall remain unaltered

f) Information of document should be capable of being displayed in legible form

g) Back-up of such e-records shall be kept in servers physically located in India on a daily basis.

h) Proper system for storage / retrieval / display / printout of e-records

i) Such e-records shall not be disposed of or rendered unusable, unless permitted by law.

j) At the time of filing of FS, Co. shall intimate ROC: -

a) Name of Service provider

b) IP address of service provider

c) Location of service provider

d) where BOA are maintained on cloud, such address as provided by service provider

e) Where service provider is located outside India, the name and address of the person in control of the books of account and other books and papers in India.

9. In case of contravention, following shall be responsible

➤ Managing Director (MD)

➤ Whole Time Director (WTD) in charge of finance

➤ CFO

➤ Any other person charged by BOD with duty of complying with provisions of section 128.

Minimum – Rs. 50,000 and Maximum – Rs. 5,00,000

Financial Statement (FS) [Section 129]

1. FS shall

▪ Give true & fair view of state of affairs of Co.

▪ Comply with Accounting standards (AS) notified u/s 133

▪ be in form as prescribed in Schedule III

2. Items contained in such FS shall be in accordance with AS

3. However, nothing contained in sub-section 1 of section 129 shall apply to

➤ Insurance Co.

➤ Banking Co.

➤ Electricity Co.

➤ Other class of Co. for which format of FS specified in other Act

4. At every AGM, BOD shall lay before such meeting FS for that FY

5. Where FS do not comply with AS, Co. shall disclose in its FS

➤ deviation from AS

➤ Reason for deviation

➤ Financial effect, if any, of such deviation

6. CG may, on its own or on application by Co., exempt any class of companies from complying with this section, if it is considered in public interest.
7. Consolidated FS (CFS)
 - a) If Co. has one or more subsidiaries or associates, then in addition to stand alone FS, Co. shall prepare CFS & lay before AGM along with standalone FS
 - b) CFS shall be in accordance with Sch III + Applicable AS
 - c) If Co. is not required to prepare CFS under AS, it shall be sufficient if it complies with Schedule III.
 - d) Exemption from preparing CFS, if all the below mentioned conditions satisfied:-
 - i. It is wholly / partially owned subsidiary of another Co. & all its other members intimated in writing & they do not object to Co. not presenting CFS
 - ii. Securities are not listed or are not in the process of listing in or o/s India
 - iii. Ultimate or any intermediate holding Co. files CFS with ROC in compliance with applicable AS
 - e) Co. shall also attach a separate statement in Form-AOC-1 containing the salient features of FS of its subsidiary, associates or JV along with its FS.
 - f) The provisions applicable to the preparation, adoption and audit of the FS of a holding Co. shall, mutatis mutandis, also apply to the CFS.
8. If Co. contravenes this Section, following shall be responsible:-
 - MD
 - WTD in charge of finance
 - CFO
 - Any other person charged by BOD with such duty or in absence of any officer mentioned above, all directors

Punishable with Jail ⇒ up to 1 Year or
Fine – Minimum 50,000 to Maximum 500000 or Both

Periodical Financial Results [Section 129A]

- CG may require class or classes of unlisted companies, as may be prescribed
- To prepare financial results of Co. on periodical basis & in prescribed form
 - To obtain approval of BOD
 - Complete audit/ limited review of such results in manner as prescribed
 - File copy with ROC within 30 days of completions of relevant period with prescribed fee.

Re-opening of Accounts on Court's or Tribunal order [Section 130]

1.

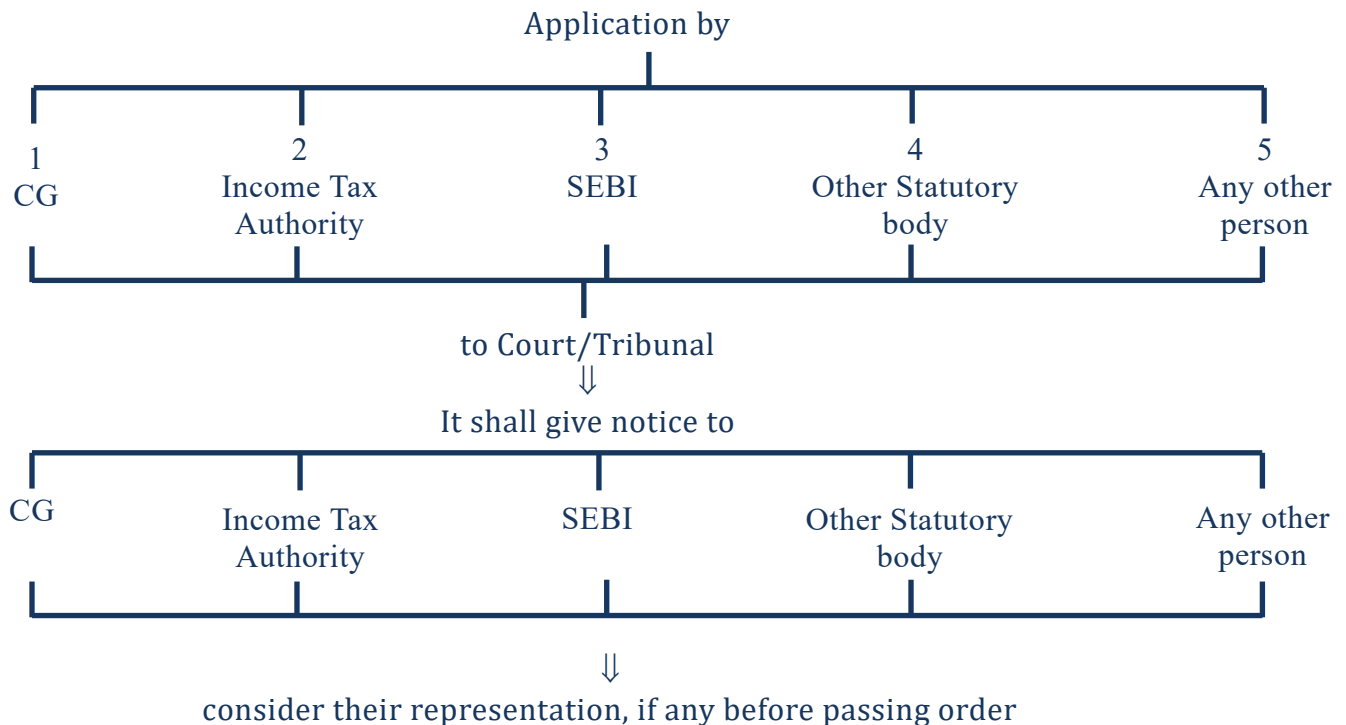

2. Order made by Court or Tribunal to this effect that
 - relevant earlier **accounts were prepared in fraudulent manner** or
 - affairs of Co. were **mismanaged & casting doubt on reliability of FS**
3. The **accounts revised or recast shall be final.**
4. **No Court / Tribunal's order shall be made for reopening of BOA relating to period earlier than 8 FY** immediately preceding current FY.
5. However, if CG has directed for keeping BOA for period > 8 Years, then BOA may be ordered to be re-opened within such longer period.

Voluntary Revision of FS/Board Report [Section 131]

1. If it **appears to directors** of a Co. that
 - a) **FS** do not comply with Section 129 or
 - b) **Board report** do not comply with Section 134
 - they **may prepare revised FS or Board report**
 - in respect of any **3 Preceding FY**
 - after obtaining **approval of Tribunal**
 - on application made by Co.
 - in form **NCLT-1 within 14 days** of the decision taken
 - & copy of **Tribunal's order shall be filed with ROC**

2. Before passing order, Tribunal shall give **notice to CG & ITA** and shall consider their representation if any.
3. Revised FS or Board report shall **not be prepared/ filed more than once** in a FY
4. **Detailed reasons for revision** of such FS or report shall also be **disclosed in Board report of that FY in which revision is being made.**
5. Where copies of previous FS or Board report has been sent to members or delivered to ROC or laid before Co. in GM, then revision must be confined to
 - correction with respect to which previous FS/ report do not comply with provisions of Sec 129 or Sec 134
 - making of any **necessary consequential alteration**
6. Rule 77 of the National Co. Law Tribunal Rules, 2016 requires:
 - (a) The application shall contain the following particulars/details, namely:
 - FY or **period to which such accounts** relates;
 - The name and contact **details of the MD, CFO, directors, CS and officer** of the Co. responsible for making and maintaining such books of account and FS;
 - Where such accounts are audited, the name and contact details of the auditor or any former auditor who audited such accounts;
 - Copy of the **Board resolution;**
 - Grounds for seeking revision** of FS or Board's Report;
 - In case the majority of the directors of Co. or the auditor of the Co. has been changed immediately before the decision is taken to apply under section 131, the Co. shall disclose such facts in the application.
 - (b) The Co. shall **advertise the application at least 14 days** before the date of hearing;
 - (c) The Tribunal shall issue **notice to the auditor of the original FS and heard him.**
 - (d) The Tribunal may pass appropriate order in the matter as may deem fit, after considering the application, hearing the auditor and/or any other person.
 - (e) On receipt of approval from Tribunal, **GM may be called** and notice of such GM along with reasons for change in FS may be published in newspaper in English & vernacular language.
 - (f) In the GM, the **revised FS, statement of directors and the statement of auditors may be put up for consideration** before a decision is taken on adoption of the revised FS.
 - (g) On approval in the GM, the revised FS along with the statement of auditors or revised report of the Board, as the case may be, shall be **filed with the ROC within 30 days of the date of approval** by the GM.

Constitution of NFRA [Section 132]

1. CG may by notification constitute NFRA
2. Functions of National Financial Reporting Authority (NFRA)
 - a) **Recommendation to CG** on formulation & laying down of Accounting & Auditing policies and standards
 - b) **Monitor & Enforce Compliance** with A/c & Auditing Standards
 - c) **Oversee Quality of Service** of professions associated with ensuring compliant of such standard

- d) **Promote awareness** in relation to the compliance of accounting standards and auditing standards;
 - e) **Co-operate with national and international organisations** of independent audit regulators in establishing and overseeing adherence to accounting standards and auditing standards; and
 - f) **Perform such other functions and duties as may be necessary** or incidental to the aforesaid functions and duties.
3. Composition of NFRA
- a) **Chairperson** – appointed by CG having expertise in accountancy, auditing, finance or law
 - b) **Other Members not exceeding 15** - Part time or full time

The following persons shall be appointed as part time members of NFRA, namely:

- a. One member to represent the MCA, who shall be an officer not below the rank of Joint Secretary, ex-officio;
 - b. One member to represent the CAG of India, who shall be an officer not below the rank of Accountant General or Principal Director, ex-officio;
 - c. One member to represent the RBI, who shall be an officer not below the rank of Executive Director, ex-officio;
 - d. One member to represent the SEBI, who shall be an officer not below the rank of Executive Director, ex-officio;
 - e. President, ICAI, ex-officio;
 - f. Chairperson, Accounting Standards Board, ICAI, ex-officio;
 - g. Chairperson, Auditing and Assurance Standards Board, ICAI, ex-officio; and
 - h. Two experts from the field of accountancy, auditing, finance or law.
4. **Each division** of NFRA shall be **presided over**
- **by Chairperson** or
 - **Full time member authorised by chairperson**
5. Executive body of NFRA consisting of chairperson & full-time members of such authority for efficient discharge of its functions
6. Chairperson & members shall give **declaration to CG regarding no conflict of interest or lack of independence**
7. Chairperson & members who are in full-time employment of NFRA shall **not be associated with any audit firm or related consultancy firm during course of such appointment & 2 years after ceasing to hold such appointment**
8. Powers of NFRA to investigate :- The NFRA
- have **power to investigate into matters of professional or other misconducts committed by CA or firm of CA** under CA Act, 1949
 - have power to investigate **suo moto or reference by CG**
 - **No other institute shall initiate or continue any proceedings**, where NFRA has initiated investigation.
 - have same **power as vested in Civil Court.**
 - a) **Discovery and production of BOA** and other documents, at such place and at such time as may be specified by the NFRA;
 - b) **Summoning** and enforcing the attendance of persons and **examining them on oath**;

- c) **Inspection of any books**, registers and other documents of any person referred to in clause (b) at any place;
- d) **Issuing commissions** for examination of witnesses or documents;

9. Penalty by NFRA

a) where professional or other misconduct is proved, NFRA have power to make order for

i. **Imposing Penalty**

| Liabe (in case of) | Minimum | Maximum |
|---------------------------|------------------|-------------------------------|
| Individual | one lakh rupee | 5 times of the fees received |
| Firms | five lakh rupees | 10 times of the fees received |

ii. **Debarring the member/ firm from:-**



10. Any person aggrieved by order of NFRA may prefer an **appeal before Appellate Tribunal (NCLAT)**

11. Scope of NFRA:-

NFRA shall have power to monitor and enforce compliance with AS and auditing standards, oversee the quality of service or undertake investigation of the auditors of the following class of companies and bodies corporate, namely:

- a) Co. whose securities are **listed** on any stock Exchange **in India or outside India**
- b) Unlisted Public Co. having
 - **PUSC** not less than **₹500 Crores** or
 - **Annual T/O** not less than **₹1000 Crores** or
 - **o/s loans / debentures & deposits** of not less than **₹ 500 Crores**
 - as on 31st March of immediately Preceding FY
- c) **Insurance Cos. / banking Cos. / Electricity Cos. / companies governed by special Act**
- d) Any BC / Co. / Person on reference made to NFRA by CG in public interest
- e) BC incorporated or registered outside India, which is subsidiary or associate of any of the above mentioned companies **if the income or net worth** of such subsidiary or associate Co. **exceeds 20% of consolidated in come or consolidated Net worth of such above mentioned Cos.**

12. Accounts of NFRA

- a) BOA ⇒ Maintain in manner prescribed by CG in consultation with C&AG
- b) Audit - **C&AG**
- c) Annual Report ⇒ for each FY giving full A/c of its activities during FY

- d) NFRA ⇒ forward to CG ⇒ CG to lay these reports before each
 ↓
 House of parliament
- A/Cs. as certified by C&AG
 - Auditor's Report
 - Annual Report

CG to prescribe Accounting Standards (AS) [Section 133]

CG may prescribe **AS** or any addendum thereto as recommended by ICAI in consultation with and after examination of the recommendations made by the NFRA.

FS, Board Report etc. [Section 134]

1. Signing of FS & CFS
 - a) Approved by BOD
 - b) Signed on behalf of BOD by
 - Chairperson, if authorised by Board or else 2 Directors (1MD, if any) &
 - CEO & CFO & CS, if appointed
 before it is submitted to auditor for his report thereon.
 In case of OPC - sign by **one director only**
2. Auditor's report & Board's report shall be attached to every FS.
3. Content of Board Report as per Section 134
 - B – Board Meeting's Numbers (Count)
 - O – Order Passed by Court/regulator/Tribunal impacting Going Concern
 - A – Annual Return ka Web Address
 - R – Reported frauds by Auditor
 - D – Director Responsibility Statement
 - R – Resigned/appointed directors during the Year
 - E – Explanation or Comments by Board
 - P – Particulars or Contracts or arrangement with Related Parties (AOC-2)
 - O – Organization's State of Affairs
 - R – Revision (changes) from date of closure of FY in nature of business
 - T – The Financial summary or highlights
 - other matters as may be prescribed
4. In case of OPC, Board report mean a report containing explanations or comments by the Board on every qualification, reservation or adverse remark or disclaimer made by auditor in his report
5. Director's responsibility statement
 - a) in preparation of annual accounts, the applicable AS had been followed along with proper explanation relating to material departures
 - b) Directors had selected such accounting policies and applied them consistently and made judgements and estimates that are reasonable and prudent

- c) Directors had taken proper and sufficient care for:-
 - the maintenance of adequate accounting records as per his Act
 - safeguarding the assets of the Co.
 - for preventing & detecting fraud & other irregularities
 - d) directors had prepared the annual accounts on a going concern basis
 - e) In case of listed Co., directors had laid down Internal Financial controls (IFC) to be followed by Co. & such IFC are adequate & were operating effectively.
 - f) Directors had devised proper systems to ensure compliance with the provisions of all applicable laws & that such systems were adequate & operating effectively.
6. Signing of Board Report
- Chairman, (if authorized by Board) or else
 - 2 Directors (1 MD, If any)
- In case of Co., having only 1 Director, then it shall be signed by such 1 Director
7. If Co. is in default in complying this section,

| Persons liable | Punishment |
|--|------------|
| Co. | ₹ 3,00,000 |
| Every officer of the Co. who is in default | ₹ 50,000 |

Right of member to copies of audited FS [Section 136]

1. Copy of following docs laid before AGM
- FS
 - CFS, if any
 - auditor's Report
 - every other documents required to attach to FS
- } shall be sent to
- Every Member
 - Trustee for Debenture holders
 - All other entitled person
- not less than 21 days before date meeting

2. Notice with period less than 21 days is valid if if agreed by members

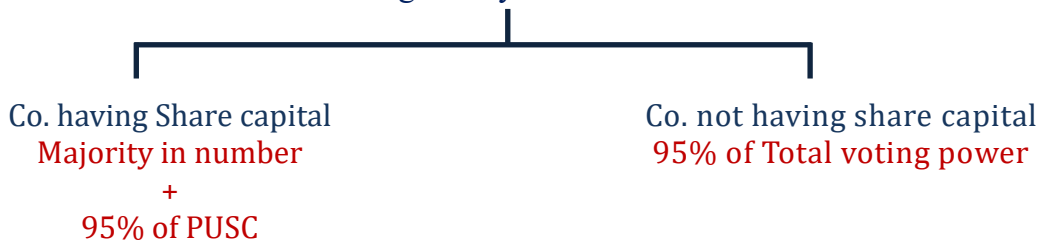

3. Mode of Sending Notice

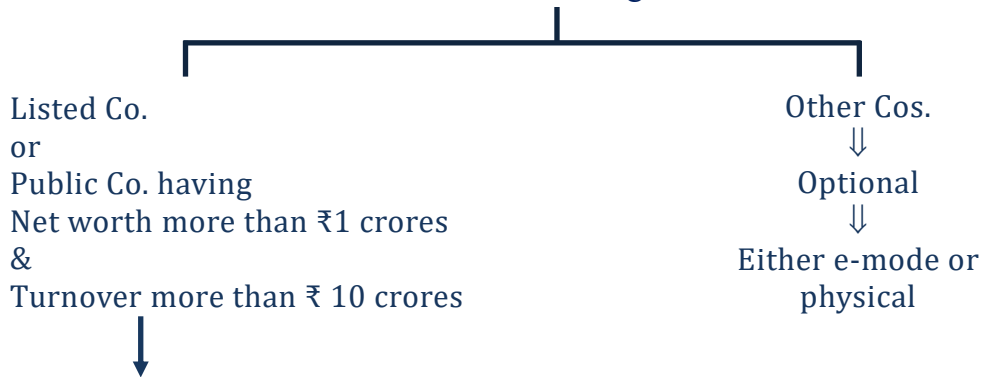

| Shareholding is in | Mode |
|---|--|
| 1. Demat + email registered | E-Mode |
| 2. Physical form but members consented for e-mode | E-Mode |
| 3. All other cases | Dispatch of physical copies through recognised mode u/s 20 |

4. Important points for listed Cos.

- a) If copies of docs are made available for inspection at RO during working hours for 21 days before date of meeting & Statement containing salient features of such docs or copies thereof is sent to member, Debenture trustee in form AOC-3/3A not less than 21 days before date of meeting unless shareholders ask for full FS.
 - b) Listed Co. shall also place its FS including CFS & other docs on its website
 - c) Listed Co. having subsidiary shall place separate audited a/cs of each of subsidiary on its website
 - d) If foreign subsidiary of listed Co. is required to prepare CFS, then proviso is complied if such CFS is placed on website of listed Co.
 - e) If foreign subsidiary of listed Co. is not required to get FS audited, then listed Co. may place unaudited FS on website.
 - f) Where FS of foreign subsidiary is in language other than English, place a translated copy in English language on the website.
5. Co. shall allow members / DT to inspect the documents at its RO during business hours
 6. Every Co. having subsidiary shall provide a copy of separate audited or unaudited FS to any member of Co. who ask for it
 7. Default in complying with section
 - Co. - Liable to Penalty of ₹ 25000
 - Officer in default - Liable to Penalty of ₹ 5000

Copy of FS to be filed with ROC [Section 137]

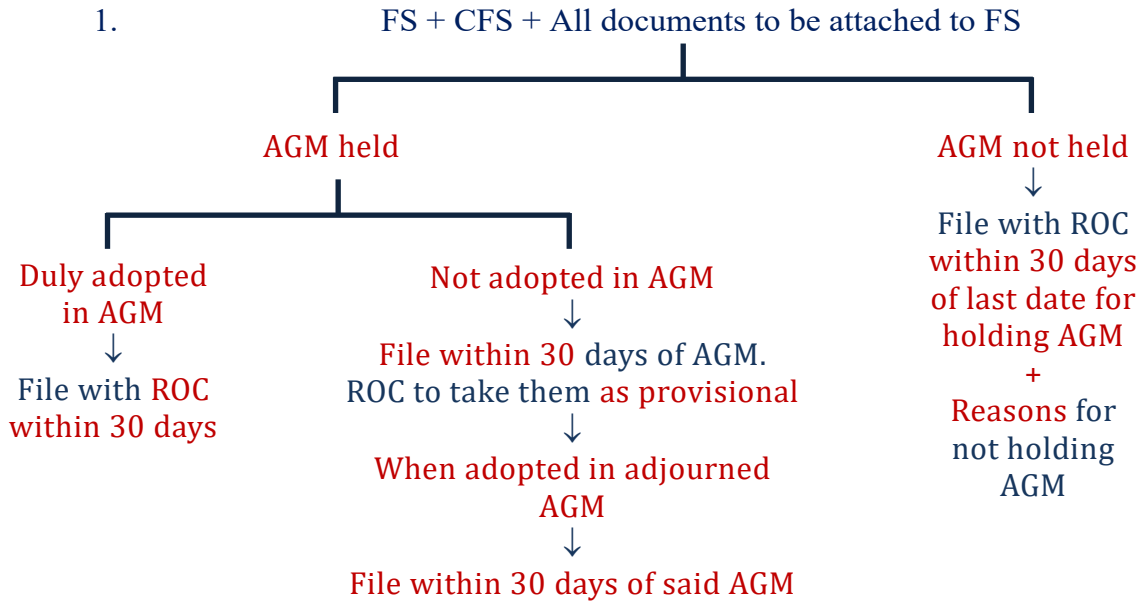

2. Forms for filing FS with ROC

| | |
|--------------------|------------------------------|
| AOC-4 | FS & other docs |
| AOC-4 CFS | Consolidated FS |
| AOC-4-NBFC(Ind As) | NBFC to file FS & other docs |
| AOC-4-NBFC(Ind As) | NBFC to file CFS |

3. Following class of Cos. shall file FS & other docs in e-form AOC-4-XBRL

- Co. listed in India & their Indian Subsidiary
- Co. having PUSC >= 5 Crores.
- Co. having T/O >= 100 Crores
- Co required to prepare FS as per Ind AS

Note:- Once Co. falls under above Category, it continue to file AOC-4 XBRL forever

4. Along with FS, Co. shall attach accounts of its subsidiaries incorporated o/s India & which have not established their place of business in India.
5. In case of OPC, file copy of FS duly adopted by its member within 180 days from closure of FY.
6. In case of subsidiary incorporated o/s India which is not required to get FS audited under law of such country, then holding Indian Co. to file unaudited FS + declaration to such effect to ROC.
7. Where FS is in language other than English translated copy to be sent to ROC.

8. Co. fails to file copy of FS

| Person liable | Penalty |
|--|---|
| Company | Fine of ₹ 10,000 and In case of continuing failure, further penalty of ₹ 100/day during which such failure continues, maximum of ₹ 2 lakh. |
| MD and CFO of the Co., if any; <i>In their absence</i> | Fine of ₹ 10,000 and In case of continuing failure, further penalty of Rs. 100 /day maximum ₹ 50,000. |
| Any other director who is charged by the Board with the responsibility; <i>In its absence</i> | |
| All the directors of the Co.. | |

Internal Audit [Section 138]

1. Co. covered under ambit of Internal audit

| Listed Co. | Unlisted Public Co. | Private Co. |
|------------|---|-------------|
| All | 1. Turnover \geq 200 Crores 2. Outstanding loans or borrowings from banks or PFIs exceeds ₹ 100 Crores | |
| | 3. PUSC \geq ₹ 50 Crores 4. O/s deposits \geq ₹ 25 Crores | – – |

2. Who can become an internal auditor?

- Individual
- Partnership firm
- Body Corporate
- CA
- Cost Accountant
- other professional as may be decided by BOD

3. Internal auditor may or may not be an employee of Co.

Corporate Social Responsibility [Section 135]

1. Applicability of CSR :-

Co. having

Net worth \geq ₹ 500 Crores or
 Turnover \geq ₹ 1000 Crores or
 Net profit \geq ₹ 5 Crores

during immediately
preceding FY

shall constitute CSR committee having composition

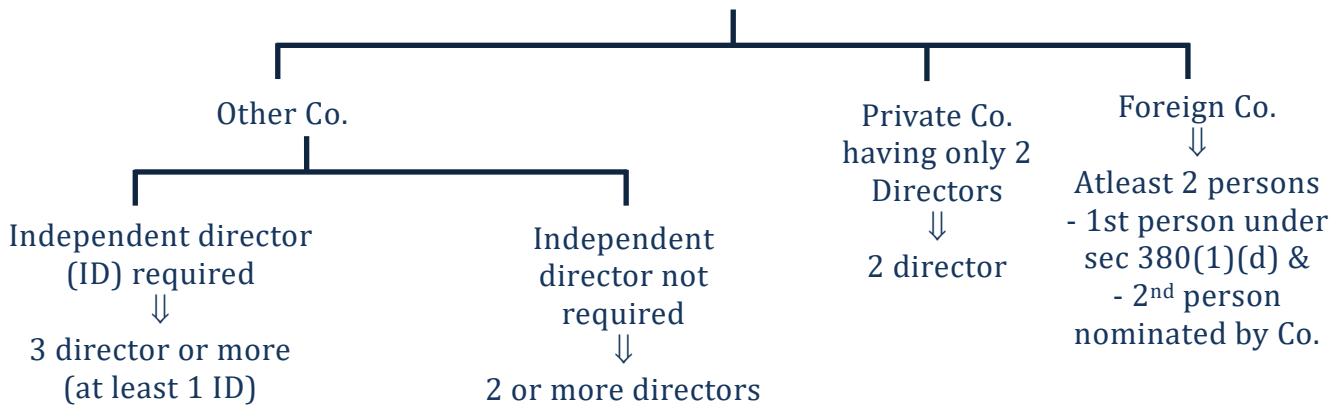

2. If the amount to be spent by Co. \leq ₹ 50 Lakhs, then CSR committee shall not be required. In such case, function of CSR committee to be discharged by Board.

3. Board report to disclose composition of CSR committee

4. CSR Expenditure

a) Board shall ensure that the Co. spends

- in every FY
- 2% of average net profits
- made during 3 immediately preceding FYs

b) If Co. has not completed 3 FY since incorporation, then take at least 2% of average of immediately preceding FYs

c) While spending CSR amount, Co. shall give preference to local area & areas around it where it operates

d) Board shall ensure that admin overheads shall not exceed 5% of total CSR Expense for the FY.

e) Any surplus arising out of CSR activities shall: -

- not form part of business profit &
- shall be ploughed back in same project or
- transfer to unspent CSR A/C & spent in pursuance of CSR or
- Transfer to fund specified in Sch VII, within 6 months of expiry of FY.

5. Co. to spent 2% a/v profit of last 3 FYs

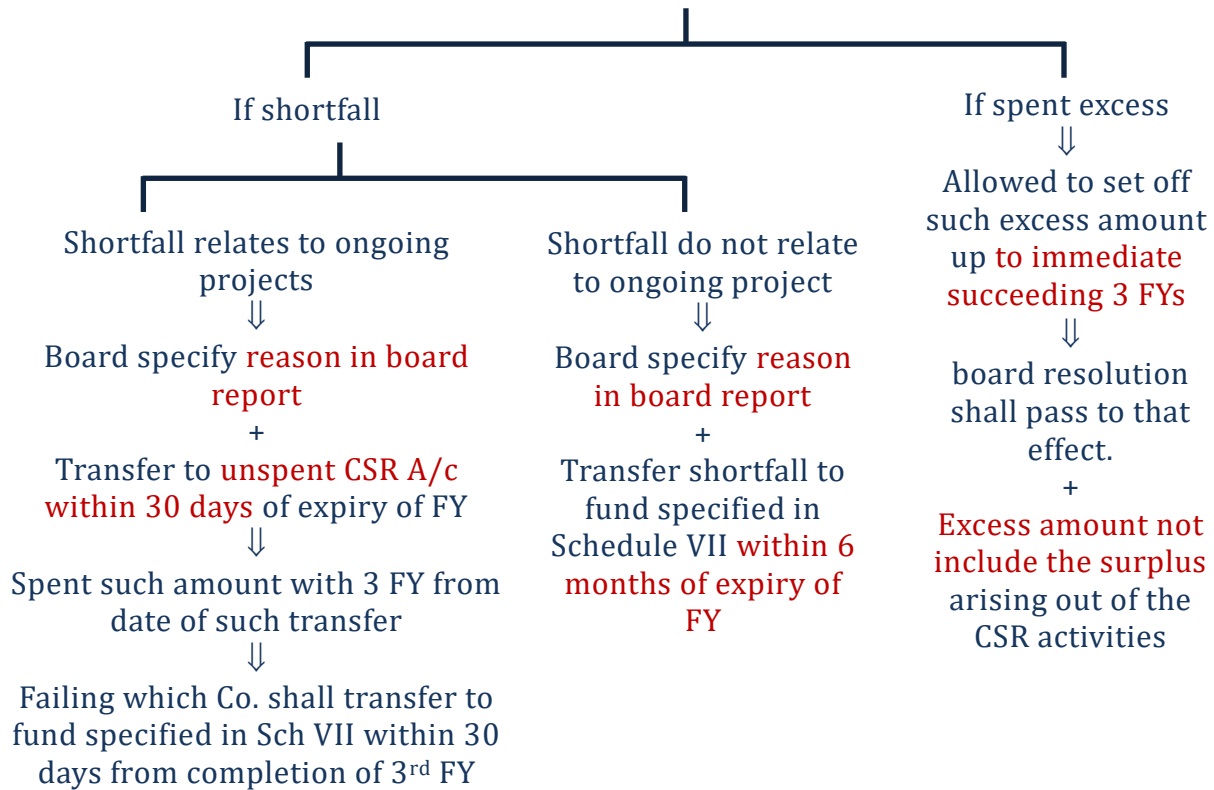

6. Default u/s 135(5) or 135(6)

| | |
|--|--|
| <p>For Co. Lower of</p> <p>a) 2 × (amt. required to transfer to fund or unspent A/C)</p> <p>b) ₹ 1 Crore</p> | <p>For Officer in default Lower of</p> <p>a) 1/10th of (amt. required to transfer to fund or unspent A/C)</p> <p>b) ₹ 2 Lakhs</p> |
|--|--|

7. CSR amount may be spent by a Co. for creation or acquisition of a capital asset, which shall be held by -

- a. A Co. established under section 8 of the Act, or a Registered Public Trust or Registered Society, having charitable objects and CSR Registration Number; or
- b. Beneficiaries of the said CSR project, in the form of self-help groups, collectives, entities; or
- c. A Public Authority

8. Implementation of CSR projects
CSR activities are undertaken by

- a) Co. itself or
- b) through Section 8 Co. or Registered Public Trust or Registered society established by Co. alone or along with any other Co. or By CG or By SG or

- c) any **statutory body** established under Act of Parliament or state legislature
 - d) A Co. established under section 8 of the Act, or a registered public trust or a registered society having an established track record of at **least three years in undertaking similar activities**.
9. A Co. may also **collaborate with other Companies** for undertaking projects provided respective Cos. are in a **position to report separately on such project**.
10. Impact Assessment
- (a) Every Co. having **avg CSR obligation \geq ₹ 10 Crores in 3 immediately Preceding FYS** shall
 - undertake impact assessment
 - through **independent agency**
 - of CSR projects having **outlays \geq ₹ 1 Crores &**
 - which have been **completed not less than 1 Year before** undertaking the impact study
 - b) Impact assessment reports - placed before BOD & annexed to annual report on CSR
 - c) **Maximum amount** on impact assessment
Higher of 2% of total CSR exp or ₹ 50 lakhs
11. A Co. may **engage international organizations** for designing, monitoring and evaluation of **the CSR projects** as well as for capacity building of their own personnel for CSR.
12. Expenditure **incurred by Foreign Holding Co.** for CSR activities in India will qualify as CSR spending of the Indian subsidiary, if, the CSR expenditures **are routed through Indian subsidiaries** and if the Indian subsidiary is required to do so as per section 135 of the Act.
13. CSR shall not include: -
- (a) Activities undertaken in pursuance of **normal course of business** of the company
 - (b) Any **activity undertaken by the company outside India** except for training of **Indian sports personnel** representing any State or Union territory at national level or India at international level
 - (c) Contribution of any **amount directly or indirectly to any political party** under section 182 of the Act
 - (d) **Activities benefitting employees** of the company as defined in clause (k) of section 2 of the Code on Wages, 2019
 - (e) Activities supported by the companies on **sponsorship basis** for deriving marketing benefits for its products or services
 - (f) Activities carried out for fulfilment of any other statutory obligations under any law in force in India.
14. **Net profit means the net profit of a company as per its financial statement** prepared in accordance with provisions of section 198 of the Act, and **but shall not include** the following, namely: -
1. Any **profit arising from any overseas branch or branches** of the company, whether operated as a separate company or otherwise; and
 2. Any **dividend received from other companies** in India, which are **covered under** and complying with the provisions of **section 135 of the Act**.

Note :- In case of a foreign company, net profit means net profit as per profit and loss a/c prepared in terms of section 381(1)(a) read with section 198.(Indian operations only)

AUDIT AND AUDITORS

Eligibility, Qualifications & Disqualifications of Auditor [Section 141]

- (1) Following persons are eligible for becoming Auditor of a Co.
 - (a) Individual CA having certificate of practice
 - (b) Firm including LLP in which majority of Partners are CAs practicing in India
- (2) Signing on behalf of firm – only partners who are CAs authorised to act and sign on behalf of firm
- (3) If the person incurs any disqualification after appointment,
 - ⇒ He shall vacate his office
 - ⇒ It shall deemed to be causal vacancy

Disqualifications

- (a) Body Corporate (other than LLP)
- (b) Officer or employee of the Co.
- (c) Person who is partner or employee of officer or employee of the Co.
- (d)

| | | |
|---|---|---|
| <ul style="list-style-type: none"> - Person or - His relative or - His partner | <ol style="list-style-type: none"> (a) Holding any security in (b) Is indebted exceeding ₹5 lakh to (c) Had given guarantee or security with respect to indebtedness of 3rd person exceeding ₹1 lakh to | Co. or Subsidiary or Holding Or Associate Co. or Subsidiary of Holding Co. |
|---|---|---|

Note : Relative may hold security in Co. of face value not exceeding ₹ 1 Lakhs

Note : If relative acquires security above ₹1 lakh, then corrective action within 60 days of such acquisition or interest.

- (e) Person or firm who, whether directly or indirectly, has business relationship with CASH or Subsidiary of Holding or subsidiary of Associate Co.
What is business relation?
Any transaction entered into for a commercial purpose, except
 - (a) Transactions in ordinary course of business of Co. at arm's length price
 - (b) Transactions which are in the nature of professional services permitted to be rendered by auditor or audit firm
- (f) Person whose relative is a director or in the employment of Co. as a director or KMP
- (g) A person who is in full time employment elsewhere or a person or partner of firm holding appointment as auditor, holding audit of >20 Cos. at the date of appointment or reappointment

Notes – OPC, small Co. dormant Co. & Pvt. Co. having PUSC < ₹ 100 Crores not counted for limit of 20

⇒ In case of firm, the limit of 20 shall be for each partner who is CA

- (h) Person convicted by court of offence involving fraud and 10 years has not been lapsed from date of such conviction
- (i) Person who, directly or indirectly, render services referred in Section 144 to Co., or holding Co. or subsidiary Co. (Note – Associate Co. is not covered)

Auditor not to render certain services [Section 144]

- (1) Auditor can provide services to Co. which are approved by Audit committee/BoD
- (2) But such services shall not include following services (directly or indirectly) to CaSH
 - (a) Accounting and book keeping services
 - (b) Internal Audit
 - (c) Design & implementation of any financial info. System
 - (d) Actuarial services
 - (e) Investment advisory & banking services
 - (f) Rendering of outsourced financial services
 - (g) Management services
 - (h) other kind of services as may be prescribed (Not yet prescribed)

Relative [Section 2(77)]

Relative means any one who is related to another if

- (a) They are members of HUF
- (b) They are husband & wife
- (c) One person is related to other in such manner as may be prescribed (refer chart)

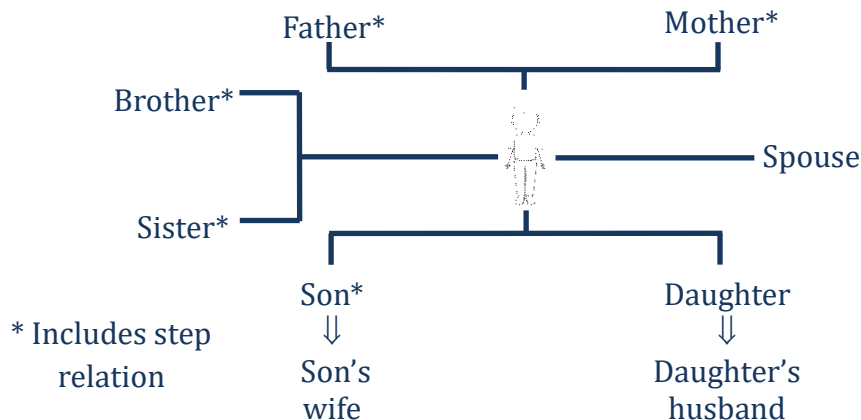

Appointment of Auditors [Section 139]

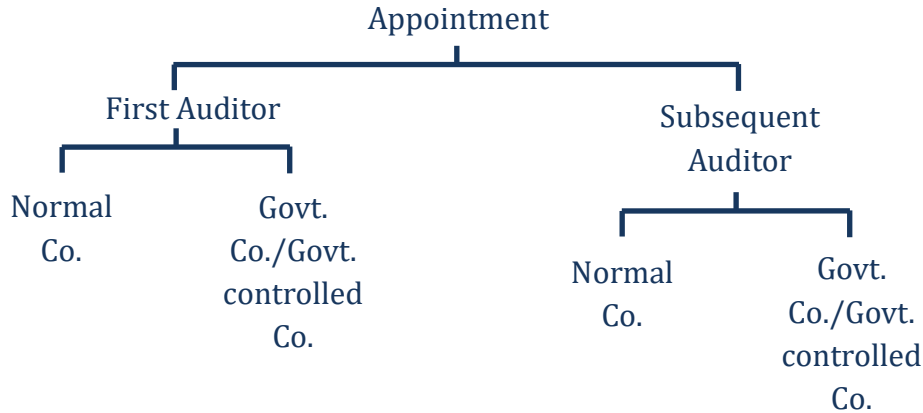

(2) First Auditor of Co. other than Govt. Co. Govt. owned or Controlled



- (1) Appointed by board within 30 days from registration of Co.
- (2) Failure of Board,
 - Board shall inform Members
 - Member shall within 90 days appoint auditor at EGM
- (3) Tenure ⇒ Auditor should hold office till conclusion of first AGM.

(3) First Auditor in Govt. Co./Govt. owned or Controlled

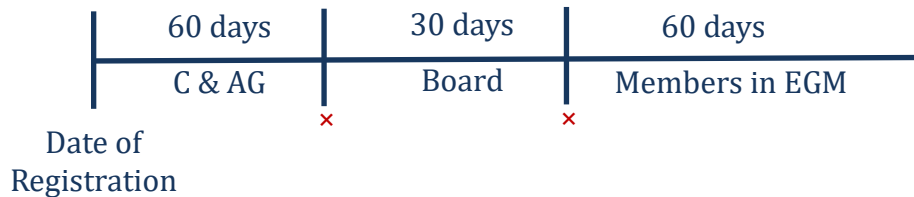

- (a) Appointed by C&AG within 60 days from date or registration of Co.
- (b) Failure of C&AG, Board shall appoint within next 30 days

- (c) Failure of Board, Board shall **inform members, who shall appoint auditor within 60 days at EGM.**
- (d) First Auditor should **hold office till the conclusion of first AGM.**
- (4) Subsequent Auditor of Govt. Co/Govt. Owned or Controlled Co.
 - (a) For **every FY, C&AG shall appoint auditor within a period of 180 days from commencement of FY**
 - (b) Tenure \Rightarrow Auditor shall hold **office till conclusion of AGM.**
- (5) Subsequent Auditor in case of Co. (other than Govt. Co.)

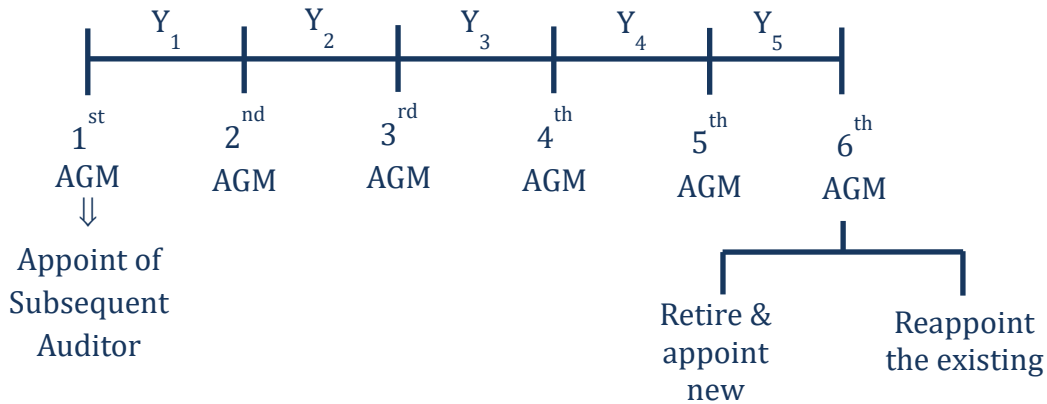

- (a) Co. shall **appoint auditor at 1st AGM who shall hold office till conclusion of 6th AGM.**
 - (b) **Thereafter till conclusion of every 6th AGM**
 - (c) Selection procedure if Co. is required to constitute Audit Committee
- Note :- Audit committee is required to be formed by prescribed Co. u/s 177.*

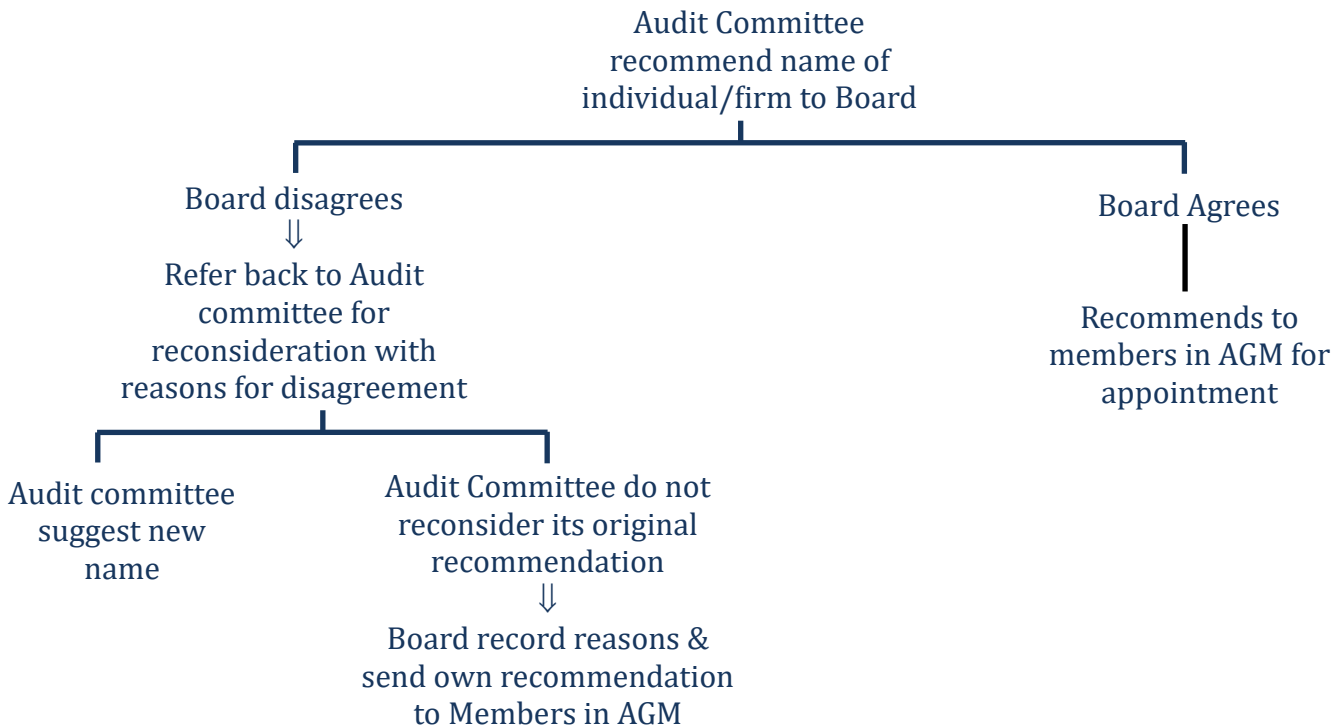

If Co. is not required to constitute Audit committee, then Board shall consider and recommend name of Individual /firm to members in AGM for appointment

- (5) Before appointment of auditor
 - (a) **Written consent of Auditor** is required
 - (b) **Certificate from auditor** that individual/firm is
 - (i) **Eligible for appointment & not disqualified** under CA, 2013, Chartered Accountant Act, 1949
 - (ii) Appointment as per **term provided under this Act**
 - (iii) Appointment is **within the limit under the Act**
 - (iv) **List of Pending proceedings against auditor/audit firm/ any partner of firm w.r.t. profession misconduct as disclosed in certificate is true & correct.**
- (6) After appointment of auditor, the Co. shall
 - (a) **Inform Auditor** of his appointment
 - (b) File **notice (Form ADT-1) of appointment with ROC within 15 days** of meeting in which auditor is appointed
- (7) Rotation of Auditors
 - (1) Rotation of Auditors is applicable to below mentioned Co.
 - (a) **Listed Co.**
 - (b) **Unlisted Public Co.** – PUSC \geq ₹ 10 Crores
 - (c) **Private Cos** – PUSC \geq ₹ 50 Crores
 - (d) Any Co. having **public borrowing from FI/Banks/Public deposits \geq 50 Crores**

Note :- OPC, Small Co. Dormant Co. are exempt from rotation provisions
 - (2) Cooling Period :- **Individual** who has **completed 1 term of 5 consecutive years** or **firm/llp** who has **completed 2 terms of 5 consecutive years** shall not be eligible for re-appointment as auditor in **same company for 5 years**
 - (3) **No audit firm having a common partner** to the other Audit firm whose tenure has expired, shall be appointed as auditor of the same Co. for period of 5 years.
 - (4) Break in term for Continuous 5 years shall be considered as fulfilling requirement of rotation.
 - (5) Partner, who is in charge of Audit Firm & also certifies the FS, retires from said firm & joins any other firm of CAs, other firm shall also be ineligible to be appointed for period of 5 years.
 - (6) **Same Network Entity also not allowed to Audit**
 - (7) Can retiring auditor take audit of subsidiary/holding Co.?? \Rightarrow Yes
 - (8) **Any other Audit (Tax Audit/Internal Audit) or other services in cooling period is allowed. Only statutory Audit is not allowed.**

(9) Transition Provisions:-

| Firm/LLP | | | Individual Auditor | | |
|-----------------|--|--------------|--------------------|---|--------------|
| Existing Tenure | Max ^m Tenure after sect 139 (2) | Total Tenure | Existing Tenure | Future Max ^m Tenure after sec. 139 (2) | Total Tenure |
| 10 or More | 3 | 13 | 5 or more | 3 | 8 |
| 9 | 3 | 12 | 4 | 3 | 7 |
| 8 | 3 | 11 | 3 | 3 | 6 |
| 7 | 3 | 10 | 2 | 3 | 5 |
| 6 | 4 | 10 | 1 | 4 | 5 |
| 5 | 5 | 10 | | | |
| 4 | 6 | 10 | | | |
| 3 | 7 | 10 | | | |
| 2 | 8 | 10 | | | |
| 1 | 9 | 10 | | | |

- (10) **Members of a Co. may resolve that**
 (a) **Auditing partner & his team shall be rotated** at such intervals may be resolved by members
 or
 (b) Audit shall be conducted by **more than one Auditor.**

- (11) Casual vacancy
 Reasons for casual vacancy (CV)
 • Disqualification
 • Resignation
 • Death/Unsound mind/Insolvent
 • Removal

Filling of CV

| | |
|---|--|
| (a) Other than Govt. Co./Govt. Controlled Co. | By BOD – within 30 days of CV If resignation : - App. to be approved (OR) at GM within 3M of BOD recommendation ⇒ Hold office Till Conclusion of Next AGM |
| (b) Govt. Co/Govt. Controlled Co. | ⇒ By C&AG within 30 days ⇒ If C&AG fails ⇒ BoD to fill within next 30 days ⇒ Hold office till conclusion of Next AGM. |

- (12) Retiring Auditor may be re-appointed at AGM, if
- He is **not disqualified** for re-appointment
 - He has **not given a notice of unwillingness** to be appointed in writing
 - SR has not been passed** at meeting
 - to appoint some other auditor
 - or
 - providing expressly that **he shall not be re-appointed**
- (13) Where at any AGM, no auditor is appointed or re-appointed, the existing auditor shall continue to be the auditor of the Co.
- (14) Where a Co. is required to constitute Audit Committee then then all appointment of auditor including filling of casual vacancy shall be made after taking recommendations of Audit Committee.

Removal of Auditor [Section 140(1)]

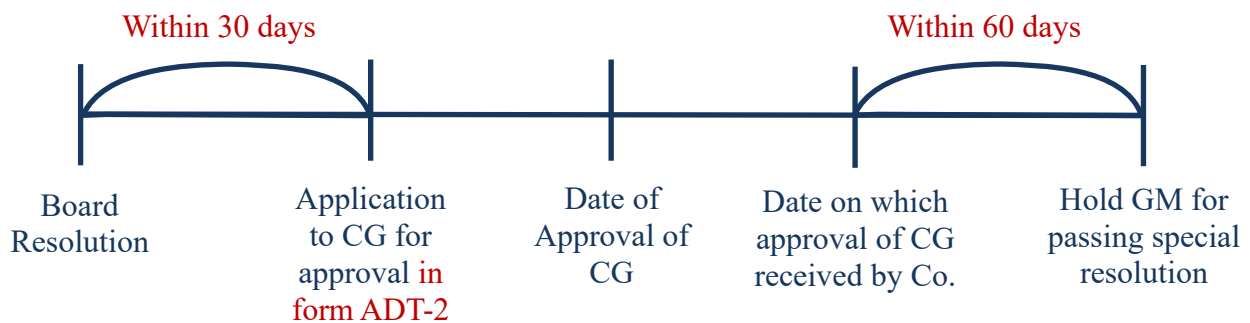

- Before Removal, Auditor shall be given reasonable opportunity of being heard
- On removal of Auditor before expiry of his term, casual vacancy will be created & filled as per section 139

Resignation of Auditor [Section 140(2)]

- Auditor who resigned shall file statement in form ADT-3 within 30 days from date of resignation with – Co.
– RoC
– C&AG (only in case of Govt. Co.)
- ADT-3 contains reasons and other facts relevant to resignation
- Penalty on Auditor– Lower of ₹ 50000 or amount equal to remuneration Further Penalty in case of continuing failure ⇒ ₹ 500/ day after the first maximum ₹ 2 Lakhs

Special Notice [Section 140(4)]

- (1) **Special Notice** shall be required for resolution at AGM for
 - (i) **appointing a person other than retiring auditor**
or
 - (ii) providing expressly **that retiring auditor shall not be re-appointed**, except where retiring auditor has completed tenure of 5/10 years.
- (2) Procedure of special Notice is given in Section 115
- (3) On receipt of special Notice by Co., it shall immediately send copy of notice to retiring auditor
- (4)

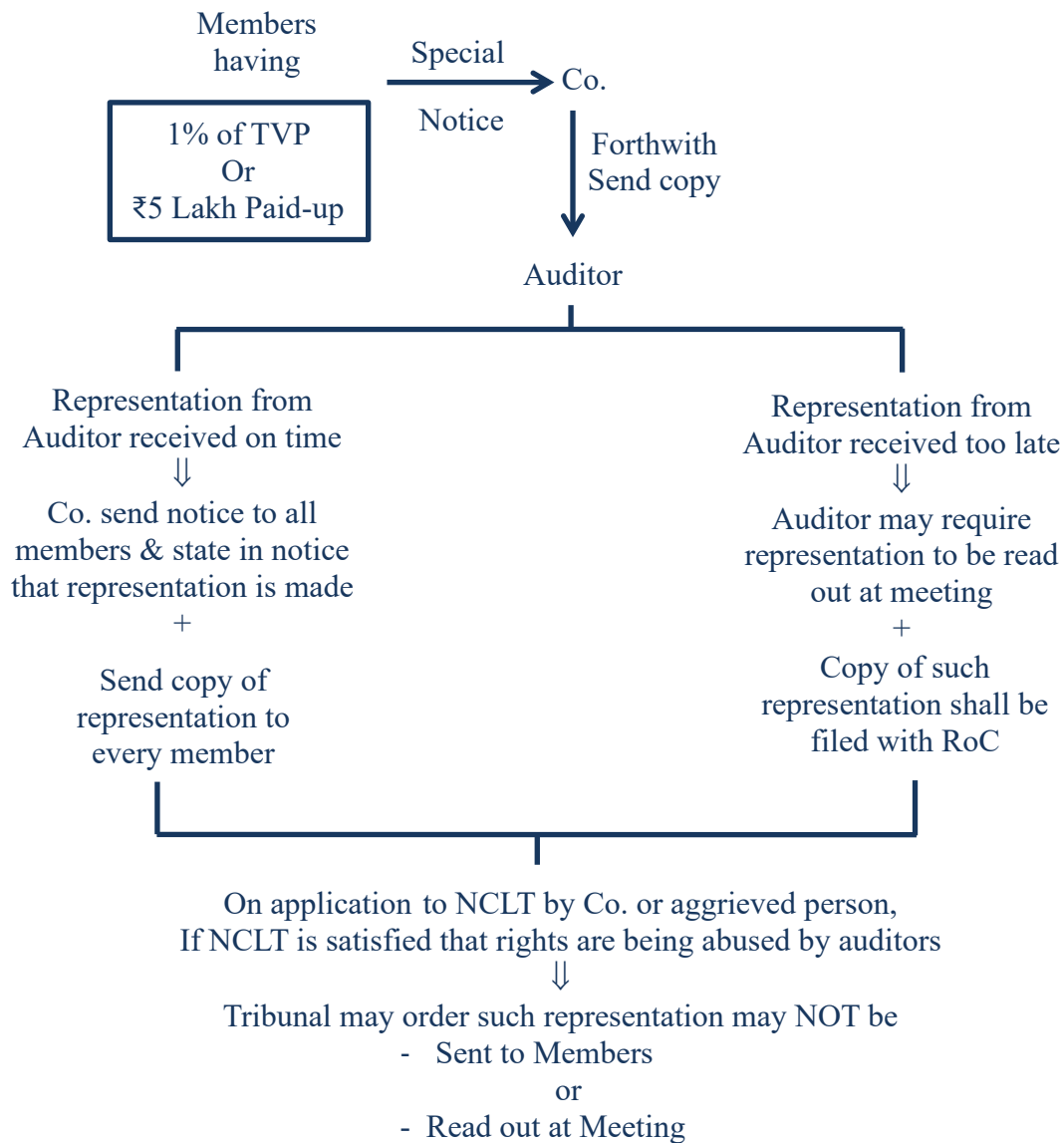

Tribunal may order to change auditor [Section 140(5)]

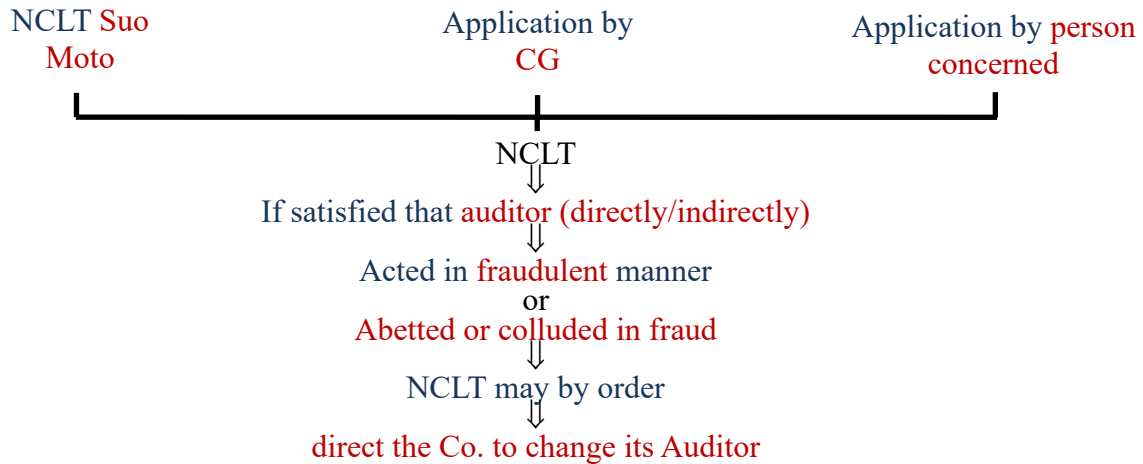

Note:- Removed auditor not eligible to be appointed as auditor of any Co. for 5 years & liable under sec. 447

- If application is made by CG & NCLT is satisfied that auditor change is required, then within 15 days of receipt of application, NCLT shall make an order that :
He shall not function as auditor & CG may appoint another auditor in his place.

Remuneration of Auditor [Section 142]

- (1) Remuneration to be fixed at GM or in manner as may be determined in GM.
- (2) Board may fix remuneration of first auditor appointed by Board.
- (3) In addition to fees, remuneration include
 - expenses incurred by auditor in connection with such audit (i.e. Out of Pocket expenses)
 - and
 - any facility extended to him but does not include any remuneration paid to him for any other service rendered at request of Co.

Note :- Engagement Letter is valid even if it is signed without stating remuneration and it has clause that the fee to be mutually decided

Auditor to sign Audit report etc. [Section 145]

Auditor shall sign

- Auditor's report
- or
- Sign/certify any other doc. of Co.
- in accordance of section 141 (2)
- &

Qualification/observation/comments mentioned in Auditor Report on financial transaction/ Matters which have adverse effect on functioning of Co. shall be read before GM & Shall be open to inspection by any Member of Co.

Note :- Entire audit report is not required to be read in GM

Auditors to attend General Meeting [Section 146]

- (1) Notice or other communication related to any GM shall be forwarded to Auditor
- (2) Unless exempted by Co., Auditor shall attend GM
 - by himself
 - or
 - through Authorised representative (qualified to be auditor)
- (3) Auditor shall have right to be heard on such business which concerns him as auditor.

Punishment for Contravention [Section 147]

- (1) Contravention u/s 139 to 146 (both inclusive)

| Liable | Minimum (in Rs.) | Maximum (in Rs.) |
|--|------------------|------------------|
| Company | 25,000 | 5,00,000 |
| Every officer of the company who is in default | 10,000 | 1,00,000 |

- (2) Contravention by Auditor u/s 139, 144, 145

| Liable | Minimum (in Rs.) | Maximum (in Rs.) |
|---------|------------------|---|
| Auditor | 25,000 | Lower of (i) 5,00,000 or (ii) 4 times the remuneration |

| Liable | Liable for | Minimum | Maximum |
|---------|--|--|---|
| Auditor | Knowing or willful contravenes any of the provisions of section 139, 144 or 145, | Rs. 50,000 | Lower of Rs. 25,00,000 Or 8 times the remuneration |
| | | AND | |
| | | Imprisonment for a term which may extend to 1 year | |

- (3) If auditor is convicted above, the he shall be liable to
 - (a) refund remuneration received by him to Co.
 - (b) pay damages to Co./ Statutory bodies or authorities /members/creditors for loss arising out of incorrect or misleading statements made in his audit report
- (4) In case of audit firm, it is proved that partners or partners of such firm
 - (a) acted in fraudulent manner
 - or

(b) abetted or colluded in any fraud against Co. the liability (Civil or Criminal) as per this Act/other law, for such act shall be of partners concerned of the audit firm and of firm – Jointly & Severally & shall be liable under section 447.

In case of criminal liability, **punishable with only imprisonment – Only concerned partners liable.**

Fraud Reporting [Section 143 (12)]

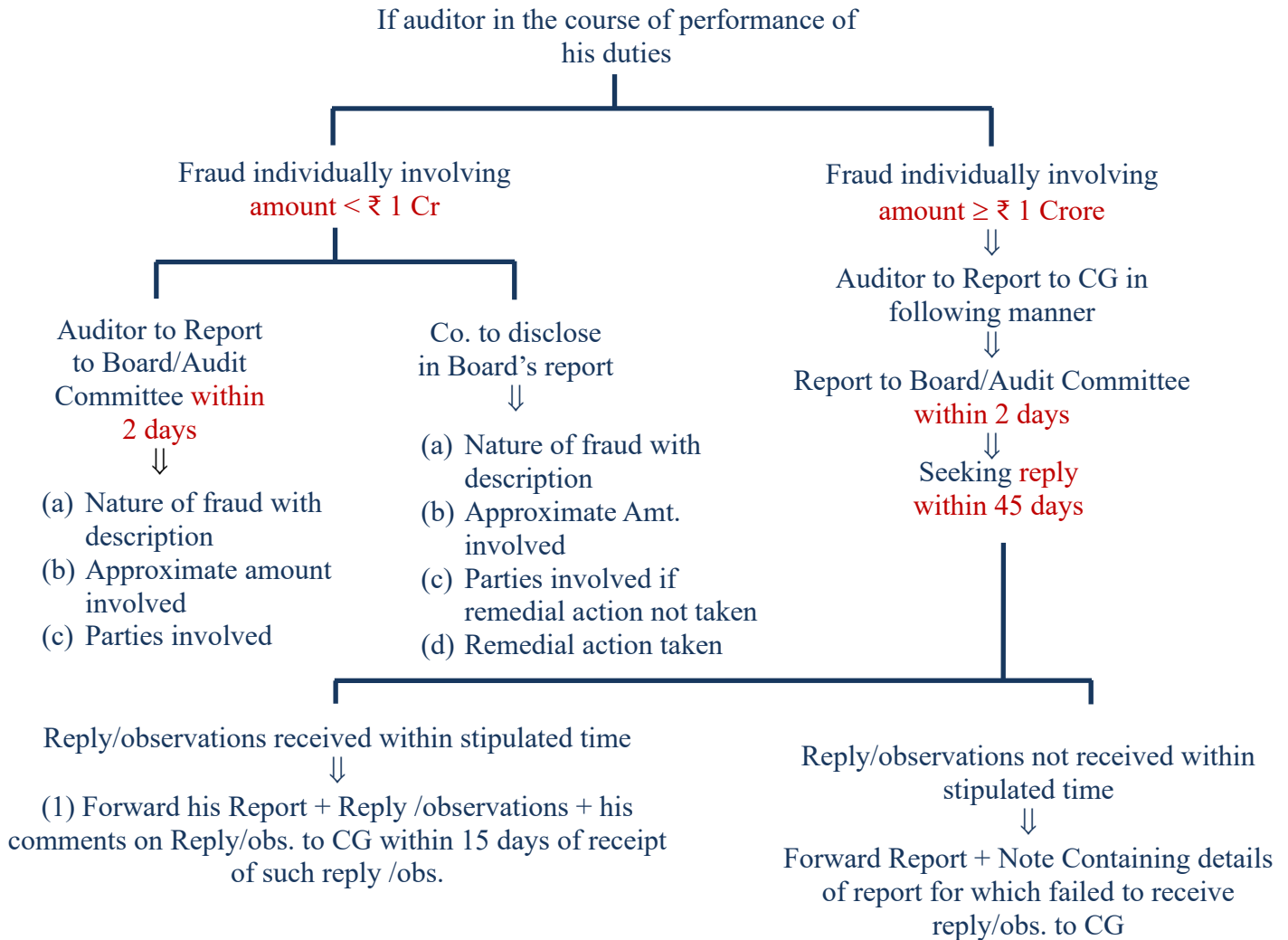

- (1) Report shall be **in ADT-4**
- (2) Report shall sent to **Secretary, MCA** in a sealed cover by RPAD or speed post followed by an **e-mail in confirmation** of the same
- (3) Report shall be **on the letterhead of auditor** containing postal address, e-mail address and contact telephone number or mobile number and be signed by the auditor with his seal and shall indicate his Membership Number

- (4) This section shall mutatis mutandis apply to-
 - (a) Cost Accountant conducting Cost Audit
 - (b) Co. secretary conducting secretarial Audit
- (5) If auditor/Cost Accountant/Co. Secretary in practice do not comply with provisions of section 143 (12), he shall
 - In case of Listed Co. - ₹ 5 Lakh
 - In case of Other Co. – ₹ 1 Lakh

Powers and duties of Auditors [Section 143]

- (1) Power of Auditors: -
 - (a) Right to **access BOA and vouchers** of Co. at all times
 - (b) **Entitle to** require from officers such **information & explanation** as may be necessary for performance of his duties.
 - (c) Right to **access records of all its subsidiary or associate Cos.** in so far it **relates to consolidation.**
- (2) Inquiries by Auditors
 - (a) Whether **loans & advances** have been properly secured
 - (b) Whether **terms of loans & advances** are **prejudicial to** interest of Co./members
 - (c) Whether **loans & advances** by Co. have been shown as deposits
 - (d) Whether **transaction represented merely by book entries** are **prejudicial to interest of Co.**
 - (e) Whether **personal expenses** has been charged to **revenue A/c**
 - (f) In books, if shares have been allotted for cash
 - Whether **cash is actually received**
 - If **no cash received**, whether **BoA & B/S** is correct, regular and not misleading.
 - (g) Where the Co. not being an investment Co. or a banking Co., whether so much of the assets of the company as consist of shares, debentures and other securities have been **sold at a price less than that at which they were purchased by the Co.;**
- (3) Auditor Report :- Auditor shall make **report to members**

| Report on | After taking into A/C | Express opinion |
|---|---|--|
| (1) A/Cs examined (2) Every FS laid before Co. in GM | <input type="checkbox"/> Provision of Act <input type="checkbox"/> AS and SAs <input type="checkbox"/> Matters to be included in Auditor's Report | ⇒ To the best of his information & knowledge ⇒ A/Cs & FS give True & Fair view of state of Cos. |

- (4) Matters to be stated in AUDITOR REPORT - Whether
- A – Any Qualification/Reservation/adverse remark relating to maintenance of A/Cs and other matters connected therewith
 - U – Unpaid Dividend or other amount not transfer to IEPF within time limit prescribed by law
 - D – Director is disqualified from being appointed as Director u/s 164 (2)
 - I – Internal Financial controls with reference to financial statements are adequate & in place & operating effectiveness of such controls
 - T – The Financial statement comply with AS
 - O – Observations or comments of auditors on financial transaction or matters which have any adverse effect on the functioning of Co.
 - R – Reserves or provisions required under any law or accounting standard has made for foreseeable losses, if any, on long term contracts including derivative contracts
 - R – Reports on the accounts of any branch office audited by person other than company’s auditor, has been sent to him and the manner in which he has dealt with it preparing his audit report
 - E – Extra (Other) Matters as may be prescribed
 - P – Proper BoA as per law has been kept by Co. in auditor’s opinion so far as appears from his examination of those books and proper returns adequate for audit have been received from branches not visited by him
 - O – Obtained all the info and explanations which to the best of his knowledge and belief were necessary for the purpose of the audit and if not, the details thereof & effect of such information on the financial statements
 - R – Regardless BS & P&L are in agreement with BoA & Return
 - T – Trail feature in the accounting software used by the Co. & the same has been operated throughout the year for all transactions recorded in the software & audit trail feature has not been tampered with & the audit trail has been preserved by the Co. as per statutory requirement
- (5) Where any matter included in audit report is answered in negative or with a qualification, the report shall state the reasons thereof
- (6) Audit of Govt. Co./Govt. Controlled Co.
- (a) **C&AG to appoint auditor** of Govt. Co. or Govt. Controlled Co. **and direct the manner in which A/Cs are to be audited** & Auditor to submit copy of Audit report to C&AG which will include
 - Directions issued by C&AG
 - Action taken thereon
 - Impact on accounts & FS of Co.
 - (b) Supplementary Audit

Within 60 days of receipt of audit report, C&AG shall have right to

 - **Conduct supplementary audit** of FS by person as he may authorise in this behalf.
 - Comment upon or supplement such audit report. Any such **comment by C&AG shall be sent by Co. to every person entitled to FS** u/s 136 & placed before AGM along with audit report.
 - (c) Test Audit

If C&AG consider necessary, **C&AG may by order cause test audit** to be conducted of BoA of Govt. Co./Govt. Controlled Co.

(7) Branch Audit

(a)

| Branch in India | Branch Outside India |
|---|--|
| Audit by - Co's auditor appointed u/s 139 or - Any other person qualified for auditor & appt. as such for branch audit | Audit by - Co's Auditor or - Accountant or any other person duly qualified to act as auditor as per law of that country |

(b) Duties and power of Co.'s Auditor w.r.t. branch audit shall be as per Section 143(1) to 143(4)

(c) Branch auditor to prepare report on BoA of branch & send it to Co'.s Auditor

(d) Co.'s auditor shall deal with such report in his report in manner as he consider necessary

(e) Provisions regarding reporting of fraud by the auditor shall also extend to such branch auditor to the extent it relates to the concerned branch.

(8) Every auditor shall comply with auditing standard prescribed by CG in consultation with NFRA.

(9) For prescribed Co., auditor also need to do reporting of CARO.

Cost Records & Cost Audit [Section 148]

(1) Cost Records

- Co including foreign Co. engaged in production of specified goods or providing specified services (Regulated /Non-regulated), whose OVERALL Turnover is \geq Rs. 35 Crores shall maintain cost records
- Not applicable to Micro or small Enterprise

(2) Cost Audit

| Preceding FY | Regulated Sector | Non-Regulated Sector |
|--|-------------------------|-----------------------------|
| Overall Turnover | \geq Rs. 50 Crores | \geq Rs. 100 Crores |
| | AND | AND |
| Aggregate Turnover of Specified goods & Services | \geq Rs. 25 Crores | \geq Rs. 35 Crores |

Cost audit not applies to Co. :-

- Whose forex revenue from exports 75% of total revenue or
- Which is operating in SEZ or
- Which is generating electricity for captive consumption

(3) Appointment and Remuneration of Cost Auditor

| Co. required to constitute Audit Committee | Co. not required to constitute Audit Committee |
|---|--|
| (1) On recommendation of Audit Committee, BoD to appoint Cost Accountant in practice or firm of Cost Accountant in practice. (2) Remuneration recommended by Audit committee considered & approved by BoD & ratified by Shareholders | (1) BoD to appoint Cost Accountant in practice or firm of Cost Accountant in practice. (2) Remuneration considered and approved by BoD and ratified by shareholder subsequently |

- (4) Cost Auditor shall comply with cost Auditing standards issued by Institute of Cost Accountant of India.
- (5) Cost Audit is in addition to statutory Audit.
- (6) Qualification, disqualification, rights, duties and obligations applicable to auditors under this chapter shall as for as applicable apply to cost Auditor.
- (7) Cost Auditor to **submit his cost audit report to BoD of Co.**
- (8) **Within 30 days of receipt of Cost Audit report, Co. shall furnish CG with Cost Audit Report + Full information & Explanation on every reservation or qualification contained therein**
- (9) On receipt, if CG is of the opinion that further information & explanation is required it may call for such information & explanation & Co. shall furnish the same within time specified by CG
- (10) **Statutory auditor can't be appointed as cost auditor**
- (11) BoD. Shall **appoint a cost auditor within 180 days** of the commencement of every FY
- (12) Co. shall inform the cost auditor of appointment and **shall file CRA-2 with CG within 30 days of the Board meeting** in which such appointment is made **or within 180 days of the commencement of the FY, whichever is earlier**
- (13) Tenure – Cost auditor shall **continue till the expiry of 180 days** from the closure of the financial year **or till he submits the cost audit report**, whichever is earlier
- (14) **Cost Auditor can be removed through board resolution** after giving reasonable OOBH & **intimate to CG in form CRA-2**
- (15) Fill casual vacancy within 30 days by Board & inform CG in form CRA-2 within 30 days of appointment
- (16) Default under this section
 Co. & OID – Punishment u/s 147(1)
 Cost Auditor – Punishable u/s 147 (2) & (4)
- (17)

| Form | Purpose |
|-------------|--|
| CRA-1 | The manner in which cost records to be maintained |
| CRA-2 | For intimation of appointment of cost auditor by company to the Central Government |
| CRA-3 | Cost Audit Report |
| CRA-4 | Filing of the cost audit report with the Central Government |

COMPANIES INCORPORATED OUTSIDE INDIA

Foreign Co. [Section 2(42)]

“Foreign Co.” means any Co. or body corporate incorporated outside India which-

- a. has a PoB in India whether by itself or through an agent, physically or through electronic mode; and
- b. conducts any business activity in India in any other manner.

“Electronic mode” means carrying out electronically based, whether main server is installed in India or not, including, but not limited to –

- a. Business to business and business to consumer transactions, data interchange and other digital supply transactions;
- b. Offering to accept deposits or inviting deposits or accepting deposits or subscriptions in securities, in India or from citizens of India;
- c. Financial settlements, web-based marketing, advisory and transactional services, database services and products, supply chain management;
- d. Online services such as telemarketing, telecommuting, telemedicine, education and information research; and
- e. All related data communication services, whether conducted by e-mail, mobile devices, social media, cloud computing, document management, voice or data transmission or otherwise.

Note :- Electronic mode excludes electronic based offering of securities in IFSC

Application of Act to Foreign Companies (Section 379)

- i. Sections 380 to 386 (both inclusive), sections 392 and 393 shall apply to all foreign companies
- ii. Minimum 50% of paid-up share capital, whether equity or preference or partly equity and partly preference, of a foreign Co. incorporated outside India is held by:
 - i. one or more citizens of India; or
 - ii. by one or more companies or bodies corporate incorporated in India; or
 - iii. by one or more citizens of India and one or more companies or bodies corporate incorporated in India,
- iii. whether singly or in aggregate, such foreign Co. shall also comply with provisions of Chapter XXII and such other provisions of this Act as may be prescribed with regard to its Indian business as if it were a Co. incorporated in India.

Documents, Etc., To be Delivered to RoC By Foreign Companies (Section 380)

- i. Every foreign Co. shall deliver in Form FC-1 to RoC for registration within 30 days of establishment of its PoB in India :
 - a. a certified copy of charter, statutes or memorandum and articles defining constitution of Co. If instrument is not in English language, a certified translation thereof in English language;

- b. the full address of registered or principal office of Co.;
- c. a list of directors and secretary of Co. containing such particulars as may be prescribed; (refer Note)
- d. the name and address of one or more persons resident in India authorised to accept on behalf of Co. service of process and any notices or other documents required to be served on Co.;
- e. the full address of office of Co. in India which is deemed to be its principal PoB in India;
- f. particulars of opening and closing of a PoB in India on earlier occasion or occasions;
- g. declaration that none of directors of Co. or authorised representative in India has ever been convicted or debarred from formation of companies and management in India or abroad;
- h. any other information as may be prescribed.

Application shall be supported with an attested copy of approval from RBI under FEMA or Regulations, and from other regulators, if any, approval is required or a declaration from authorised representative of such foreign Co. that no such approval is required.

Foreign Co. shall file particulars of alteration with RoC in form FC-2 along with prescribed fees within 30 days of alteration.

Note - The list of directors and secretary or equivalent of foreign Co. shall contain following particulars, for each of persons included in such list, namely:

- 1) Name and surname in full;
- 2) any former name or names and surname or surnames in full;
- 3) father's name or mother's name or spouse's name;
- 4) date of birth;
- 5) residential address;
- 6) nationality;
- 7) if present nationality is not nationality of origin, his nationality of origin;
- 8) passport number, date of issue and country of issue; (if a person holds more than one passport then details of all passports to be given)
- 9) income-tax PAN, if applicable;
- 10) occupation, if any;
- 11) whether directorship in any other Indian Co., DIN, Name and CIN of Co. in case of holding directorship;
- 12) other directorship or directorships held by him;
- 13) Membership Number of Secretary only; and
- 14) e-mail ID.

Accounts of Foreign Co. [Section 381]

- 1) Unless exempted by CG, every foreign Co. shall
 - a) Prepare Balance sheet & Profit and Loss Account for every FY as per Schedule III along with prescribed documents
 - Documents required to be annexed as per Chapter of Accounts of Companies
 - Statement relating to CFS of the parent foreign Co.
 - Statement of related party transactions

- Statement of repatriation of profits
 - Statement of transfer of funds (including dividends, if any)
 - List of all PoB in India as on the date of balance sheet
- b) Deliver to RoC copy of above-mentioned documents in Form FC-3
- Within 6 Months of Close of FY
 - Extension upto 3 months by RoC on application by Foreign Co.
- 2) Audit of Accounts of Foreign Co. –
- Every foreign Co. shall get its accounts pertaining to Indian business operations audited by a practicing CA in India or firm or LLP of practicing CAs.
 - The provisions of Chapter X i.e. Audit and Auditors and rules made there under shall apply, mutatis mutandis, to foreign Co.

Display of Name, Etc., Of Foreign Co. [Section 382]

| | |
|---|--|
| Foreign Co. has duty to conspicuously exhibit following | - Name of Foreign Co. - Name of Country of Incorporation - liability of members is limited |
| Location | Outside every office/PoB in India |
| Language | Legible characters in English Legible characters in Local language |

| | |
|---------------------------|--|
| Foreign Co. shall mention | - Name of Foreign Co. - Name of Country of Incorporation - liability of members is limited |
| Location | - Business letters - Bills heads - Letter papers - Notices - Official Communications |
| Language | Legible characters in English language |

Service on Foreign Co. [Section 383]

- Any notice or document required to be served on a foreign Co. shall be deemed to be served,
- if addressed to any person whose name and address have been delivered to RoC under section 380 and
- left at, or sent by post to, address which has been so delivered to RoC or by electronic mode.

Debentures, Annual Return, Registration of Charges, Books of Account and Their Inspection [Section 384]

| | |
|--|--|
| Section 71 – Debentures | Apply Mutatis Mutandis to Foreign Co. |
| Section 92 – Annual Return | Applicable to Foreign Co. file annual return in Form FC-4 within 60 days from last day of its FY |
| Section 135 – CSR | Applicable to Foreign Co. |
| Section 128 – Books of Accounts | Applicable to Foreign Co., subject to modifications:- -BoA kept at principal PoB in India - BoA kept with respect to monies received and spent, sales and purchase made, and assets and liabilities, in course of or in relation to its business in India. |
| Section 77 to 87 – Registration of Charges | Apply Mutatis Mutandis to Foreign Co. |
| Section 206 to 229 – Inspection, Inquiry & investigation | Apply Mutatis Mutandis to Foreign Co. |

Fee For Registration of Documents [Section 385]

There shall be paid to RoC for registering any document required by provisions of this Chapter to be registered by him, such fee, as may be prescribed.

Interpretation [Section 386]

For purposes of foregoing provisions of this Chapter, expression:

- a. “Certified” means certified in prescribed manner to be a true copy or a correct translation;
- b. “Director”, in relation to a foreign Co., includes any person in accordance with whose directions or instructions Board of Directors of Co. is accustomed to act; and
- c. “Place of business” includes a share transfer or registration office.

Dating of Prospectus and Particulars to Be Contained Therein [Section 387]

No person shall issue any prospectus in India offering to subscribe for securities of a Co. incorporated outside India unless—

- a. states matters specified u/s 26 (Matters to be stated in prospectus).
- b. contains following particulars :—
 - 1) instrument defining constitution of Co.;
 - 2) provisions under which incorporation of Co. was effected;
 - 3) address in India where instrument, enactments or provisions, or copies thereof can be inspected;
 - 4) date of incorporation;
 - 5) name of country in which Co. was incorporated and
 - 6) whether Co. has established PoB in India and, if so, address of its principal office in India; and

Provided that points (1), (2) and (3) shall not apply in case of a prospectus issued more than 2 years after date at which Co. is entitled to commence business.

Any condition binding applicant to waive compliance with any requirement of section 387(1) shall be void.

No person shall issue application form to any person in India unless form is issued with a prospectus provided that this shall not apply in connection with underwriting agreement

Provisions as to Expert's Consent and Allotment [Section 388]

- i. No person shall issue in India any prospectus of a Co. incorporated outside India
 - a. Containing expert statement if
 - He has not given his written consent
 - He has withdrawn his written consent before delivery of prospectus for registration
 - b. If prospectus does not have effect of rendering all persons bound by section 33 and section 40

Note – for purpose of this section, statement shall be deemed to be included in a prospectus, if it is contained in any report or memorandum appearing on face thereof or by reference incorporated therein.

Registration of Prospectus [Section 389]

No person shall issue, circulate or distribute in India any prospectus of a Co. incorporated outside India, whether Co. has or has not established a PoB in India, unless before issue of prospectus in India;

- ✓ a copy of prospectus certified by chairperson of Co. and two other directors has been delivered for registration to RoC; and
- ✓ the prospectus states on face of it that a copy has been so delivered, and
- ✓ there is attached to copy, expert consent to issue of prospectus and
- ✓ such documents as may be prescribed.

According to Companies (Registration of Foreign Companies) Rules, 2014, following documents shall be attached to prospectus:

- a. consent of expert to issue of prospectus;
- b. a copy of contracts for appointment of managing director or manager and in case of a contract not reduced into writing, a memorandum giving full particulars thereof;
- c. a copy of any other material contracts entered within preceding 2 years not in ordinary course of business
- d. a copy of underwriting agreement; and
- e. a copy of power of attorney, if prospectus is signed through duly authorized agent of directors.

Offer of Indian Depository Receipts [Section 390]

CG may make rules applicable for—

- i. the offer of Indian Depository Receipts (IDR);
- ii. the requirement of disclosures in prospectus or letter of offer issued in connection with IDR;
- iii. the manner in which IDR shall be dealt with in a depository mode and by custodian and underwriters; and
- iv. the manner of sale, transfer or transmission of IDR, by a Co. incorporated outside India, whether Co. has or has not established any PoB in India.

Application of Sections 34 to 36 and Chapter XX [Section 391]

Provisions of sections 34 to 36 (both inclusive) shall apply to—

- i. the issue of a prospectus by a Co. incorporated outside India under section 389;
- ii. the issue of IDR by a foreign Co.

Provisions of Chapter XX (i.e. Chapter on Winding up) shall apply mutatis mutandis for closure of PoB of a foreign Co. in India as if it were a Co. incorporated in India in case such foreign Co. has raised monies through offer or issue of securities under this Chapter which have not been repaid or redeemed.

Merger of Foreign Co. [Section 234]

- Provisions of Chapter XV shall apply mutatis mutandis to schemes or mergers and amalgamations between companies registered under this Act and companies incorporated in jurisdictions of such countries as may be notified from time to time by CG.
- A foreign Co., may with prior approval of RBI, merge into a Co. registered under this Act or vice versa and terms and conditions of merger may provide for payment of consideration to shareholders of merging Co. in cash, or in Depository Receipts, or partly in cash and partly in Depository Receipts
- Here “foreign Co.” means any Co. or body corporate incorporated outside India whether having a PoB in India or not.

Punishment for contravention [Section 392]

Punishment for contravention of this chapter by Foreign Co. :

1. Fine on foreign Co. in range of 1 lac rupees to 3 lac rupees.
2. In case of continuing default an additional fine on foreign Co. to tune of 50,000 rupees /day after first during which contravention continues.
3. Punishment for every officer in default shall be fine of a minimum amount of 25,000 rupees, but which may extend to 5 lac rupees.

Co.'s Failure to Comply with Provisions of this Chapter Not to Affect Validity of Contracts, Etc. [Section 393]

- Any failure by a Co. to comply with provisions this chapter
- shall not affect validity of any contract, dealing or transaction entered into by Co. or its liability to be sued
- However, Co. not be entitled to bring any suit/ claim any set-off/ make any counter-claim / start any legal proceeding any such contract until Co. has complied with provisions of this Act

Action for Improper Use or Description as Foreign Co.:

If any person or persons trade or carry on business under any name or title or description as a foreign Co. registered under Act or rules made thereunder, that person or each of those persons shall, unless duly registered as foreign Co. under Act and rules made thereunder, shall be liable for investigation under section 210 of Act and action consequent upon that investigation shall be taken against that person.

Exemptions Under This Chapter

The CG may, by notification, exempt any class of-

- a. foreign companies;
- b. companies incorporated outside India, whether Co. has or has not established a PoB in India,

in so far as they relate to offering for subscription in securities, requirements related to prospectus, and all matters incidental thereto in IFSC

THE LIMITED LIABILITY PARTNERSHIP ACT, 2008

Short Title, Extent and Commencement [Section 1]

- Short Title - Limited Liability Partnership Act, 2008
- Extent - Whole of India
- Commencement - Different Provisions may be notified on different dates by CG

Characteristics of LLP

| | | | |
|-----------------------|-------------------------------|--------------------------|---------------------------|
| Body Corporate | Artificial Legal Person | Minimum -2 Partners | CG can Investigate |
| Perpetual Succession | Common Seal (Optional) | Maximum - No Limit | Compromise or Arrangement |
| Separate legal entity | Limited liability of partners | Business for profit only | Conversion into LLP |
| LLP Agreement | Management of business | CG can Investigate | E-filing of documents |

Important Definitions

Body Corporate [(Section 2(1)(d))]: It means a company as defined in Companies Act, 2013 and includes—

- a LLP registered under this Act;
- a LLP incorporated outside India; and
- a company incorporated outside India,

but does not include—

- a corporation sole;
- a co-operative society
- any other body corporate (not being a company under Companies Act, 2013 or a LLP as defined in this Act), which the CG may specify

Financial Year [Section 2(1)(l)]: “Financial year”, in relation to a LLP, means the period from the 1st April of a year to the 31st March of the following year.

However, in the case of a LLP incorporated after 30th September of a year, the financial year may end on the 31st March of the year next following that year.

Foreign LLP [section 2(1)(m)]: It means a LLP formed, incorporated or registered outside India which establishes a place of business within India.

Limited Liability Partnership (LLP) [Section 2(1)(n)]: LLP means a partnership formed and registered under this Act.

LLP agreement [Section 2(1)(o)]:

- It means any written agreement
- between the partners of LLP or
- between LLP and its partners
- which determines the mutual rights and duties of the partners and
- their rights and duties in relation to that LLP.

Small LLP [Section 2(1)(ta)]: It means a LLP with

| | |
|--|-------------------|
| Contribution | Up to ₹ 25Lakhs & |
| Turnover for immediately preceding F.Y | Up to ₹ 40 Lakhs |

Partners [Section 5]

Any individual or body corporate may be a partner in a LLP.

However, an individual shall not be capable of becoming a partner of a LLP, if—

- a. he is of **unsound mind** or
- b. he is an **undischarged insolvent**; or
- c. he has **applied to be adjudicated as insolvent** and his application is pending.

Minimum number of Partners [Section 6]

- i. Every LLP shall have **at least 2 partners**.
- ii. If at any time **no. of partners is reduced below 2** and LLP carries on business for more than 6 months, **only partner who has the knowledge** of the fact that LLP is carrying on business **shall be liable personally** for the obligations of LLP

Designated Partners [Section 7]

1. Every LLP shall have **at least 2 designated partners** who are individuals and **at least 1 of them shall be a resident in India**.
2. If all the partners are bodies corporate or in which one or more partners are individuals and bodies corporate, **at least 2 individuals who are partners of such LLP or nominees of such bodies corporate** shall act as designated partners.
3. Resident in India means a person who has stayed in India for a period of **not less than 120 days during the financial year**.
4. **Prior written consent** from Designated partner
5. LLP shall **intimate registrar within 30 days** about appointment of designated partner

6. Every designated partner of LLP shall obtain a Designated Partner Identification Number (DPIN)
7. If the incorporation document
 - a. specifies who are to be designated partners, such persons shall be designated partners on incorporation; or
 - b. states every partner shall be a designated partner;
 - ii. any partner may become a designated partner by and in accordance with LLP Agreement and a partner may cease to be a designated partners in accordance with LLP agreement.

Liabilities of Designated Partners [Section 8]

Designated partner shall be—

- a. responsible for the doing of all acts to be done by LLP in respect of compliance of this Act including filing of any document, return, statement etc. and
- b. liable to all penalties imposed on LLP for any contravention of those provisions.

Changes in Designated Partners [Section 9]

A LLP may appoint designated partner within 30 days of vacancy and intimate registrar within 30 days of appointment
if no designated partner is appointed, or if at any time there is only one designated partner, each partner shall be deemed to be a designated partner.

Punishment for contravention of sections 7 and 9 [Section 10]

| Contravention | Liable | Penalty | Continuing contravention |
|--|------------------------------------|------------|--|
| LLP to have at least 2 designated partners who are individuals & at least 1 of them is resident in India | LLP & its every partner | Rs. 10,000 | Rs.100 per day subject to maximum Rs. 1 lakhs for LLP and Rs.50,000 for every partner. |
| Non-filing of particulars of designated partner with registrar | LLP & its every designated partner | Rs. 5,000 | Rs.100 per day subject to maximum of Rs.50,000 for LLP and Rs.25,000 for every designated partner |
| Where the designated partner is disqualified | LLP & its every partner | Rs. 10,000 | Rs.100 per day subject to maximum Rs.1,00,000 for LLP and Rs.50,000 for every partner of such LLP. |
| Where there is vacancy in office of designated partner and not filled within time | LLP & its every partner | Rs. 10,000 | Rs.100 per day subject to maximum Rs.1,00,000 for LLP and Rs.50,000 for every partner of such LLP. |

Incorporation Document [Section 11]

Document needed for registration is the incorporation document.

1. For a LLP to be incorporated:
 - (a) **2 or more persons** associated for carrying on a lawful business with a view to earn profit **shall subscribe their names to incorporation document;**
 - (b) the incorporation document shall be **filed with the Registrar** of the State in which the registered office of LLP is to be situated and
 - (c) **Statement by advocate/CS/ CA /Cost Accountant**, who is engaged in formation of LLP **and by any one subscriber**
 - that all the requirements of this Act and the rules made thereunder have been complied with,
 - in respect of incorporation and matters precedent and incidental thereto.
2. The incorporation document shall—
 - a. be in a form as may be prescribed;
 - b. state the **name of LLP;**
 - c. state the **proposed business** of LLP;
 - d. state the address of the **registered office** of LLP;
 - e. state the **name and address of each** of the persons who are to be **partners** of LLP on incorporation;
 - f. state the name and address of the persons who are to be **designated partners** of LLP on incorporation;
 - g. contain such **other information** concerning the proposed LLP as may be prescribed.
3. If a person **makes a statement** as discussed above which he—
 - a. **knows to be false;** or
 - b. does not believe to be true,
shall be punishable (Penalty for false declaration)
 - with imprisonment for a term which may extend to 2 years and
 - with fine which shall not be less than Rs.10,000 but which may extend to Rs.5 Lakhs.

Incorporation by Registration [Section 12]

1. **Registrar shall register** the incorporation document **within 14 days** and give a certificate that LLP is incorporated by the name specified therein.
2. The certificate shall be **conclusive evidence** that LLP is incorporated by the name specified therein.

Registered Office of LLP and Change therein [Section 13]

1. Every LLP shall have a registered office to which all communications and notices may be addressed and where they shall be received.
2. A document may be served on LLP /partner/ designated partner by sending it by post or by registered post or any other manner as may be prescribed, at the registered office and other address specifically declared by LLP
3. A LLP may change the place of its registered office and file the notice of such change with the Registrar in manner as may be prescribed
4. If LLP contravenes any provisions of this section, LLP and its every partner shall be punishable with penalty of Rs. 500 per day subject to maximum Rs. 50,000.

Effect of registration [Section 14]

On Registration, LLP by its name, shall be capable of -

- i. Suing and being sued;
- ii. Acquiring, owning, holding /developing / disposing of property
- iii. Having a common seal, if it decides to have one; and
- iv. Doing and suffering other acts and things as bodies corporate may lawfully do and suffer.

Name [Section 15]

1. Every LLP shall have either the words “Limited Liability Partnership” or the acronym “LLP” as the last words of its name.
2. In the opinion of the CG, name shall not be—
 - a. undesirable; or
 - b. identical or too nearly resembles to other LLP or a company or a registered trademark

Reservation of name [Section 16]

1. A person may apply to Registrar for the reservation of a name set out in the application as—
 - a. the name of a proposed LLP; or
 - b. the name to which a LLP proposes to change its name.
2. Upon receipt of application and on payment of the fee, Registrar reserve the name for a period of 3 months from the date of intimation by the Registrar.

Rectification of name of LLP [Section 17]

1. If LLP is registered by a name which is identical with or too nearly resembles to-
 - a. that of **any other LLP or a company**; or a **registered trade mark**
 - b. then on application of such LLP or proprietor or company,
CG may direct LLP to change its name within 3 months

Note:- **Application of the proprietor** of the registered trade marks shall be maintainable **within a period of 3 years**
2. Within 15 days of name change, **LLP shall give notice to Registrar along with the order of the CG, & registrar shall issue fresh certificate of incorporation** and within 30 days of change in the certificate of incorporation, LLP shall change its name in LLP agreement.
3. If **LLP fails to change name within 3 months**, **CG shall allot a new name** to LLP and the Registrar shall enter new name in the register of LLP and issue a fresh certificate of incorporation with new name.

Eligibility to be partners [Section 22]

- On incorporation of LLP, persons who subscribed their names to the incorporation document shall be its partners
- Any other person may become a partner of LLP by and in accordance with LLP agreement.

Relationship of partners [Section 23]

1. **Mutual rights and duties of the partners** of a LLP, and the mutual rights and duties of a LLP and its partners, **shall be governed by LLP agreement**
2. **LLP agreement** and any changes shall be **filed with the Registrar within 30 days**
3. Any written pre-incorporation agreement between the subscribers to incorporation document may impose obligations on LLP, provided such agreement is ratified by all the partners after incorporation of LLP.
4. In the absence of agreement, mutual rights are determined by the **First Schedule**.

Cessation of partnership interest [Section 24]

1. A person may cease to be a partner of a LLP in accordance with an agreement with the other partners or,
2. In the absence of agreement, **by giving a notice in writing of not less than 30 days** to the other partners of his intention to resign as partner.

3. A person shall cease to be a partner of a LLP—
 - a. on his **death** or dissolution of LLP; or
 - b. if he is declared to be of **unsound mind** by a competent court; or
 - c. if he has applied to be **insolvent** or declared as an insolvent.
4. Former partner is to be regarded as partner of LLP unless—
 - a. the person has notice that the former partner has ceased to be a partner of LLP; or
 - b. notice that the former partner has ceased to be a partner of LLP has been delivered to the Registrar.
5. The cessation of a partner from LLP does not by itself discharge the partner from any obligation to LLP or to the other partners or to any other person which he incurred while being a partner.
6. Unless otherwise provided in LLP agreement, former partner or a person entitled to his share in consequence of the death or insolvency of the former partner, shall be entitled to receive from LLP—
 - a. an amount equal to the capital contribution of the former partner actually made to LLP; and
 - b. his right to share in the accumulated profits of LLP, after the deduction of accumulated losses of LLP, determined as at the date the former partner ceased to be a partner.
7. A former partner or a person entitled to his share shall not have any right to interfere in the management of LLP.

Registration of changes in partners [Section 25]

| | | |
|---------------------------------------|--|--|
| Intimation by Partner to LLP | Inform LLP of change in name or address of partner in 15 days | Penalty for partner – Rs. 10,000 |
| Notice by LLP to Registrar | File notice with registrar within 30 days - Admission of partner (with consent) - Cessation of Partner - Change in name or address of partner | Penalty for every designated partner – Rs. 10,000 |
| Notice by former partner to Registrar | <ul style="list-style-type: none"> • Any partner who ceases to be partner • Can file notice with registrar • If he has reasonable believe • LLP may not file notice with registrar | Registrar shall obtain confirmation from LLP If no confirmation is given by LLP within 15 days, Registrar shall register the notice given by former partner |

Partner as agent [Section 26]

For the purpose of business of LLP, every partner of a LLP is the agent of LLP, but not of other partners of LLP.

Extent of Liability of LLP [Section 27]

1. A LLP is not liable if—
 - a. the **partner in fact has no authority** to act for LLP in doing a particular act; and
 - b. the **person knows that he has no authority** or does not know or believe him to be a partner of LLP.
2. LLP is liable if
 - a. a partner of a LLP is liable to any person as a result of a wrongful act or omission on his part in the course of the business of LLP or
 - b. with its authority.
3. **Obligation of LLP shall be solely the obligation of LLP** and shall be met out of property of LLP.

Extent of liability of partner [Section 28]

1. A **partner is not personally liable** for obligation of LLP.
2. This section shall not affect personal liability of a partner for his own wrongful act or omission
3. But a **partner shall not be personally liable for wrongful act or omission of any other partner** of LLP.

Holding out [Section 29]

1. Any person,
 - who by words spoken or written or by conduct,
 - represents himself, or knowingly permits himself to be represented to be a partner in a LLP
 - is liable to any person
 - who has on the faith of any such representation
 - given credit to LLP, whether the person representing himself or represented to be a partner does or does not know that the representation has reached the person so giving credit.

However,

- where any credit is received by LLP as a result of such representation,
- LLP shall,
- without prejudice to the liability of the person so representing himself or represented to be a partner,
- be liable to the extent of credit received by it or any financial benefit derived thereon.

- Where after a partner's death the business is continued in the same LLP name, the continued use of that name or of the deceased partner's name as a part thereof shall not by itself make his legal representative or his estate liable for any act of LLP done after his death.

Unlimited liability in case of fraud [Section 30]

- In the event of an act carried out by a LLP, or any of its partners,
 - with intent to defraud creditors of LLP or any other person, or for any fraudulent purpose,
 - their **Liability shall be unlimited**
 - But in case any such act is carried out by a partner
 - LLP is Liable to the same extent as partner
 - Unless it is established by LLP that such act was without the knowledge /authority of LLP
- Where any business is carried on with fraudulent intent then
 - every person who was knowingly a party fraud shall be punishable with
 - imprisonment upto 5 years and
 - with fine = Rs. 50,000 to Rs. 5 Lakhs.
- Where a LLP or any partner or designated partner or employee of such LLP has conducted the affairs of LLP in a fraudulent manner, they shall be liable to pay compensation to the person who suffered loss

Whistle blowing [Section 31]

- Court or Tribunal may reduce or waive any penalty** of partner or employee of LLP, if it is satisfied that—
 - He has provided useful information during investigation of such LLP; or
 - when any information given by him leads to LLP or any partner or employee of such LLP being convicted
- No partner or employee may be discharged, demoted, suspended, threatened, harassed or in any other manner discriminated merely because of providing information

Form of contribution [Section 32]

- A contribution of a partner may consist of
 - tangible, movable or immovable or intangible **property** or
 - other **benefit** to LLP,
 - including **money, promissory notes**, other agreements to contribute cash or property, and
 - contracts for services** performed or to be performed.
- The **monetary value of contribution of each partner** shall be accounted for and disclosed in the accounts of LLP

Obligation to contribute [Section 33]

- The obligation of a partner to contribute money or other property or other benefit or to perform services for a LLP shall be as per LLP agreement.
- A creditor of a LLP, which extends credit or otherwise acts in reliance on an obligation described in that agreement, without notice of any compromise between partners, may enforce the original obligation against such partner.

Books of account [Section 34]

1. Proper Books of account:
 - LLP shall maintain such proper books of account as may be prescribed relating to its affairs for each year of its existence
 - on cash basis or accrual basis and
 - according to double entry system of accounting and
 - shall maintain the same at its registered office
 - for 8 years
2. Statement of Account and Solvency:
 - Every LLP shall,
 - within a period of 6 months from the end of each financial year,
 - prepare a Statement of Account and Solvency
 - for the said financial year as at the last day of the said financial year
 - Signed by designated partners of LLP
3. Every LLP shall file Statement of Account and Solvency with the Registrar every year within 30 days from the end of 6 months of FY
4. The accounts of LLP shall be audited. However, the CG may exempt any class or classes of LLP from the requirements of this sub-section.
5. Penalty for non-compliance of provisions of sub-section 3- LLP – Rs.100 per day subject to maximum Rs.1,00,000 Every Designated Partners - Rs.100 per day subject to maximum Rs.50,000.
6. Penalty for non-compliance of provisions of sub-section 1, 2 & 4 - LLP – not less than Rs.25,000 which may extend to 5 Lakhs. Every designated partner –not less than Rs.10,000 which may extend to Rs.1 Lakh.

Accounting and auditing standards [Section 34A]

CG may, in consultation with NFRA—

- a. Prescribe the standards of accounting; and
- b. Prescribe the standards of auditing, as recommended by ICAI.

Annual Return [Section 35]

1. Every LLP shall file an annual return with the Registrar within 60 days of closure of its financial year.
2. Penalty for non-filing of annual return –
 - LLP – Rs.100 per day subject to maximum Rs.1,00,000
 - Every Designated Partners - Rs.100 per day subject to maximum Rs.50,000

Inspection of Documents Kept by Registrar [Section 36]

The incorporation document, name of partners and changes, if any, made therein, Statement of Account and Solvency and annual return filed by each LLP with the Registrar shall be available for inspection by any person on payment of such fee as may be prescribed.

Penalty for False Statement [Section 37]

If in any return, statement or other document, any person makes a statement—

- a. which is false in any material particular, knowing it to be false; or
 - b. which omits any material fact knowing it to be material,
- he shall be punishable with imprisonment up to 2 years, and fine = 1 lakh to 5 Lakhs

Power of Registrar to Obtain Information [Section 38]

1. In order to obtain such information as the Registrar may consider necessary
 - for the purposes of carrying out the provisions of this Act,
 - the Registrar may require any person including any present or former partner or designated partner or employee of a LLP
 - to answer any question or make any declaration or supply any details or particulars in writing to him within a reasonable period.
2. In case any person does not answer or make declaration or supply details asked or when Registrar is not satisfied with reply or declaration or details or particulars provided, Registrar shall have power to summon that person to appear before him or an inspector or any other public officer whom the Registrar may designate.
3. Without lawful excuse, if any person fails to comply with any summons or requisition shall be punishable with fine = Rs. 2000 to Rs 25000.

Compounding of Offences [Section 39]

1. Offences which are punishable with fine only can be compounded by Regional Director or officer authorized by CG
2. No compounding can be done if the same offence is repeated within 3 years
3. Application for compounding is made to registrar who forwards it to regional director along with his comments
4. Once application of compounding is approved, intimation is given within 7 days
5. Where any offence is compounded before institution of any prosecution, no prosecution shall be instituted
6. Where the compounding of any offence is made after the institution of any prosecution, such compounding shall be brought to notice of the court by registrar & the offender in relation to which the offence is so compounded shall be discharged.
7. The Regional Director or officer authorised by the CG, may direct any partner, designated partner or other employee of LLP to file or register, or on payment of fee or additional fee as required to be paid under this Act
8. In case of failure to comply with the above order, twice the amount of maximum fine can be imposed

Partner's Transferable Interest [Section 42]

1. The rights of a partner to a share of the profits and losses of LLP and to receive distributions in accordance with LLP agreement are transferable either wholly or in part.
2. The transfer of any right by any partner pursuant to sub-section (1) does not by itself cause the disassociation of the partner or a dissolution and winding up of LLP.
3. The transfer of right pursuant to this section does not, by itself, entitle the transferee or assignee to participate in the management or conduct of the activities of LLP, or access information concerning the transactions of LLP.

Conversion INTO LLP

| | | |
|------------|----------------------------------|-----------------|
| Section 55 | Firm into LLP | Second Schedule |
| Section 56 | Private Company into LLP | Third Schedule |
| Section 57 | Unlisted Public Company into LLP | Fourth Schedule |

Registration and Effect of Conversion [Section 58]

1. Registrar shall register documents submitted under schedule and issue certificate of registration
2. LLP shall within 15 days to inform registrar of firm/company
3. Upon conversion, LLP & partners shall be bound by provisions of the schedule
4. Effect of Conversion –
 1. There shall be LLP with name specified in the certificate
 2. All property shall vest in LLP
 3. Firm or Company shall be deemed to dissolved

Foreign LLPs [Section 59]

The CG may make rules for provisions in relation to establishment of place of business by foreign LLP within India and carrying on their business therein by applying or incorporating, with such modifications, as appear appropriate, the provisions of the Companies Act, 2013 or such regulatory mechanism with such composition as may be prescribed.

Compromise, Arrangement OR Reconstruction of LLPS

Compromise or arrangement of LLPs [Section 60]

1. **Application with Tribunal** for compromise or arrangement
 - a. between a LLP and its creditors; or
 - b. between a LLP and its partners,

can be **filed by LLP or any creditor or partner of LLP**, or, in the case of a LLP which is being wound up, by **the liquidator**,
2. Tribunal may **order a meeting of creditors or of partners**, as the case may be, to be called, held and conducted in manner prescribed or as Tribunal directs.
3. If a **majority in number representing three-fourths in value** of the creditors, or partners, at the meeting, agree to any compromise or arrangement, & if approved by the Tribunal by **order be binding on all the creditors or all the partners**, as the case may be, and also on LLP, or in the case of a LLP which is being wound up, on the liquidator and contributories of LLP:
4. All **material facts relating to LLP to be disclosed to Tribunal**, including the latest financial position of LLP and the pendency of any investigation proceedings in relation to LLP.
5. An order made by Tribunal shall be filed by LLP with the Registrar within 30 days after making such an order and shall have effect only after it is so filed.

Power of Tribunal to enforce compromise or arrangement (Section 61)

1. Tribunal
 - a. shall have **power to supervise** the carrying out of the compromise or an arrangement; and
 - b. May **give such directions or make such modifications** in the compromise or arrangement as **it may consider necessary** for the proper working of the compromise or arrangement.
2. If the Tribunal aforesaid is satisfied that a compromise or an arrangement sanctioned cannot be worked satisfactorily with or without modifications, **Tribunal may make an order for winding up of LLP**

Provisions for facilitating reconstruction or amalgamation of LLPs [Section 62]

1. Where an application is made to the Tribunal for sanctioning of a compromise or arrangement and it is shown to Tribunal that—
 - a. compromise or arrangement involves reconstruction of any LLP the amalgamation of any two or more LLPs; and
 - b. property or liabilities of any LLP is to be transferred to another LLP, then Tribunal may make provisions for all or any of the following matters, namely:—
 - i. the transfer to the transferee LLP of the whole or any part of the undertaking, property or liabilities of any transferor LLP;
 - ii. the continuation by or against the transferee LLP of any legal proceedings pending by or against any transferor LLP;
 - iii. the dissolution, without winding up, of any transferor LLP;
 - iv. the provision to be made for any person who, within such time and in such manner as the Tribunal directs, dissent from the compromise or arrangement; and
 - v. such incidental, consequential and supplemental matters as are necessary to secure that the reconstruction or amalgamation shall be fully and effectively carried out:
2. Within 30 days after order date, every LLP shall cause a certified copy of order to be filed with the Registrar for registration.

Winding up and Dissolution

Winding up and dissolution [Section 63]: The winding up of a LLP may be either voluntary or by the Tribunal and LLP, so wound up may be dissolved.

Circumstances in which LLP may be wound up by Tribunal [Section 64]: A LLP may be wound up by the Tribunal:

- a. if **LLP decides that LLP be wound up by the Tribunal;**
- b. if, for a period of more than six months, the **number of partners** of LLP is **reduced below two;**
- c. if LLP has acted **against the interests of the sovereignty and integrity** of India, the security

of the State or public order;

- d. if LLP has made a **default in filing** with the Registrar the Statement of Account and Solvency or annual return for **any five consecutive financial years**; or
- e. if the Tribunal is of the opinion that it is **just and equitable** that LLP be wound up.

Rules for winding up and dissolution [Section 65]: The CG may make rules for the provisions in relation to winding up and dissolution of LLP.

Business Transactions of Partner with LLP [Section 66]

A partner may lend money to and transact other business with LLP and has the same rights and obligations with respect to the loan or other transactions as a person who is not a partner.

Application of the Provisions of the Companies Act [Section 67]

1. The CG may direct that any of the provisions of the Companies Act, 2013 specified in the notification **shall apply to any LLP** with such exception, modification and adaptation, as may be specified, in the notification.
2. A copy of every notification proposed to be issued
 - ◆ shall be laid in draft before each House of Parliament, while it is in session,
 - ◆ for a total period of 30 days

Payment of Additional Fee [Section 69]

Any document or return if not registered or filed in time may be registered or filed after that time, **on payment of such additional fee** as may be prescribed in addition to any fee as is payable for filing of such document or return

Enhanced Punishment [Section 70]

Second or subsequent offence, be punishable with

- imprisonment as provided,
- fine which shall be **twice the amount of fine for such offence.**

THE GENERAL CLAUSES ACT, 1897

Introduction

Why we study General Clauses Act?

The General Clauses Act, 1897 (Act) was enacted on 11th March, 1897 to consolidate and extend the General Clauses Act, 1868 and 1887.

The General Clauses Act, 1897 contains 'definitions' of certain terms and general principles of interpretation.

Object, Purpose and Importance of the General Clauses Act

The objects of the Act are several, namely:

- (1) to shorten the language of Central Acts;
- (2) to provide, as far as possible, for uniformity of expression in Central Acts, by giving definitions of a series of terms in common use;
- (3) To state explicitly certain convenient rules for the construction and interpretation of Central Acts;
- (4) To guard against slips and oversights by importing into every Act certain common form clauses, which otherwise ought to be inserted in every central Act.

Application of the General Clauses Act

The Act does not define any "territorial extent" clause.

Its application is to rules and regulations made under a Central Act.

It is in a sense a part of every Central Acts or Regulations.

If a Central Act is extended to any territory, the General Clauses Act would also deem to be applicable in that territory and would apply in the construction of that Central Act.

Article 367 of the Constitution of India authorises use of the General Clauses Act for the interpretation of constitution. Article 367 states that:

"Unless the context otherwise requires, the General Clauses Act, 1897, shall, subject to any adaptations and modifications that may be made therein under Article 372, apply for the interpretation of this Constitution as it applies for the interpretation of an Act of the Legislature of the Dominion of India".

Section 1

"Short title" [Section 1(1)]:

This Act may be called the General Clauses Act, 1897.

The General Clauses Act, 1897 contains only short title in the Preliminary part of the Act.

Definitions [Section 3]

“Act” [Section 3(2)]: ‘Act’, used with reference to an offence or a civil wrong, shall include a series of acts, and words which refer to acts done extend also to illegal omissions;

An act required to be done cannot necessarily mean a positive act only and may also include acts which one is precluded from doing from decree.

The act by which A causes Z's death consists of a series of acts, namely, the blows given in beating him, plus a series of illegal omissions, namely, wrongfully neglecting or refusing to supply him with food at proper times.

“Affidavit” [Section 3(3)]: ‘Affidavit’ shall include affirmation and declaration in the case of persons by law allowed to affirm or declare instead of swearing.

The above definition is inclusive in nature.

This definition does not define affidavit.

In general parlance, affidavit is a written statement confirmed by oath or affirmation for use as evidence in Court or before any authority.

“Central Act” [Section 3(7)]: ‘Central Act’ shall mean an Act of Parliament, and shall include-

- (a) An Act of the Dominion Legislature or of the Indian Legislature passed before the commencement of the Constitution*, and
- (b) An Act made before such commencement by the Governor General in Council or the Governor General, acting in a legislative capacity;

“Central Government” [Section 3(8)]:

‘Central Government’ shall-

- (a) In relation to anything done before the commencement of the Constitution, mean the Governor General in Council,
- (b) In relation to anything done or to be done after the commencement of the constitution of the Constitution, mean the President;

“Commencement” [Section 3(13)]: ‘Commencement’ used with reference to an Act or Regulation, shall mean the day on which the Act or Regulation comes into force;

Coming into force or entry into force (also called commencement) refers to the process by which legislation; regulations, treaties and other legal instruments come to have legal force and effect.

A Law cannot be said to be in force unless it is brought into operation by legislative enactment, or by the exercise of authority by a delegate empowered to bring it into operation.

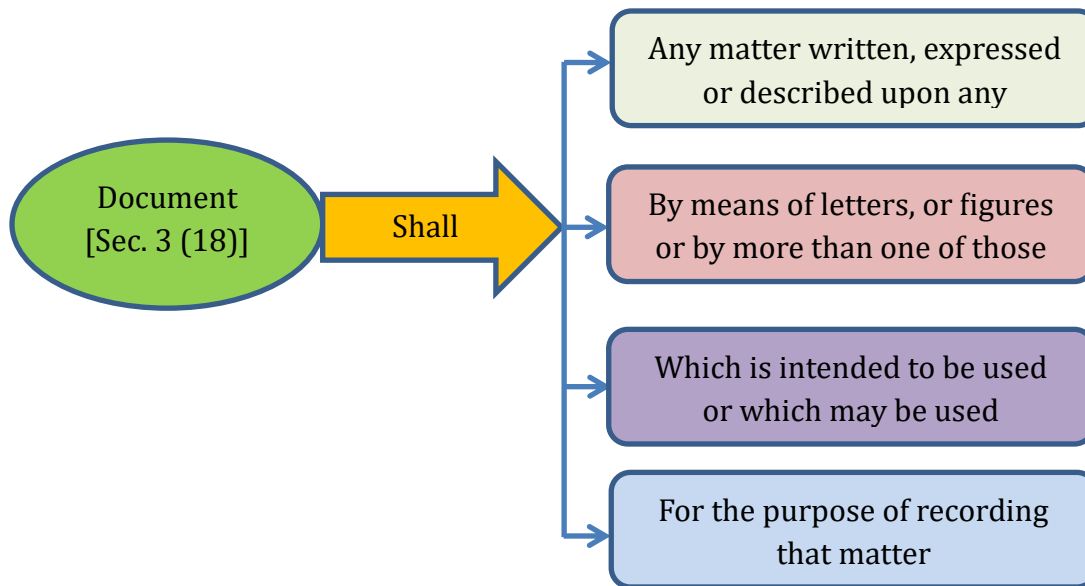

For example, book, file, painting, inscription and even computer files are all documents. However, it does not include Indian currency notes.

“Financial Year” [Section 3(21)]:

Financial year shall mean the year **commencing on the first day of April**.

The term Year has been defined under Section 3(66) *as a year reckoned according to the British calendar*.

Thus, as per General Clauses Act, Year means calendar year which starts from January to December.

Difference between Financial Year and Calendar Year: Financial year starts from first day of April but Calendar Year starts from first day of January.

“Good Faith” [Section 3(22)]: A thing shall be deemed to be **done** in “good faith” where it is in fact done **honestly, whether it is done negligently or not;**

The question of good faith under the General Clauses Act, 1897 is one of fact. It is to determine with reference to the facts and circumstances of each case. Thus, anything done with due care and attention, which is not *malafide* is presumed to have been done in good faith. For eg: An authority is not acting honestly where it had a suspicion that there was something wrong and did not make further enquiries

In *Maung Aung Pu Vs. Maung Si Maung*, it was pointed out that the **expression “good faith” is not defined in the Indian Contract Act, 1872 and the definition given here in the General Clauses Act, 1897 does not expressly apply the term on the Indian Contract Act.**

The definition of **good faith as is generally understood in the civil law** and which may be taken as a practical guide in understanding the expression in the contract Act is that nothing is said to be done in good faith which is done without due care and attention as is expected with a man of ordinary prudence.

An honest purchase made carelessly without making proper enquiries cannot be said to have been made in good faith so as to convey good title.

“Government” [Section 3(23)]: ‘Government’ or ‘the Government’ shall include both the Central Government and State Government.

In Wider Sense, Government generally connotes three wings, the Legislature, the Executive and the Judiciary;

but in a narrow sense it is used to connote the Executive only.

Which meaning to be assigned to word government, therefore, depends on the context in which it is used.

“Government Securities” [Section 3(24)]: ‘Government securities’ shall mean securities of the Central Government or of any State Government, but in any Act or Regulation made before the commencement of the Constitution shall not include securities of the Government of any Part B state.

“Immovable Property” [Section 3(26)]:

Immovable Property’ shall include:

- (i) Land,
- (ii) Benefits to arise out of land, and
- (iii) Things attached to the earth, or
- (iv) Permanently fastened to anything attached to the earth.

Example : In *Shantabai v. State of Bombay*, the Supreme Court pointed out that trees must be regarded as immovable property because they are attached to or rooted in the earth.

An agreement to convey forest produce like tendu leaves, timber, bamboos etc., the soil for making bricks, the right to build on and occupy the land for business purposes and the right to grow new trees and to get leaves from trees that grow in further are all included in the term immovable property.

Right of way to access from one place to another, may come within the definition of Immovable property whereas to right to drain of water is not immovable property.

Any machinery fixed to the soil, standing crops can be held as immovable property according to the General Clauses Act, 1897.

“Imprisonment” [Section 3(27)]: ‘Imprisonment’ shall mean imprisonment of either description as defined in the Indian Penal Code;

By section 53 of the Indian Penal Code, the punishment to which offenders are liable under that Code are imprisonment which is of two descriptions, namely, rigorous, that is with hard labor and simple.

So, when an Act provides that an offence is punishable with imprisonment, the Court may, in its discretion, make the imprisonment rigorous or simple.

“Month” [Section 3(35)]: ‘Month’ shall mean a month reckoned according to the British calendar;

“Movable Property” [Section 3(36)]: ‘Movable Property’ shall mean property of every description, except immovable property.

Debts, share, electricity are moveable property.

“Oath” [Section 3(37)]: ‘Oath’ shall include affirmation and declaration in the case of persons by law allowed to affirm or declare instead of swearing.

“Offence” [Section 3(38)]: ‘Offence’ shall mean any act or omission made punishable by any law for the time being in force.

“Official Gazette” [Section 3(39)]:

‘Official Gazette’ or ‘Gazette’ shall mean:

- (i) **The Gazette of India**, or
- (ii) **The Official Gazette of a state**.

The Gazette of India is a public journal and an authorised legal document of the Government of India, **published weekly by the Department of Publication**, Ministry of Housing and Urban Affairs.

As a public journal, the Gazette prints official notices from the government. It is authentic in content, accurate and strictly in accordance with the Government policies and decisions. The gazette is **printed by the Government of India Press**.

“Person” [Section 3(42)]: “Person” shall include:

- (i) any company, or
- (ii) association, or
- (iii) body of individuals, whether incorporated or not

“Registered” [Section 3(49)]: ‘Registered’ used with reference to a document, shall **mean registered in India under the law** for the time being force for the registration of documents.

“Rule” [Section 3(51)]: ‘Rule’ shall mean a rule made in exercise of a power conferred by any enactment, and shall include a Regulation made as a rule under any enactment;

“Schedule” [Section 3(52)]: ‘Schedule’ shall mean a schedule to the Act or Regulation in which the word occurs;

“Section” [Section 3(54)]: ‘Section’ shall mean a section of the Act or Regulation in which the word occurs;

Other Definitions [Section 3]

“Sub-section” [Section 3(61)]: ‘Sub-section’ shall mean a sub-section of the section in which the word occurs;

“Swear” [Section 3(62)]: “Swear”, with its grammatical variations and cognate expressions, shall include affirming and declaring in the case of persons by law allowed to affirm or declare instead of swearing.

Note: The terms “Affidavit”, “Oath” and “Swear” have the same definitions in the Act.

“Writing” [Section 3(65)]: Expressions referring to ‘writing’ shall be construed as including references to printing, lithography, photography and other modes of representing or reproducing words in a ²visible forms.

“Year” [Section 3(66)]: ‘Year’ shall mean a year reckoned according to the British calendar.

General Rules of Construction

“Coming into operation of enactment” [Section 5]: Where any Central Act has **not specifically mentioned a particular date** to come into force, it shall be **implemented on the day on which it receives the assent** of the Governor General in case of a Central Acts made before the commencement of the Indian Constitution and/or, of **the President** in case of an Act of Parliament.

Example : The Companies Act, 2013 received assent of President of India on 29th August, 2013 and was notified in Official Gazette on 30th August, 2013 with the enforcement of section 1 of the Act. Accordingly, the Companies Act, 2013 came into enforcement on the date of its publication in the Official Gazette.

Where, if any specific date of enforcement is prescribed in the Official Gazette, Act shall into enforcement from such date.

Example : SEBI (Issue of Capital and Disclosure Requirements) (Fifth Amendment) Regulations, 2015 was issued by SEBI vide Notification dated 14th August, 2015 with effect from 1 January, 2016. Here, this regulation shall come into force on 1st January, 2016 rather than the date of its notification in the gazette.

Where an Act empowers the government to bring any of the provisions into operation on any day which it deems fit, no Court can issue a mandamus with a view to compel the Government to bring the same into operation on particular day.

It was held that if a sufficient time has elapsed since an Act or any of its provisions has been passed and it has not been brought into force (operation) by the Government, the Court through a writ can direct the Government to consider the question as to when the same should begin to operate.

Also, law takes no cognizance of fraction of day, thus where an Act provides that it is to come into force on the first day of January, it will come into force on as soon as the clock has struck 12 on the night of 31st December.

PRESUMPTION AGAINST RETROSPECTIVITY

All laws which affect substantive vested rights **generally operate prospectively** and there is a presumption against their retrospectivity till there are express words giving retrospective effect or where the language used necessarily implies that such retrospective operation is intended.

Hence, **the question whether a statutory provision has retrospective effect or not depends primarily on the language** in which it is couched.

“Effect of Repeal” [Section 6]: Where any Central legislation or any regulation made after the commencement of this Act repeals any Act made or yet to be made, unless another purpose exists, the **repeal shall not:**

- **Revive anything not enforced** or prevailed during the period at which repeal is effected or;

- Affect the previous operation of any enactment so repealed or anything duly done or suffered thereunder; or
- Affect any right, privilege, obligation or liability acquired, accrued or incurred under any enactment so repealed; or
- Affect any penalty, forfeiture or punishment incurred in respect of any offence committed against any enactment so repealed; or
- Affect any inquiry, litigation or remedy with regard to such claim, privilege, debt or responsibility or any inquiry, litigation or remedy may be initiated, continued or insisted.

In *Navrangpura Gam Dharmada Milkat Trust v. Ramtuji Ramaji*, AIR 1994 Guj 75:

‘Repeal’ of provision is in distinction from ‘deletion’ of provision.

‘Repeal’ ordinarily brings about complete obliteration of the provision as if it never existed, thereby affecting all incoherent rights and all causes of action related to the ‘repealed’ provision

while ‘deletion’ ordinarily takes effect from the date of legislature affecting the said deletion, never to effect total effecting or wiping out of the provision as if it never existed.

For the purpose of this section, the above distinction between the two is essential.

“Repeal of Act making textual amendment in Act or Regulation” [Section 6A]-

Where any Central Act or Regulation made after the commencement of this Act repeals any enactment by which the text of any Central Act or Regulation was amended by the express omission, insertion or substitution of any matter,

then unless a different intention appears, the repeal shall not affect the continuance of any such amendment made by the enactment so repealed and in operation at the time of such repeal.

“Revival of repealed enactments” [Section 7]- (1) In any Central Act or Regulation made after the commencement of this Act, it shall be necessary, for the purpose of reviving, either wholly or partially, any enactment wholly or partially repealed, expressed to state that purpose.

In other words, to revive a repealed statute, it is necessary to state an intention to do so.

“Construction of references to repealed enactments” [Section 8]-

(1) Where this Act or Central Act or Regulation made after the commencement of this Act, repeals and re-enacts, with or without modification, any provision of a former enactment, then references in any other enactment or in any instrument to the provision so repealed shall, unless a different intention appears, be construed as references to the provision so re-enacted.

In section 115 JB of the Income Tax Act, 1961, for calculation of book profits, the Companies Act, 1956 are required to be referred. With the advent of Companies Act, 2013, the corresponding change has not been made in section 115 JB of the Income Tax Act, 1961. On referring of section 8 of the General Clauses Act, book profits to be calculated under section 115 JB of the Income Tax Act will be as per the Companies Act, 2013.

“Commencement and termination of time” [Section 9]:

In any legislation or regulation, it shall be sufficient, for the purpose of **excluding the first** in a series of days or any other period of time to **use the word “from”** and for the purpose of **including the last** in a series of days or any other period of time, **to use the word “to”**.

Example: A company declares dividend for its shareholder in its Annual General Meeting held on 30/09/2022. Under the provisions of the Companies Act, 2013, company is required to pay declared dividend within 30 days from the date of declaration i.e. from 01/10/2022 to 30/10/2022. In this series of 30 days, 30/09/2022 will be excluded and last 30th day i.e. 30/10/2022 will be included.

“Computation of time” [Section 10]:

Where by any legislation or regulation, **any act or proceeding is directed or allowed to be done or taken in any court or office on a certain day or within a prescribed period** then, if the **Court or office is closed on that day or last day of the prescribed period**, the act or proceeding shall be considered as done or taken in due time if it is done or taken on **the next day afterwards on which the Court or office is open**.

“Measurement of Distances” [Section 11]:

In the measurement of any distance, for the purposes of any Central Act or Regulation made after the commencement of this Act, that distance shall, unless a different intention appears, be measured in a straight line on a horizontal plane.

“Duty to be taken pro rata in enactments” [Section 12]: Where, by any enactment now in force or hereafter to be in force, **any duty of customs or excise or in the nature thereof, is leviable on any given quantity, by weight, measure or value of any goods or merchandise, then a like duty is leviable according to the same rate on any greater or less quantity.**

Pro rata is a Latin term used to describe a proportionate allocation.

Example: Where several debtors are liable for the whole debt and each is liable for his own share or proportion only, they are said to be bound pro rata.

“Gender and number” [Section 13]: In all legislations and regulations, **unless there is anything repugnant in the subject or context-**

(1) Words importing the **masculine gender** shall be taken to **include females**, and

(2) Words in **singular shall include the plural and vice versa**.

Exception :- Where a **word connoting a common gender is available** but the word used conveys a specific gender, there is a **presumption that the provisions of General Clauses Act, 1897 do not apply**.

The words “male descendants” occurring in Section 7 and Section 8 of the Chota Nagpur Tenancy Act, 1908 were not interpreted to include female descendants.

Thus, the word ‘bullocks’ could not be interpreted to include ‘cows’.

Power and Functionaries

“Power conferred to be exercisable from time to time” [Section 14]: (1) Where, by any Central Act or Regulation made after the commencement of this Act, any power is conferred, then unless a different intention appears that power may be exercised from time to time as occasion requires.

“Power to appoint to include power to appoint ex-officio” [Section 15]:

Where by any legislation or regulation, a power to appoint any person to fill any office or execute any function is conferred,

then unless it is otherwise expressly provided, any such appointment, may be made either by name or by virtue of office.

Ex-officio is a Latin word which means by virtue of one’s position or office.

“Power to appoint to include power to suspend or dismiss” [Section 16]:

The authority having for the time being power to make the appointment shall also have power to suspend or dismiss any person appointed whether by itself or any other authority in exercise of that power.

Example - Where Law authorises a court to appoint a receiver, has been construed to embrace power of removing a receiver.

Article 229(1) of the Constitution which empowers the Chief Justice to make appointment of officers and servants of a High Court has been interpreted to include a power to suspend or dismiss.

“Substitution of functionaries” [Section 17]:

(1) In any Central Act or Regulation made after the commencement of this Act, it shall be sufficient,

for the purpose of indicating the application of a law to every person or number of persons for the time being executing the functions of an office,

to mention the official title of the officer at present executing the functions, or that of the officer by whom the functions are commonly executed.

“Successors” [Section 18]: (1) In any Central Act or Regulation made after the commencement of this Act, it shall be sufficient, for the purpose of indicating the relation of a law to the successors of any functionaries or of corporations having perpetual succession, to express its relation to the functionaries or corporations.

“Official Chiefs and subordinates” [Section 19]: A law relative to the chief or superior of an office shall apply to the deputies or subordinates lawfully performing the duties of that office in the place of their superior, to prescribe the duty of the superior

Provision as to Orders, Rules ETC. Made under Enactments

“Construction of orders, etc., issued under enactments” [Section 20]:

Where by any legislation or regulation, a power to issue any notification, order, scheme, rule, form, or by-law is conferred, then **expression used in the notification**, order, scheme, rule, form or bye-law, shall, unless there is anything repugnant in the subject or context, **have the same respective meaning as in the Act** or regulation conferring power.

Example : The term ‘collector’ used in Rule 4 of the Land Acquisition (Companies) Rule, 1963, will have the same meaning as in Section 3(c) of the Land Acquisition Act, 1894.

“Power to issue, to include power to add to, amend, vary or rescind notifications, orders, rules or bye-laws” [Section 21]:

Where by any legislations or regulations a **power to issue** notifications, orders, rules or bye-laws **is conferred**, then that power, exercisable in the like manner and subject to the like sanction and conditions, **to add, to amend, vary or rescind** any notifications, orders, rules or bye laws so issued.

In *one of the case law*, Supreme Court held that under Section 21 of the Act, an authority which has the power to issue a notification has the undoubted power to rescind or modify the notification in the like manner.

“Making of rules or bye-laws and issuing of orders between passing and commencement of enactment” [Section 22]:

Where, by any Central Act or Regulation which is not to come into force immediately, on the passing thereof, a **power is conferred to make rules or bye-laws**, or to issue orders with respect to the application of the Act or Regulation or with respect to the establishment of any Court or the appointment of any Judge or officer thereunder, or with respect to the person by whom, or the time when, or the place where, or the manner in which, or the fees for which, anything is to be done under the Act or Regulation, then that **power may be exercised at any time after passing of the Act or Regulation**; but rules, bye-laws or orders so made or issued shall not take effect till the commencement of the Act or Regulation.

“Provisions applicable to making of rules or bye-laws after previous publications” [Section 23]: Where, by any Central Act or Regulation, a power to make rules or bye-laws is expressed to be given subject to the condition of the rules or bye-laws being made after previous publication, then the following provisions shall apply, namely:-

- (1) The authority having power to make the rules or bye-laws shall, before making them, **publish a draft of the proposed rules** or bye-laws for the information of persons likely to be affected thereby;
- (2) The publication shall be made in such manner as that authority deems to be sufficient, or, if the condition with respect to previous publication so requires, in such manner as the Government concerned prescribes;

- (3) There shall be published with the draft a notice specifying a date on or after which the draft will be taken into consideration;
- (4) The authority having power to make the rules or bye-laws, and, where the rules or bye-laws are to be made with the sanction, approval or concurrence of another authority, that authority also shall consider any objection or suggestion which may be received by the authority having power to make the rules or bye-laws from any person with respect to the draft before the date so specified;
- (5) The publication in the Official Gazette of a rule or bye-law purporting to have been made in exercise of a power to make rules or bye-laws after previous publication shall be conclusive proof that the rule or bye-laws has been duly made.

Section 23(5) raises a conclusive presumption that after the publication of the rules in the Official Gazette, it is to be inferred that the procedure for making the rules had been followed. **Any irregularities in the publication of the draft cannot therefore be questioned.**

It is also open to the authority publishing the draft and entitled to make the rules to make suitable changes in the draft before finally publishing them. It is **not necessary for that authority to re-publish the rules in the amended form before their final issue** so long as the changes made are ancillary to the earlier draft and cannot be regarded as foreign to the subject matter thereof.

“Continuation of orders etc., issued under enactments repealed and re-enacted”

[Section 24]: Where any Central Act or Regulation, is, after, the commencement of this Act, repealed and re-enacted with or without modification, then unless it is otherwise expressly provided any appointment notification, order, scheme, rule, form or bye-law, made or issued under the repealed Act, continue in force, and be deemed to have been made or issued under the notification, order, scheme, rule, form or bye-law, made or issued under the provisions so re-enacted

The Mines Act of 1923 was repealed and replaced by the Mines Act of 1952. Rules made under the repealed Act must be deemed to continue in force by virtue of this section until superseded.

Miscellaneous

“Recovery of fines” [Section 25]: Section 63 to 70 of the Indian Penal Code and the provisions of the Code of Criminal Procedure for the time being in force in relation to the issue and the execution of warrants for the levy of fines shall apply to all fines imposed under any Act, Regulation, rule or bye-laws, unless the Act, Regulation, rule or bye-law contains an express provision to the contrary.

“Provision as to offence punishable under two or more enactments” [Section 26]: Where an act or omission constitutes an offence under two or more enactments, then the offender shall be liable to be prosecuted and punished under either or any of those enactments, but shall not be punished twice for the same offence.

Article 20(2) of the Constitution states that no person shall be prosecuted and punished for the same offence more than once.

According to the Supreme Court, a plain reading of section 26 shows that there is no bar to the trial or conviction of an offender under two enactments, but there is only a bar to the punishment of the offender twice for the same offence.

Provisions of Section 26 and Article 20(2) of the Constitution apply only when the two offences which form the subject of prosecution is the same, i.e., the ingredients which constitute the two offences are the same. If the offences under the two enactments are distinct and not identical, none of these provisions will apply.

“Meaning of Service by post” [Section 27]: Where any legislation or regulation requires any document to be served by post, then unless a different intention appears, **the service shall be deemed to be effected by:**

- (i) Properly addressing
- (ii) Pre-paying, and
- (iii) Posting by registered post.

A letter containing the document to have been effected at the time at which the letter would be delivered in the ordinary course of post.

- A notice when required under the statutory rules to be sent by ‘registered post acknowledgement due’ is instead sent by ‘registered post’ only, the protection of presumption regarding **servicing of notice under ‘registered post’** under this section of the Act **neither tenable nor based upon sound exposition of law.**
- It was held that where a **notice is sent to the landlord by registered post and the same is returned by the tenant** with an endorsement of refusal, **it will be presumed that the notice has been served.**
- It was held that where notice sent by registered post to person concerned at proper address is deemed to be served upon him in due course unless contrary is proved. **Endorsement ‘not claimed/not met’ is sufficient to prove deemed service of notice.**

“Citation of enactments” [Section 28]: (1) In any Central Act or Regulation, and in any rule, bye law, instrument or document, made under, or with reference to any such Act or Regulation, any enactment may be **cited by reference to the title or short title** (if any) conferred thereon or by reference to the number and years thereof, and any provision in an enactment may be **cited by reference to the section or sub-section of the enactment** in which the provision is contained.

In this Act and in any Central Act or Regulation made after the commencement of this Act, a description or citation of a portion of another enactment shall, unless a different intention appears, be construed as **including the word, section** or other part mentioned or referred to as forming the **beginning and as forming the end of the portion comprised in the description or citation.**

INTERPRETATION OF STATUTES

Statute

- For a common man, ‘Statute’ generally means laws and regulations of various kinds irrespective of the source from which they emanate.
- In India ‘statute’ means an enacted law by the Parliament or by the state legislature.
- However, the Constitution does not use the terms ‘statute’ though one finds the terms ‘law’ used in many places.
- In short ‘statute’ signifies written law as against unwritten law.

Document

For definition of Document given under General clauses act refer chapter 13- General Clauses Act, 1897

Section 3 of the Indian Evidence Act, 1872 states that ‘document’ means any matter expressed or described upon any substance by means of letters, figures or marks or by more than one of those means, intended to be used, or which may be used, for the purpose of recording that matter.

Example : A writing is a document; any words printed, photographed are documents.

What are the four elements of Document?

- Matter—This is the first element. Its usage with the word “any” shows that the definition of document is comprehensive.
- Record—This second element must be certain mutual or mechanical device employed on the substance. It must be by writing, expression or description.
- Substance—This is the third element on which a mental or intellectual elements comes to find a permanent form.
- Means—This represents forth element by which such permanent form is acquired and those can be letters, any figures, marks, symbols which can be used to communicate between two persons.

Instrument

‘Instrument’:

- For a common man, ‘instrument’ means a formal legal document which creates or confirms a right or records a fact.
- It also means a formal legal document having legal effect, either as creating a right or liability or as affording evidence of it.
- Section 2(14) of the Indian Stamp Act, 1899 states that ‘instrument’ includes every document by which any right or liability is or purports to be created, transferred, extended, extinguished or recorded.
- **Examples :-** Agreement, Deed, charter etc.

Deed

‘Deed’:

- In India, no distinction seems to be made between instruments and deeds.
- ‘Deed’ as an instrument in writing (or other legible representation or words on parchment or paper) purporting to effect some legal disposition.
- All deeds are instruments though all instruments may not be deeds.

Interpretation

‘Interpretation’:

Interpretation means the process by which the Courts seek to ascertain the meaning of the legislature through the medium of the words in which it is expressed.

In Simple words, ‘interpretation’ is the process by which the real meaning of an Act or a document and the intention of the legislature in enacting it or of the parties executing the document is ascertained.

Importance of Interpretation:

The process of statute making and the process of interpretation of statutes take place separately from each other, and two different agencies are concerned.

Interpretation serves as the bridge of understanding between the two.

Classification by Jolowicz

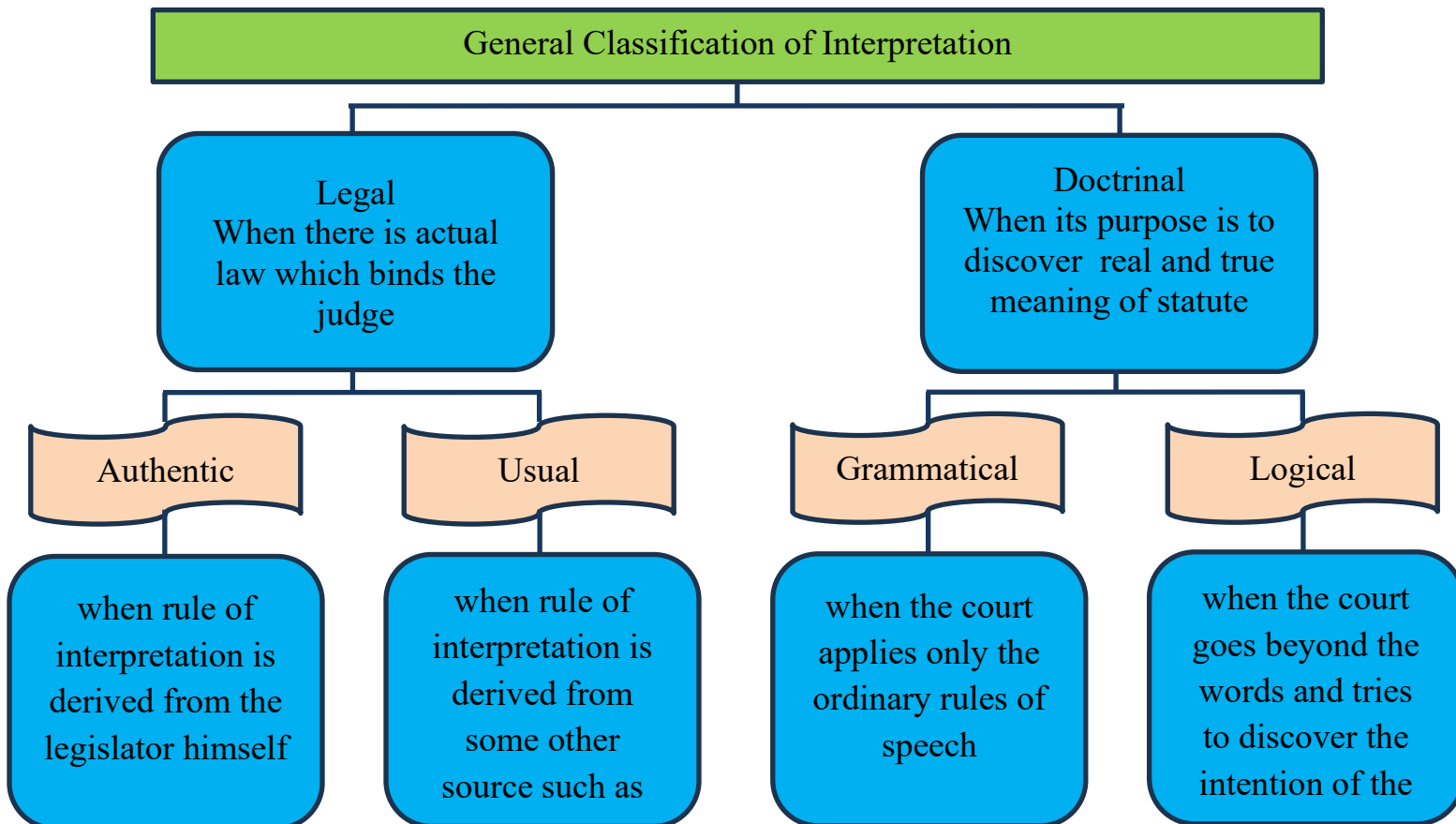

Classification by Fitzgerald

According to Fitzgerald, interpretation is of two kinds – ‘literal’ and ‘functional’.

The **literal interpretation** is that which regards **conclusively the verbal expression of the law**. The duty of the Court is to ascertain the intention of the legislature and seek for that intent in every legitimate way, but first of all in the words and the language employed.

‘Functional’ interpretation is that which departs from the letter of the law and seeks elsewhere for some other and more satisfactory evidence of the true intention of the legislature.

Construction

- ‘Construction’ as applied to a written statute or document means **to determine** from its known elements its **true meaning or the intention of its framers**.
- Construction involves drawing **conclusions beyond the actual expressions** used in the text.
- This is done by referring to other parts of the enactment and the context in which the law was made.
- Thus, **when you do construction of a statute you are attempting to ascertain the intention of the legislature**.

Difference

Difference between Interpretation and Construction:

- While more often **these two terms are used interchangeably** but these two terms have different connotations.
- **Interpretation is the art of ascertaining the meaning of words** and the true sense in which the author intended that they should be understood.
- Thus, where the Court adheres to the plain meaning of the language used by the legislature, it would be ‘interpretation’ of the words.
- But **where the meaning is not plain, the court has to decide whether the wording was meant to cover the situation before the court**. Here, the court would be resorting to ‘construction’.

Rules of interpretation/construction

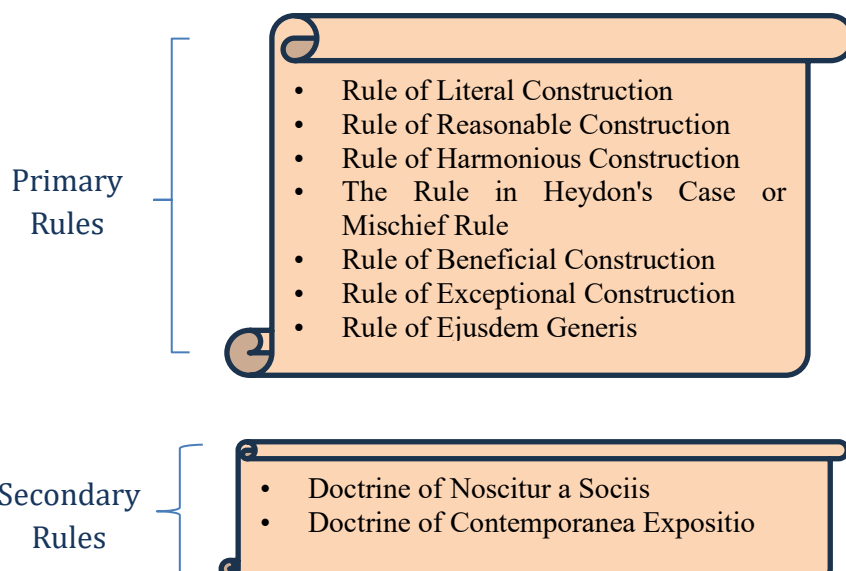

Rules of Literal construction

- The first and **primary rule of construction** is that the intention of the legislature must be found in the words used by the legislature itself.
- It is a **cardinal rule of construction** that a **statute must be construed literally and grammatically** giving the words their ordinary and natural meaning.
- It is the **primary duty of the court to interpret the words used in legislation according to their ordinary grammatical meaning** in the absence of any ambiguity or doubt.
- Normally, **where the words of a statute are in themselves clear and unambiguous**, then these words should be construed in their natural and ordinary sense and **it is not open to the court to adopt any other hypothetical construction**. This is called the rule of literal construction.
- This principle is contained in the Latin maxim "*absoluta sententia expositore non indiget*" which literally means "**an absolute sentence or preposition needs not an expositor**". In other words, **plain words require no explanation**.

Narrow Vs Wider Interpretation

Sometimes, occasions may arise when a choice has to be made between two interpretations – **one narrower and the other wider**. In such a situation, **if the narrower interpretation would fail to achieve the purpose of the legislation, one should rather adopt the wider one**.

When we talk of disclosure of 'the nature of concern or interest, financial or otherwise' of a director or the manager of a company in the subject-matter of a proposed motion (as referred to in section 102 of the Companies Act, 2013), we have to interpret in its broader sense of referring to any concern or interest containing any information and facts that may enable members to understand the meaning, scope and implications of the items of business and to take decisions thereon.

What is required is a full and frank disclosure without reservation or suppression, as, for instance where a son or daughter or father or mother or brother or sister is concerned in any contract or matter, the shareholders ought fairly to be informed of it and the material facts disclosed to them. Here a restricted narrow interpretation would defeat the very purpose of the disclosure.

Natural and grammatical meaning

Statutes are to be first understood in their natural, ordinary, or popular sense and must be construed according to their plain, literal and grammatical meaning.

Example :

In a question before the court whether the sale of betel leaves was subject to sales tax.

The Supreme Court held that betel leaves could not be given the dictionary, technical or botanical meaning when the ordinary and natural meaning is clear and unambiguous.

Being the word of everyday use, it must be understood in its popular sense by which people are conversant with it as also the meaning which the statute dealing with the matter would attribute to it. Therefore, the sale of betel leaves was liable to sale tax.

Rules of interpretation/ construction

Technical words are to be understood in technical sense: This point of literal construction is that **technical words are understood in the technical sense only.**

In construing the word 'practice' in the Supreme Court Advocates Act, 1951, it was observed that **practice of law generally involves the exercise of both the functions of acting and pleading on behalf of a litigant party.** When legislature confers upon an advocate the right to practice in a court, it is legitimate to understand that expression as authorizing him to appear and plead as well as to act on behalf of suitors in that court.

Rules of Reasonable construction

- According to this Rule, the words of a statute must be construed 'ut res magis valeat quam pereat' meaning thereby that **words of statute must be construed so as to lead to a sensible meaning.**
- Similarly, **when the grammatical interpretation leads to a absurdity then the courts shall interpret the statute so as to resolve the inconsistency**
- This principle is contained in the Latin maxim, interpretatio fienda est ut res magis valeat quam pereat. In short, Statues should be construed grammatically.
- This is **also called the Golden Rule of Interpretation.**
- When grammatical/literal interpretation leads to certain absurdity, it is **permissible to depart there from and to interpret the provision of the statutes in a manner so as to avoid that absurdity**

Rules of Harmonious construction

- The opposite of "harmony" is conflict.
- Thus, **this rule is applied when there is a conflict between two provisions of a statute.**
- It is a basic rule of interpretation that **if it is possible to avoid a conflict between two provisions on a proper construction thereof, then it is the duty of the court to so interpret them that they are in harmony with each other.**
- **A specific rule will override a general rule.**
- This principle is usually expressed by the maxim, "generalia specialibus non derogant".

In some cases, the statute may give a clear indication as to which provision is subservient and which overrides.

This is done by the use of the terms "subject to", "notwithstanding" and "without prejudice".

Subject to

When "subject to" used in a provision is that **same subject matter** is covered by that provision and by another provision subject to which it operates and there is a conflict between them, **then the latter will prevail over the former** provision which contains the word subject to.

This limitation cannot operate, when the subject matter of the two provisions is not the same.

Thus, **a clause that uses the words "subject to" is subservient to another.**

Example : Section 13(2) of the Companies Act, 2013, "Any change in the name of a company shall be subject to the provisions of sub-sections (2) and (3) of section 4 and shall not have effect except with the approval of the Central Government in writing."

This implies that the any change in the name of the company has to in accordance with the provisions of the section 4(2) and section 4(3) of the Companies Act, 2013.

Notwithstanding

- A clause that begins with the words “notwithstanding anything contained” is called a non-obstante clause.
- The notwithstanding clause has the effect of making the provision prevail over others.
- When this term is used then the clause will prevail over the other provision(s) mentioned therein.

Rules of interpretation/ construction

A notwithstanding clause can operate at four levels.

| Clause | Effect | Examples |
|--|--|---|
| Notwithstanding anything contained in another section or subsection of the statute | Clause will override such other section/subsection | Section 54, Section 76 of Companies Act, 2013 |
| Notwithstanding anything contained in a statute | Clause will override entire statute | Section 97, 106, 110 of Companies Act, 2013 |
| Notwithstanding anything contained in section or subsection or all provisions of another statute | Clause will prevail over the other enactment | Section 212(6) of the Companies Act, 2013 |
| Notwithstanding anything contained in any other law for the time being in force | Clause will override all other laws | Section 72(3), 77(3), 132(2), 132(4) of Companies Act, 2013 |

Without prejudice

When certain particular provisions follow general provisions and when it is stated that the particular provisions are without prejudice to those general provisions, then the particular provisions would not restrict the operation of the general provisions.

Example : Section 4(3) of the Companies Act, 2013, “Without prejudice to the provisions of sub-section (2), a company shall not be registered with a name which contains.....”

This implies that while registering (and deciding) the name of the company [as per section 4(3)], provisions of section 4(2) shall also be operative.

Rule in Heydon’s Case or Mischief Rule

Where the language used in a statute is capable of more than one interpretation, the most firmly established rule for construction is the principle laid down in Heydon’s case.

In Heydon’s case it was laid down that “for the true and sure interpretation of all Statutes in general, four things are to be considered.

- (1) What was the law before the making of the act?
- (2) What was the defect, mischief, hardship caused by the earlier law?

- (3) How does the act of Parliament seek to resolve or cure the mischief or deficiency?
- (4) What are the true reasons for the remedy?

And then the courts shall make such construction as will suppress the mischief and advance the remedy.”

Thus, applying Heydon’s case, courts will be bound to look at the state of the law at the time of the passing of the enactment and not only as it then stood, but under previous Statutes too.

Example - Application of this mischief rule is also well-found in the construction of section 2(d) of the Prize Competition Act, 1955. This section defines ‘prize competition’ as “any competition in which prizes are offered for the solution of any puzzle based upon the building up arrangement, combination or permutation of letters, words or figures”. The issue was whether the Act applies to competitions which involve substantial skill and are not in the nature of gambling. Supreme Court, after referring to the previous state of law, to the mischief that continued under that law and to the resolutions of various states under Article 252(1) authorizing Parliament to pass the Act has stated as follows: “having regard to the history of the legislation, the declared object thereof and the wording of the statute, we are of opinion that the competitions which are sought to be controlled and regulated by the Act are only those competitions in which success does not depend on any substantial degree of skill.”

Rules of Beneficial Construction

- This is strictly speaking not a rule but a method of interpreting a provision liberally.
- Beneficial construction will be given to a statute, which brings into effect provisions for improving the conditions of certain classes of people who are under privileged or who have not been treated fairly in the past.
- In such cases it is permissible to give an extended meaning to words or clauses in enactments.
- But this can only be done when two constructions are reasonably possible and not when the words in a statute are quite unequivocal.

Rules of Exceptional Construction

“And” and “Or”

General Rule :-

And - The word “and” is normally conjunctive.

In its conjunctive sense the word is used to conjoin words, clauses or sentences, signifying that something is to follow in addition to that, which precedes.

Or - The word “or” is a disjunctive particle that marks an alternative, generally corresponding to “either”, as “either this or that”.

Can “and” be read as “or” and vice versa?

The word “and” is normally conjunctive, while “or” is disjunctive. But sometimes “and” is read as “or” and vice versa to give effect to the manifest intention of the legislature as disclosed from the context.

Rules of interpretation / Construction

“May”, “Must” and “Shall”

‘May’ signifies permission and implies that the authority has been allowed **discretion**.

“Shall” in the normal sense imports a **command**.

‘Must’ is doubtlessly a word of **command**.

In all cases, however, the intention of the legislature will guide the interpreter in his search of meaning.

“May” though permissive sometimes has compulsory force and is to be read as shall. Although it is well – settled that ordinarily the word ‘may’ is always used in a permissive sense, there may be circumstances where this word will have to be construed as having been used in a mandatory or compulsory sense.

What is distinction between mandatory and directory provisions.

Mandatory - Where **the provision prescribes that the contemplated action be taken without any option then such provision will be called mandatory.**

Directory - Where, **the acting authority is vested with discretion, choice or judgment, the provision will be called directory.**

How to decide whether the statute is directory or mandatory?

The question is whether there is anything that makes it the duty of the person on whom the power is conferred to exercise that power. If it is so then the Statute is a mandatory one; otherwise it is directory.

The question as to whether a statute is mandatory depends upon the intent of the legislature and not upon the language in which the intent is clothed.

Rules of Eiusdem Generis

- The term ‘**eiusdem generis**’ means ‘**of the same kind or species**’.
- Where specific words pertaining to a class/category are followed by general words, the general words shall be construed as limited to the things of the same kind as those specified class/category.
- **This rule applies when:**
 - (1) **The statute contains an enumeration of specific words**
 - (2) **The subject of enumeration constitutes a class or category;**
 - (3) **That class or category is not exhausted by the enumeration**
 - (4) **General terms follow the enumeration; and**
 - (5) **There is no indication of a different legislative intent.**
- This rule has no application where the intention of the legislature is clear.

Exceptions:

- (1) If the preceding term is general, as well as that which follows this rule cannot be applied.
- (2) Where the particular words exhaust the whole genus.
- (3) Where the specific objects enumerated are essentially diverse in character.
- (4) Where there is an express intention of legislature that the general term shall not be read *eiusdem generis* the specific terms.

Doctrine of Noscitur a Sociis

Noscitur a Sociis means that when two or more words that are susceptible of analogous meaning, are coupled together they are understood to be used in their cognate sense.

Words used in the statute takes their colour from each other, that is the meaning of the more general word being restricted to a sense analogous to that of the less general.

Examples of the principal of Noscitur a Sociis are as follows:

Fresh orange juice is not a fruit juice.

While dealing with a Purchase Tax Act, which used the expression “manufactured beverages including fruit-juices and bottled waters and syrups”.

It was held that the description ‘fruit juices’ as occurring therein should be construed in the context of the preceding words and that orange-juice unsweetened and freshly pressed was not within the description.

Doctrine of Contemporanea Expositio

- The maxim “Contemporanea Expositio est optima et fortissima in lege” means “contemporaneous exposition is the best and strongest in the law.”
- This means a law should be understood in the sense in which it was understood at the time when it was passed.
- The maxim “optima legum interpres est consuetudo” simply means, “Custom is the best interpreter of law”.
- But remember that this maxim is to be applied for construing ancient statutes, but not to Acts that are comparatively modern.

Internal aids to interpretation/construction

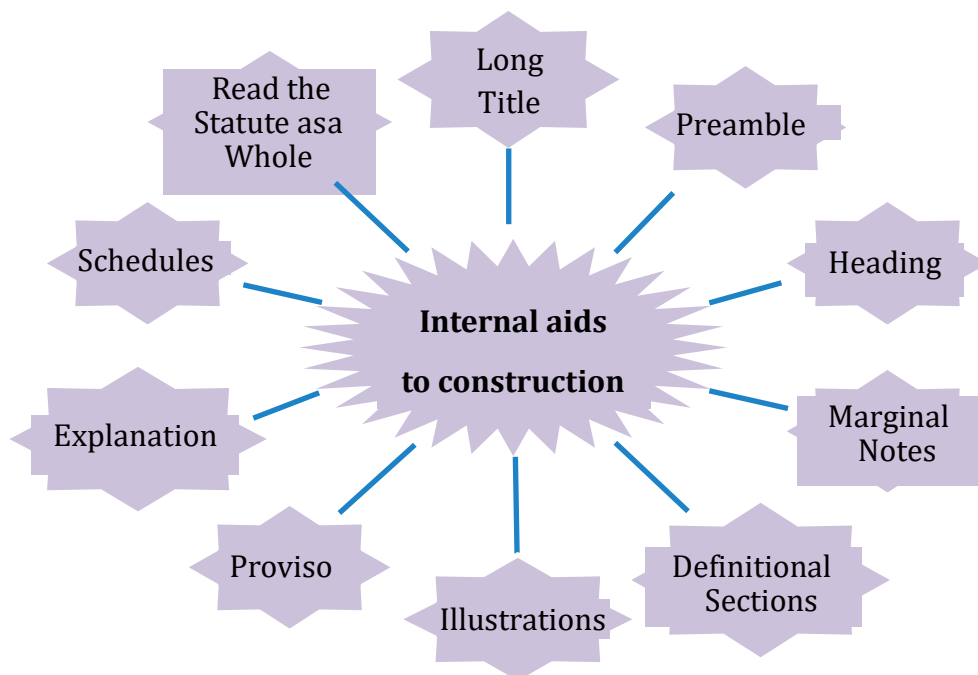

Long Title

Difference between Short Title and Long Title –

1. An enactment would have what is known as a ‘Short Title’ and also a ‘Long Title’.
2. The ‘Short Title’ only identifies the enactment and is chosen merely for convenience, the ‘Long Title’ on the other hand, describes the enactment and does not only identify it.

Example of Long Title : Full title of the Supreme Court Advocates (Practice in High Courts) Act, 1951 specify that this is an Act to authorize Advocates of the Supreme Court to practice as of right in any High Court.

Example of Short Title :- The Companies Act, 2013

Common Points :-

Long Title is a part of the Enactment.

But if the wording of the statute gives rise to doubts as to its proper construction, we can refer to Long Title for interpretation

Long Title cannot override the clear meaning of the enactment.

Preamble

- Meaning - The Preamble expresses the scope, object and purpose of the Act more comprehensively than the Long Title.

Common Points :-

- Preamble is a part of the Enactment.
- But if the wording of the statute gives rise to doubts as to its proper construction, we can refer to Preamble for interpretation
- Preamble cannot override the clear meaning of the enactment.

Example : Use of the word ‘may’ in section 5 of the Hindu Marriage Act, 1955 provides that “a marriage may be solemnized between two Hindus.....” has been construed to be mandatory in the sense that both parties to the marriage must be Hindus as defined in section 2 of the Act. It was held that a marriage between a Christian male and a Hindu female solemnized under the Hindu Marriage Act was void. This result was reached also having regard to the preamble of the Act which reads: ‘An Act to amend and codify the law relating to marriage among Hindus

Heading and title of a chapter

Meaning :- If we go through through any Act, we would generally find that a number of its sections referring to a particular subject are grouped together, sometimes in the form of chapters, prefixed by headings and/or Titles.

Common Points :-

- Heading of a chapters is a part of the Enactment.
- But if the wording of the statute gives rise to doubts as to its proper construction, We can refer to Heading and title of a chapter for interpretation
- Heading of a chapter cannot override the clear meaning of the enactment.

Marginal Notes

- Marginal notes are side notes often found at the side of a section or group of sections in an Act
- They are not a part of the enactment, for they were not present when the Act was passed in Parliament but inserted after the Act has been so passed. Hence, they are not an aid to construction.
- However, marginal notes appended to Articles of the Constitution have been held to be part of the Constitution as passed by the Constituent Assembly and therefore have been used in construing the Articles.
- Contradictory views :- In one of the case law, it has been held that “Marginal notes in an Indian statute, as in an Act, of Parliament cannot be referred to for the purpose of construing the statute”, and the same view has been taken in many other cases. Many cases show that reference to marginal notes may be permissible in exceptional cases for construing a section in a statute.

Definitional Section/Interpretation Clauses

It is quite common to find in the Statutes ‘definitions’ of certain words and expressions used in the body of the statute.

The purpose of a definition clause is two-fold:

- (i) to provide a key to the proper interpretation of the enactment, and
- (ii) to shorten the language of the enacting part by avoiding repetition of the same words contained in the definition part every time the legislature wants to refer to the expressions contained in the definition.

Restrictive and extensive definitions

The definition of a word or expression in the definition section may either be restricting of its ordinary meaning or may be extensive of the same.

When a word is defined to ‘mean’ such and such, the definition is ‘prima facie’ restrictive and exhaustive we must restrict the meaning of the word to that given in the definition section.

But where the word is defined to ‘include’ such and such, the definition is ‘prima facie’ extensive: word defined has extensive meaning which also includes the meaning assigned to it in the definition section.

We may also find a word being defined as ‘means and includes’ such and such. In this case, the definition would be exhaustive.

On the other hand, if the word is defined ‘to apply to and include’, the definition is understood as extensive.

Ambiguous definitions

Sometime, we may find that the definition section may itself be ambiguous, and so it may have to be interpreted in the light of the other provisions of the Act and having regard to the ordinary meaning of the word defined.

Such type of definition is not to be read in isolation.

It must be read in the context of the phrase which it defines, realising that the function of a definition is to give accuracy and certainty to a word or phrase which would otherwise be vague and uncertain but not to contradict it or depose it altogether.

Internal aids to interpretation/construction

Example : Termination of service of a seasonal worker after the work was over does not amount to retrenchment as per the Industrial Disputes Act, 1947.

Example : But the termination of employment of a daily wager who is engaged in a project, on completion of the project will amount to retrenchment if the worker had not been told when employed that his employment will end on completion of the project.

Internal aids to interpretation/construction

Definitions subject to a contrary context: When a word is defined to bear a number of inclusive meanings, the sense in which the word is used in a particular provision must be ascertained from the context of the scheme of the Act, the language of the provision and the object intended to be served thereby.

Illustrations

- We would find that many sections have illustrations appended(attached) to them.
- These illustrations are given after the text of the Sections and, therefore, do not form a part of the Sections.
- Illustrations cannot have the effect of modifying the language of the section
- Illustration can neither curtail nor expand the ambit of the section.

Common Points:-

- Illustrations given in the Act is a part of the Enactment.
- Illustrations cannot override the clear meaning of the enactment.

Proviso

1. Proviso that are so included begin with the words, “provided that”.
2. The normal function of a proviso is to except something out of the enactment or to qualify something stated in the enactment which would be within its purview if the proviso were not there.
3. Usually, a proviso is embedded in the main body of the section and becomes an integral part of it.
4. As a general rule, a proviso is added to an enactment to qualify or create an exception to what is in the enactment.

5. It carves out an exception to the main provision to which it has been enacted as a proviso and to no other.

Proviso v/s Exception clause v/s Saving Clause

| Distinction between Proviso, exception and saving Clause | | |
|---|---|--|
| 'Exception' is intended to restrain the enacting clause to particular cases | 'Proviso' is used to remove special cases from general enactment and provide for them specially | 'Saving clause' is used to preserve from destruction certain rights, remedies or privileges already existing |

Explanation

An Explanation appended to a section to explain the meaning of certain words. An Explanation may be added to include something within the section or to exclude something from it. **It should not be so construed as to widen the ambit of the section.**

Explain the meaning and intendment of the Act itself

Clarify any obscurity and vagueness (if any) in the main enactment to make it consistent with the object

Provide an additional support to the object of the Act to make it meaningful and purposeful

Fill up the gap which is relevant for the purpose of the explanation to suppress the mischief and advance the object of the Act

Cannot take away a statutory right

Schedules

- **Schedule must be read together with the Act** for all purposes of construction.
- Schedule often contain details and forms for working out the policy underlying the sections of the statute
- Example – There are 7 Schedules given in the Companies Act, 2013

Common Points :-

- **Schedule is a part of the Enactment.**
- **Schedule cannot override the clear meaning of the enactment.**

'Read the Statute as a Whole'

It is the basic principle that construction of a statute is to be made of all its parts taken together and not of one part only.

The deed must be read as a whole in order to ascertain the true meaning of its several clauses, and the words of each clause should be so interpreted as to bring them into harmony with other provisions – if that interpretation does no violence to the meaning of which they are naturally susceptible.

And the same approach would apply with equal force with regard to Acts and Rules passed by the legislature.

Example : If one section of an Act requires 'notice' should be given, then a verbal notice would generally be sufficient. But, if another section provides that 'notice' should be 'served' on the person or 'left' with him, or in a particular manner or place, then it would obviously indicate that a written notice was intended.

External aids to interpretation/construction

Apart from the statute itself there are many matters which may be taken into account when the statute is ambiguous. These matters are called external aids. Some of these factors are enumerated below:

| External Aids | | | | | |
|--------------------|---------------------------------------|-------|---|------------------------|--------------------------|
| Historical Setting | Consolidating Statutes & Previous Law | Usage | Earlier & Later Acts and Analogous Acts | Dictionary Definitions | Use of Foreign Decisions |

External aids to interpretation/construction

Historical Setting:

The **history of the external circumstances which led to the enactment in question is of much significance in interpreting any enactment.**

For interpretation, **we need to take help from all those external or historical facts which are necessary in the understanding and comprehension of the subject matter and the scope and object of the enactment.**

History in general and Parliamentary History in particular all are relevant in interpreting and construing an Act.

We have also to consider **whether the statute in question was intended to alter the law or leave it where it stood before.**

Consolidating Statutes & Previous Law

The Preambles to many Statutes contain expressions such as “An Act to consolidate” the previous law, etc.

In such a case, the Courts may stick to the presumption that it is not intended to alter the law but to consolidate the earlier law only.

They may solve doubtful points in the statute with the aid of such presumption in intention, rejecting the literal construction.

Usage

- Usage is also sometimes taken into consideration in construing an Act.
- The acts done under a statute provide quite often the key to the statute itself.
- It is well known that where the meaning of the language in a statute is doubtful, usage – how that language has been interpreted and acted upon over a long period – may determine its true meaning.
- For several years, when a legislative measure of doubtful meaning has, received an interpretation which has generally been acted upon by the public, the Courts should be very unwilling to change that interpretation, unless they see reasons for doing so.

Exposition of One Act by Language of Another

The general principle is that where there are different Statutes in ‘pari materia’ (i.e. in an analogous case), though made at different times, or even expired and not referring to each other, they shall be taken and construed together as one system and as explanatory of each other.

If two Acts are to be read together then every part of each Act has to be construed as if contained in one composite Act.

However, this does not mean that every word in the later Act is to be interpreted in the same way as in the earlier Act.

Earlier Act Explained by the Later Act

Not only may the later Act be construed in the light of the earlier Act but it (the later Act) sometimes furnishes a legislative interpretation of the earlier one, if it is ‘pari materia’ and if, but only if, the provisions of the earlier Act are ambiguous.

Where the earlier statute contained a negative provision but the later one merely omits that negative provision. This cannot by itself have the result of substantive affirmation. In such a situation, it would be necessary to see how the law would have stood without the original provision and the terms in which the repealed sections are re-enacted **pari materia means when two provisions of two different statutes deal with the same subject matter and form part of the same subject matter.**

Reference to Repealed Act

Where a part of an Act has been repealed, it loses its operative force. Nevertheless, such a repealed part of the Act may still be taken into account for construing the un-repealed part. This is so because it is part of the history of the new Act.

Dictionary Definitions

- First we have to refer to the Act in question to find out if any particular word or expression is defined in Act itself.
- If word is not defined in the Act itself, we may refer to dictionaries to find out the general sense in which that word is commonly understood.
- However, Dictionaries contain multiple meaning of the same word, then in selecting one out of the several meanings of a word, we must always take into consideration the context in which it is used in the Act.
- It is the fundamental rule that the meanings of words and expressions used in an Act must take their colour from the context in which they appear.
- However, for technical terms reference may be made to technical dictionaries.

Use of Foreign Decisions

- Foreign decisions of countries following the same system of jurisprudence as ours and given on laws similar to ours can be legitimately used for construing our own Acts.
- However, prime importance is always to be given to the language of the Indian statute.
- Further, where guidance can be obtained from Indian decisions, reference to foreign decisions may become unnecessary.

Example - Salomon v A Salomon & Co Ltd [1896] UKHL 1, [1897] AC 22

Rules of interpretation/ construction of deeds and documents

- The first and foremost point that has to be borne in mind is that one has to find out what a reasonable man, who has taken care to inform himself of the surrounding circumstances of a deed or a document, and of its scope and intendments, would understand by the words used in that deed or document.
- A deed must be read as a whole in order to ascertain the true meaning of its several clauses and the words of each clause should be so interpreted as to bring them in harmony with other provisions
- The golden rule of construction is to ascertain the intention of the parties to the instrument after considering all the words in their ordinary, natural sense.
- It has to be borne in mind that many words are used in more than one sense and that sense differs in different circumstances.
- It is inexpedient to interpret the terms of one deed by reference to the terms of another.
- It is an basic rule of construction that the same word cannot have two different meanings in the same document, unless the context compels the adoption of such a course
- The document must be read as a whole and the intention deduced therefrom as to what the actual term the parties intended to agree.

- It may also happen that **there is a conflict** between two or more clauses of the same document. An **effort must be made to resolve the conflict** by interpreting the clauses so that all the clauses are given effect to. **If, however, it is not possible** to give effect to all of them, then it is the **earlier clause that will over-ride the latter one**.
- Similarly, **if one part of the document is in conflict with another part**, an attempt should always be made to **read the two parts of the document harmoniously**, if possible. If that is not possible, then the **earlier part will prevail over the latter one** which should, therefore, be disregarded.

THE FOREIGN EXCHANGE MANAGEMENT ACT, 1999

Features of FEMA, 1999

Salient Features of FEMA, 1999: It provides for-

- ◆ Regulation of transactions between residents and non-residents
- ◆ Investments in India by non-residents and overseas investments by Indian residents
- ◆ Freely permissible transactions on current account subject to reasonable restrictions that may be imposed
- ◆ RBI of India (RBI) and CG control over capital account transactions
- ◆ Requirement for realisation of export proceeds and repatriation to India
- ◆ Dealing in foreign exchange through 'APs' like Authorised Dealer/ Money Changer/ Off-shore banking unit
- ◆ Adjudication and Compounding of Offences
- ◆ Investigation of offences by Directorate of Enforcement
- ◆ Appeal provisions including Special Director (Appeals) and Appellate Tribunal.

Preamble, Extent, Application and Commencement

- (A) **Preamble:** This Act aims to consolidate and amend the law relating to foreign exchange with the objective of —
- (i) facilitating external trade and payments and
 - (ii) for promoting the orderly development and maintenance of foreign exchange market in India.
- (B) **Extent and Application [Section 1]:** FEMA, 1999 extends to the whole of India. In addition, it shall also apply to all branches, offices and agencies outside India owned or controlled by a PRI and also to any contravention thereunder committed outside India by any person to whom this Act applies.
- (C) **Commencement:** FEMA, 1999 came into force with effect from 1st June, 2000

Important Definitions

“*Capital Account Transaction*” means a transaction, which alters the assets or liabilities, including contingent liabilities, outside India of persons resident in India or assets or liability in India of persons resident outside India [Section 2(e)]

“*Current Account Transaction*” means a transaction other than a capital account transaction and without prejudice to the generality of the foregoing such transaction includes,

- (i) payments due in connection with foreign trade, other current business, services, and short-term banking and credit facilities in the ordinary course of business.
- (ii) payments due as interest on loans and as net income from investments.
- (iii) remittances for living expenses of parents, spouse and children residing abroad, and
- (iv) expenses in connection with foreign travel, education and medical care of parents, spouse and children; [Section 2(j)]

“*Person Resident in India*” means:

- (i) a person residing in India for more than 182 days during the course of the preceding financial year but does not include—
 - (A) a person who has gone out of India or who stays outside India, in either case-
 - (a) for or on taking up employment outside India, or
 - (b) for carrying on outside India a business or vocation outside India, or
 - (c) for any other purpose, in such circumstances as would indicate his intention to stay outside India for an uncertain period
 - (B) a person who has come to or stays in India, in either case, otherwise than:
 - (a) for or on taking up employment in India, or
 - (b) for carrying on in India a business or vocation in India, or
 - (c) for any other purpose, in such circumstances as would indicate his intention to stay in India for an uncertain period;
 - (ii) any person or body corporate registered or incorporated in India,
 - (iii) an office, branch or agency in India owned or controlled by a PROI,
 - (iv) an office, branch or agency outside India owned or controlled by a PRI; [Section 2(v)]
- “*Person Resident Outside India*” means a person who is not resident in India; [Section 2(w)]

“*Person*” includes:

- (i) an individual,
- (ii) a Hindu undivided family,
- (iii) a company,
- (iv) a firm,
- (v) an association of persons or a body of individuals, whether incorporated or not,
- (vi) every artificial juridical person, not falling within any of the preceding sub-clauses, and;
- (vii) any agency, office or branch owned or controlled by such person; [Section 2(u)]

Other Definitions

“*Currency*” includes all currency notes, postal notes, postal orders, money orders, cheques, drafts, travelers’ cheques, letters of credit, bills of exchange and promissory notes, credit cards or such other similar instruments, as may be notified by the Reserve Bank. [Section 2(h)]

“*Authorised person*” means an authorised dealer, money changer, off-shore banking unit or any other person for the time being authorised under section 10(1) to deal in foreign exchange or foreign securities; [Section 2(c)]

“*Currency Notes*” means and includes cash in the form of coins and bank notes; [Section 2(i)]

“*Export*”, with its grammatical variations and cognate expressions means;

- (i) the taking out of India to a place outside India any goods.
- (ii) provision of services from India to any person outside India; [Section 2(l)]

“*Foreign Currency*” means any currency other than Indian currency; [Section 2(m)]

“*Foreign Exchange*” means foreign currency and includes:

- (i) deposits, credits and balances payable in any foreign currency,

- (ii) drafts, travelers' cheques, letters of credit or bills of exchange, expressed or drawn in Indian currency but payable in any foreign currency,
- (iii) drafts, travelers' cheques, letters of credit or bills of exchange drawn by banks, institutions or persons outside India, but payable in Indian currency; [Section 2(n)]

“*Foreign Security*” means any security, in the form of shares, stocks, bonds, debentures or any other instrument denominated or expressed in foreign currency and includes securities expressed in foreign currency, but where redemption or any form of return such as interest or dividends is payable in Indian currency; [Section 2(o)]

“*Import*”, with its grammatical variations and cognate expressions, means bringing into India any goods or services; [Section 2(p)]

“*Transfer*” includes sale, purchase, exchange, mortgage, pledge, gift, loan or any other form of transfer of right, title, possession or lien. [Section 2(ze)]

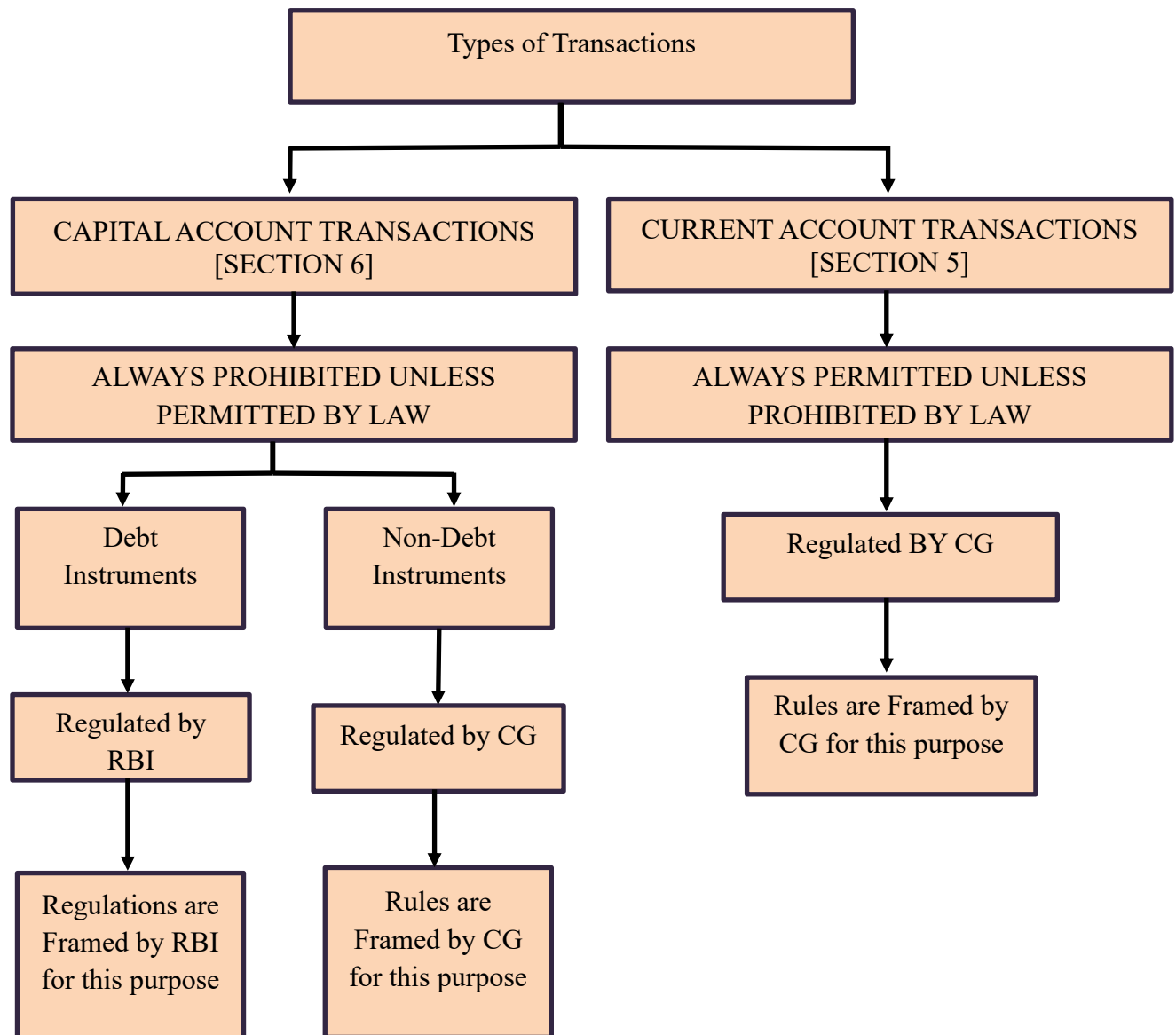

Current Account Transaction [Section 5]

- Section 5 permits any person to sell or draw Foreign Exchange to or from AP to undertake any current account transaction.
- The CG has the power to impose reasonable restrictions, in consultation with the RBI and in public interest on current account transactions.
- The CG has in exercise of this power issued the Foreign Exchange Management (Current Account Transactions) Rules, 2000.
- Current Account Transactions can be divided into following categories:-
 - Prohibited Current Account Transactions – Schedule I
 - Transactions require prior approval of CG – Schedule II
 - Transactions require prior approval of RBI – Schedule III
 - Any other transactions not covered above can be freely undertaken

Prohibited Current Account Transactions [Schedule I]

Transactions for which drawal of foreign exchange is prohibited:

- (i) Remittance out of lottery winnings
- (ii) Remittance of income from racing/riding, etc., or any other hobby.
- (iii) Remittance for purchase of lottery tickets, banned/prescribed magazines, football pools, sweepstakes etc.
- (iv) Payment of commission on exports made towards equity investment in Joint Ventures/Wholly Owned Subsidiaries abroad of Indian companies.
- (v) Remittance of dividend by any company to which the requirement of dividend balancing is applicable.
- (vi) Payment of commission on exports under Rupee State Credit Route, except commission up to 10% of invoice value of exports of tea and tobacco.
- (vii) Payment related to “Call Back Services” of telephones.
- (viii) Remittance of interest income on funds held in Non-resident Special Rupee Scheme a/c.

Transactions require prior approval of CG [Schedule II]

| Purpose of Remittance | Ministry/Department of Govt. of India whose approval is required |
|--|---|
| Cultural Tours | Ministry of Human Resources Development (Department of Education and Culture) |
| Advertisement in foreign print media by State government and its Public Sector Undertakings exceeding US\$ 10,000 Exception – No restriction if for promotion of tourism, foreign investments and international bidding | Ministry of Finance, Department of Economic Affairs |

| | |
|---|---|
| Remittance of freight of vessel chartered by a PSU | Ministry of Surface Transport (Chartering Wing) |
| Payment of import through ocean transport by a Govt. Department or a PSU on c.i.f. basis (i.e., other than f.o.b. and f.a.s. basis) | Ministry of Surface Transport (Chartering Wing) |
| Multi-modal transport operators making remittance to their agents abroad | Registration Certificate from the Director General of Shipping |
| Remittance of hiring charges of transponders by (a) TV Channels (b) Internet service providers | Ministry of Information and Broadcasting Ministry of Communication and Information Technology. |
| Remittance of container detention charges exceeding the rate prescribed by Director General of Shipping | Ministry of Surface Transport (Director General of Shipping) |
| Remittance of prize money/ sponsorship of sports activity abroad by a person other than International/ National/State Level sports bodies, if the amount involved exceeds US \$ 100,000 | Ministry of Human Resource Development (Department of Youth Affairs and Sports) |
| Remittance for membership of P & I Club | Ministry of Finance (Insurance Division) |

Schedule III – Transactions require prior approval of RBI

1. **Facilities for individuals**—Individuals can avail foreign exchange facility for the following purposes within the limit of USD 250,000 only. Beyond limit requires RBI approval:
 - i. Private visits to any country (except Nepal and Bhutan)
 - ii. Gift or donation
 - iii. Going abroad for employment
 - iv. Emigration
 - v. Maintenance of close relatives abroad
 - vi. Travel for business or attending a conference or specialised training or for meeting expenses for meeting medical expenses, or check-up abroad, or for accompanying as attendant to a patient going abroad for medical treatment/ check-up.
 - vii. Expenses in connection with medical treatment abroad
 - viii. Studies abroad
 - ix. Any other current account transaction

However, for the purposes mentioned at item numbers (iv)-Emigration, (vii)-Medical Treatment abroad and (viii)-Studies abroad, the individual may avail of exchange facility for an amount in excess of limit of USD 2500000 prescribed under the LRS if it is so required by a country of emigration, medical institute offering treatment or the university, respectively:

For person who is resident but not permanently resident in India and-

- (a) is a citizen of a foreign State other than Pakistan; or
- (b) is a citizen of India, who is on deputation to the office or branch of a foreign company or subsidiary or joint venture in India of such foreign company,

may make remittance up to his net salary (after deduction of taxes, contribution to provident fund and other deductions).

Explanation: For the purpose of this item, a PRI on account of his employment or deputation of a specified duration (irrespective of length thereof) or for a specific job or assignments, the duration of which does not exceed three years, is a resident but not permanently resident

2. Remittances by persons other than individuals shall require prior approval of RBI:

| | |
|---|--|
| <p>Donations for-</p> <ul style="list-style-type: none"> (a) creation of Chairs in reputed educational institutes, (b) contribution to funds (not being an investment fund) promoted by educational institutes; and (c) contribution to a technical institution or body or association in the field of activity of the donor Company. | <p>exceeding</p> <ul style="list-style-type: none"> • 1 % of their foreign exchange earnings during the previous 3 FYs or • USD 5,000,000, whichever is LESS |
| <p>Commission, per transaction, to agents abroad for sale of residential flats or commercial plots in India</p> | <p>exceeding</p> <ul style="list-style-type: none"> • USD 25,000 or • 5% of the inward remittance whichever is MORE |
| <p>Remittances</p> <ul style="list-style-type: none"> • for any consultancy services in respect of infrastructure projects • for other consultancy services procured from outside India. | <ul style="list-style-type: none"> • exceeding USD 1,00,00,000 per project • exceeding USD 10,00,000 per project |
| <p>Remittances by an entity in India by way of reimbursement of pre-incorporation expenses.</p> | <p>exceeding</p> <ul style="list-style-type: none"> • 5 % of investment brought into India or • USD 1,00,000 whichever is MORE |

Exemption from approval

| | |
|---|---|
| Remittance from Resident Foreign Currency (RFC) A/C | No approval from CG or RBI is required for any remittance out of RFC Account |
| Remittance from Exchange Earners' Foreign Currency (EEFC) A/C | No approval from CG or RBI is required for any remittance out of EEFC A/C except for following transactions: - <ul style="list-style-type: none"> ● Remittance for membership of P & I Club. ● Commission, per transaction, to agents abroad for sale of residential flats or commercial plots in India exceeding USD 25,000 or 5 % of the inward remittance whichever is more ● Remittances exceeding 5 % of investment brought into India or USD 100,000 whichever is More, by an entity in India by way of reimbursement of pre-incorporation expenses. |
| International Credit Card | If a person is on a visit abroad , he can incur expenditure stated in Schedule III if he incurs it through international credit card. |

Capital Account Transactions

1. Capital Account Transactions can be divided into following categories:-
 - Capital Account transactions on which restrictions cannot be imposed
 - Permissible Capital Account Transactions by PRI – Schedule I
 - Permissible Capital Account Transactions by PROI - Schedule II
 - Capital Account transactions which are prohibited
2. A PRI may
 - hold, own, transfer or invest in foreign currency, foreign security or any immovable property situated outside India
 - if such currency, security or property was acquired, held or owned by such person when he was resident outside India or
 - inherited from a person who was resident outside India.

The RBI vide A.P. (DIR Series) Circular No. 90 dated 9th January, 2014 has issued a clarification on section 6(4) of the Act. This covers the following transactions:

- (i) **Foreign currency accounts** opened and maintained by such a person when he was resident outside India;
- (ii) **Income earned through employment or business or vocation outside India** taken up or commenced which such person was resident outside India, or from investments made while such person was resident outside India, or from gift or inheritance received while such a person was resident outside India;

- (iii) Foreign exchange including any income arising therefrom, and conversion or replacement or accrual to the same, held outside India by a PRI acquired by way of inheritance from a PROI.
 - (iv) A PRI may freely utilize all their eligible assets abroad as well as income on such assets or sale proceeds thereof received after their return to India for making any payments or to make any fresh investments abroad without approval of RBI, provided the cost of such investments and/or any subsequent payments received therefor are met exclusively out of funds forming part of eligible assets held by them and the transactions is not in contravention to extant FEMA provisions.
3. A PROI may
- hold, own, transfer or invest in Indian currency, security or any immovable property situated in India
 - if such currency, security or property was acquired, held or owned by a such person when he was resident in India or
 - inherited from a person who was resident in India.

Capital Account Transactions with no restrictions

- (1) For **amortization of loan** - restrictions cannot be imposed when drawal is of the purpose of repayments of loan installments.
- (2) For **depreciation of direct investments** in ordinary course of business.

List of permissible Capital Account Transactions made by PRI [Schedule I]

- (a) Investment by a PRI in foreign securities.
- (b) Foreign currency loans raised in India and abroad by a PRI.
- (c) Transfer of immovable property outside India by a PRI.
- (d) Guarantees issued by a PRI in favour of a PROI.
- (e) Export, import and holding of currency/currency notes.
- (f) Loans and overdrafts (borrowings) by a PRI from a PROI.
- (g) Maintenance of foreign currency accounts in India and outside India by a PRI.
- (h) Taking out of insurance policy by a PRI from an insurance company outside India.
- (i) Loans and overdrafts by a PRI to a PROI.
- (j) Remittance outside India of capital assets of a PRI.
- (k) Undertake derivative contracts

Note :- Resident individual may, draw foreign exchange from AP not exceeding USD 2,50,000 per financial year for transactions specified in Schedule I. However, It shall not be remitted to non-cooperative countries.

List of permissible Capital Account Transactions made by PROI [Schedule I]

- (a) Investment in India by a PROI, that is to say,
 - (i) issue of security by a body corporate or an entity in India and investment therein by a PROI; and
 - (ii) investment by way of contribution by a PROI to the capital of a firm or a proprietorship concern or an association of a person in India.
- (b) Acquisition and **transfer of immovable property** in India by a PROI.
- (c) Guarantee by a PROI in favour of, or on behalf of, a PRI.
- (d) **Import and export of currency/currency notes** into/from India by a PROI.
- (e) Deposits between a PRI and a PROI.
- (f) Foreign currency accounts in India of a PROI.
- (g) Remittance outside India of capital assets in India of a PROI.
- (h) Undertake derivative contracts

Prohibited Capital Account Transactions

- (a) PROI is prohibited from making investments in India in any form in
 - (i) Chit fund business (Refer Note 1)
 - (ii) As Nidhi company;
 - (iii) In agricultural or plantation activities;
 - (iv) Real estate business or construction of farms (Refer Note 2)
 - (v) Trading in Transferable Developments Rights (Refer Note 3)

Note

1. Chit Fund business - Registrar of Chits or officer authorised by SG, in consultation with SG, **permit any chit fund to accept subscription from NRIs through banking channel and on non- repatriation basis** without limit subject to the conditions stipulated by the RBI of India from time to time
 2. Term “real estate business” shall **not include development of townships, construction of residential/commercial premises, roads or bridges** and Real Estate Investment Trusts (REITs)
 3. 'Transferable Development Rights' means certificates issued in respect of category of land acquired for public purpose either by CG or SG in consideration of surrender of land by the owner without monetary compensation, which are transferable in part or whole
- (b) **No PRI shall undertake any capital account transaction** which is not permissible with any person who is a citizen of or a resident of Democratic People’s Republic of Korea, or an entity incorporated or otherwise, in Democratic People’s Republic of Korea, **unless approved by CG**
 - (c) **Existing investment transactions**, with any person of Democratic People’s Republic of Korea shall be **liquidated, closed, settled within 180 days** of order **unless approved by CG** [Order dated 21 April 2017]

Liberalised Remittance Scheme (LRS):

Under the LRS, all **resident individuals, including minors**, are allowed to freely remit up to **USD 2,50,000 per financial year** for any **permissible current or capital account** transaction or a combination of both.

In case of remitter being a minor, the LRS declaration form must be **countersigned by the minor's natural guardian**.

The Scheme is **not available to corporates, partnership firms, HUF, Trusts** etc.

Consolidation of remittance of family members - Remittances under the Scheme can be consolidated in respect of family members subject to individual family members complying with its terms and conditions.

Exception: **Clubbing is not permitted** by other family members for **capital account transactions such as opening a bank account/investment/purchase of property**, if they are not the **co-owners/co-partners** of the overseas bank account/ investment/ property.

Dealing in foreign exchange, etc. [Section 3]

Save as otherwise provided, **No person shall-**

| Provision | Example |
|--|---|
| a) deal in or transfer any foreign exchange or foreign security to any person not being an Authorised Person (AP) | A PROI comes to India and would like to sell US\$ 1,000 to his friend who is resident in India. The friend offers him a rate better than the banks. This cannot be done as it would amount to dealing in foreign exchange. |
| b) make any payment to or for the credit of any PROI in any manner; | A PROI has an insurance policy in India. He requests his brother in India to pay the insurance premium. This will amount to payment for the credit of non-resident. This is not permitted. |
| c) receive otherwise than through an AP, any payment by order or on behalf of any PROI in any manner. | A foreign tourist comes to India and he takes food at a restaurant. He would like to pay US\$ 20 in cash to the restaurant. The restaurant cannot accept cash as it will be a receipt otherwise than through AP. The restaurant will have to take a money changers license to accept foreign currency. |
| d) enter into any financial transaction in India as consideration for or in association with acquisition or creation or transfer of a right to acquire, any asset outside India by any person. | Transactions covered by this sub-section are known as Hawala transactions. An Indian resident gives Rs. 70,000 in cash to an Indian dealer. For this transaction, the brother in Dubai will get US\$ 1,000 from a Dubai dealer. The two dealers may settle the transactions later. However, transaction is not permitted. |

❖ **Holding of foreign exchange [Section 4]**

Except as provided in this Act, **no PRI shall acquire, hold, own, possess or transfer any foreign exchange, foreign security or any immovable property situated outside India.**

Example :- If an Indian resident receives bank balance of US\$ 10,000 from his uncle in London, the Indian resident cannot hold on to the foreign funds. He is supposed to bring back the funds as provided in section 8.

Enforcement of FEMA: Though RBI exercises overall control over foreign exchange transactions, **enforcement of FEMA has been entrusted to a separate 'Directorate of Enforcement'** formed for this purpose. [Section 36].

ANSWER WRITING IN LAW PAPER

Format for answering Case Studies

- ◆ Presentation is important in theory exams like Law and Audit.
- ◆ ICAI has not provided any specific format but it is advisable to follow the following format: -
 - ◆ Provisions
 - ◆ Facts /Analysis
 - ◆ Conclusion
- ◆ Underline keywords & conclusion
- ◆ Instead of writing in paragraph, write in pointwise form

Length of Answer

- ◆ Length of answer depends on multiple factors
 - a. Concept asked in question
 - b. Technicality of question
 - c. Marks

Quoting Section number in exams?

While writing answers in law, it is **not mandatory** to write section number but it is advisable to write section number.

NEVER quote wrong section number in your answers. Write section number only when you are 100 percent sure about the accuracy.

Own Language or ICAI Module Language

It is humanly not possible for a student to learn ICAI whole module word by word.

Therefore, student can frame the answers in their own language but **using keywords of law in your answers is must.**

List of Forms under the Companies Act, 2013

Forms under the Companies Act along with the relevant description has been given below for quick and a better understanding.

| Form Number | Description |
|-------------|--|
| INC 1 | Application for reservation of name |
| INC 3 | Consent of Nominee as regards One Person Company |
| INC 4 | Change of nominee as regards One Person Company |
| INC 8 | Declaration by an Advocate, Chartered Accountant, Cost Accountant or Company Secretary in practice that all requirements of the companies act and rules pertaining to incorporation have been complied with |
| INC 9 | Declaration by each of the subscribers to the memorandum and each of the first directors named in the articles that he has not been convicted of any offence for the preceding 5 years and that all the documents filed with the Registrar are true and accurate. |
| INC 11 | Certificate of Incorporation |
| INC 13 | Memorandum of Association |
| INC 14 | Declaration by an Advocate, a Chartered Accountant, Cost Accountant or Company Secretary in practice, that the articles of association have been drawn up in conformity with the provisions of Section 8 and rules made thereunder and that all the requirements concerning the Act and the rules made thereunder in relation to registration of the company under Section 8 and matters incidental or supplemental thereto have been complied with. |
| INC 15 | Declaration by each of the persons making the application (Section 8 companies) |
| INC 18 | Application to Regional Director for conversion of section 8 company into company of any other kind |
| INC 19 | Notice in case of conversion of section 8 Co. |
| INC 20A | Declaration of commencement of business |
| INC 22 | Notice for change of situation of the registered office of the company and its verification |

| | |
|---------------|--|
| INC 23 | Application to Regional Director for approval to shift the Registered Office |
| INC 24 | Application to the Central Government for approval for change in the name of the company |
| INC 25 | A new certificate of incorporation subsequent to change in name |
| INC 26 | Advertisement to be published in newspaper for change in the registered office from one State Government or Union territory to another |
| INC 28 | Notice of the order of the court/any other competent authority |
| INC 32 | Simplified Proforma for Incorporating Company electronically plus (SPICe+) |
| INC 33 | e-Memorandum of association |
| INC 34 | e-Articles of association |
| RD 1 | Application to the regional director for change in a financial year or the conversion of a public company into a private company |
| PAS-1 | Notice of Advertisement under section 27 |
| PAS-2 | Information Memorandum |
| PAS-3 | Return of Allotment |
| PAS-4 | Private Placement Offer Cum Application letter |
| PAS-5 | Record of Private Placement Offers |
| SH 4 | Instrument of Transfer |
| SH 5 | Notice for transfer of partly paid securities |
| SH 7 | Notice to Registrar of any alteration of share capital |
| SH 9 | Declaration of Solvency |
| SH 12 | Debenture Trust Deed |
| DPT 1 | Circular or Advertisement of Circular |

| | |
|---------------|---|
| DPT 2 | Deposit Trust Deed |
| DPT 3 | Return of deposits |
| DPT 4 | Statement on existing deposits as on the date of commencement of the companies act |
| CHG 1 | Application to register the creation or modification of charge (other than debentures) |
| CHG 2 | Certificate of registration of charge |
| CHG 3 | Certificate of modification of charge |
| CHG 4 | Intimation regarding satisfaction of charge |
| CHG 5 | Certificate of registration of Satisfaction |
| CHG 6 | Notice for appointment or cessation |
| CHG 7 | Register of Charges |
| CHG 8 | Application to CG under section 87 |
| CHG 9 | Application to register the creation or modification of charge for debentures |
| MGT 1 | Register of members of the company |
| MGT 2 | Register of Debenture Holders or Any Other Security Holders |
| MGT 3 | Notice or the change in the situation or discontinuation of a location where a foreign register is kept |
| MGT 4 | Declaration by registered holder |
| MGT 5 | Declaration by Beneficial Owner |
| MGT 6 | Declaration by Co. with RoC |
| MGT 7 | Annual return of Co. except OPC and Small Co. |
| MGT 7A | Annual Return of OPC and Small Co. |
| MGT 11 | Appointment of proxy for a meeting |

| | |
|------------------------------|---|
| MGT 12 | Polling paper in the meeting |
| MGT 13 | Scrutinizer's report to the Chairman pertaining to the poll of the meeting |
| MGT 14 | Filing of company resolutions and agreements with the Registrar |
| MGT 15 | Form for filing report on the Annual General meeting |
| BEN 1 | Declaration by the significant beneficial owner in case of an individual |
| BEN 2 | Return with Registrar for declaration of SBO |
| BEN 3 | Register of significant beneficial owners |
| BEN 4 | Notice by Co. to SBO or person having knowledge of SBO |
| AOC 1 | Statement containing salient features of financial statements of subsidiaries/ associates/joint ventures |
| AOC 2 | Details containing contracts or arrangements entered into with related parties |
| AOC 3 | Statement containing salient features of the audited financial statements |
| AOC 3A | Detailed statement on the financial statements to be filed by companies complying with the Companies (Indian Accounting Standards) Rules 2015 |
| AOC 4 | Form to file a financial statement and other documents of the company with the Registrar |
| AOC 4 (XBRL) | XBRL document in respect of financial statement and other documents to be filed with the Registrar |
| AOC 4 CFS | Form to file consolidated financial statements and other documents with the Registrar |
| AOC 4 NBFC Ind AS | Form for NBFCs to file financial statement and other documents with the Registrar |
| AOC 4 CFS NBFC IND AS | Form for NBFCs to file consolidated financial statements and other documents with the Registrar |
| AOC 5 | Notice to declare the address of the location in which the books of accounts are maintained |

| | |
|--------------|--|
| ADT 1 | Form to inform the Registrar regarding the appointment of auditor by the company |
| ADT 2 | Application for removing the auditor before the expiry of their term by the company |
| ADT 3 | Notice of resignation by auditor |
| ADT 4 | Form to report any suspected fraud by the auditor to the Central Government |
| CRA 1 | Manner in which Cost records are maintained |
| CRA 2 | Form for intimation of appointment of cost auditor by the company to Central Government |
| CRA 3 | Format of the cost audit report |
| CRA 4 | Form for filing cost audit report with the Central Government |
| FC 1 | Information to be filed by foreign company |
| FC 2 | Return of alteration in the documents filed for a foreign company registration |
| FC 3 | Annual accounts and the list of all principal places of business established in India by a foreign company |
| FC 4 | Annual Return of a Foreign company |

**BHARAT'S BEST AND MOST AFFORDABLE
CA EDUCATION PLATFORM
VISHWAS CA**

ABOUT AUTHOR

- > *Cleared All 3 Levels Of Ca In 1st Attempt*
- > *In Ca Inter : Secured All India Rank 23rd
(1st In Maharashtra State)*
- > *Ca Final : Secured All India Rank 25th*
- > *Scored 92% In 12th Std From Cbse Board : 90+
In Maths, Accounts & Business Studies*
- > *Ex-grade A Officer In Psu : Indian Oil Corporation
Limited (a Global Fortune 500 Company)*
- > *Taught 50,000+ Ca Students*
- > *Speciality : Teaches Subjects Practically From The
Basic Level And In A Fun Manner*

- CA GURPREET SINGH



RAHUL BHUTANI SIR

CA RISHABH ROHRA

DEEPAK GUSAIN SIR

CA GURPREET SINGH

CA JYOTI DESHWAL

CA MANISHA TEJWANI KABRA



SCAN QR TO JOIN OUR
WHATSAPP CHANNEL



SCAN QR TO JOIN OUR
TELEGRAM CHANNEL



SCAN QR TO JOIN OUR
YOUTUBE CHANNEL

FOR MORE INFO : +91 8273962323 | +91 8273852323

#VISHWAS_KARO_HUM_SAMBHAL_LENGE