

Sec 3 Formation of a company.

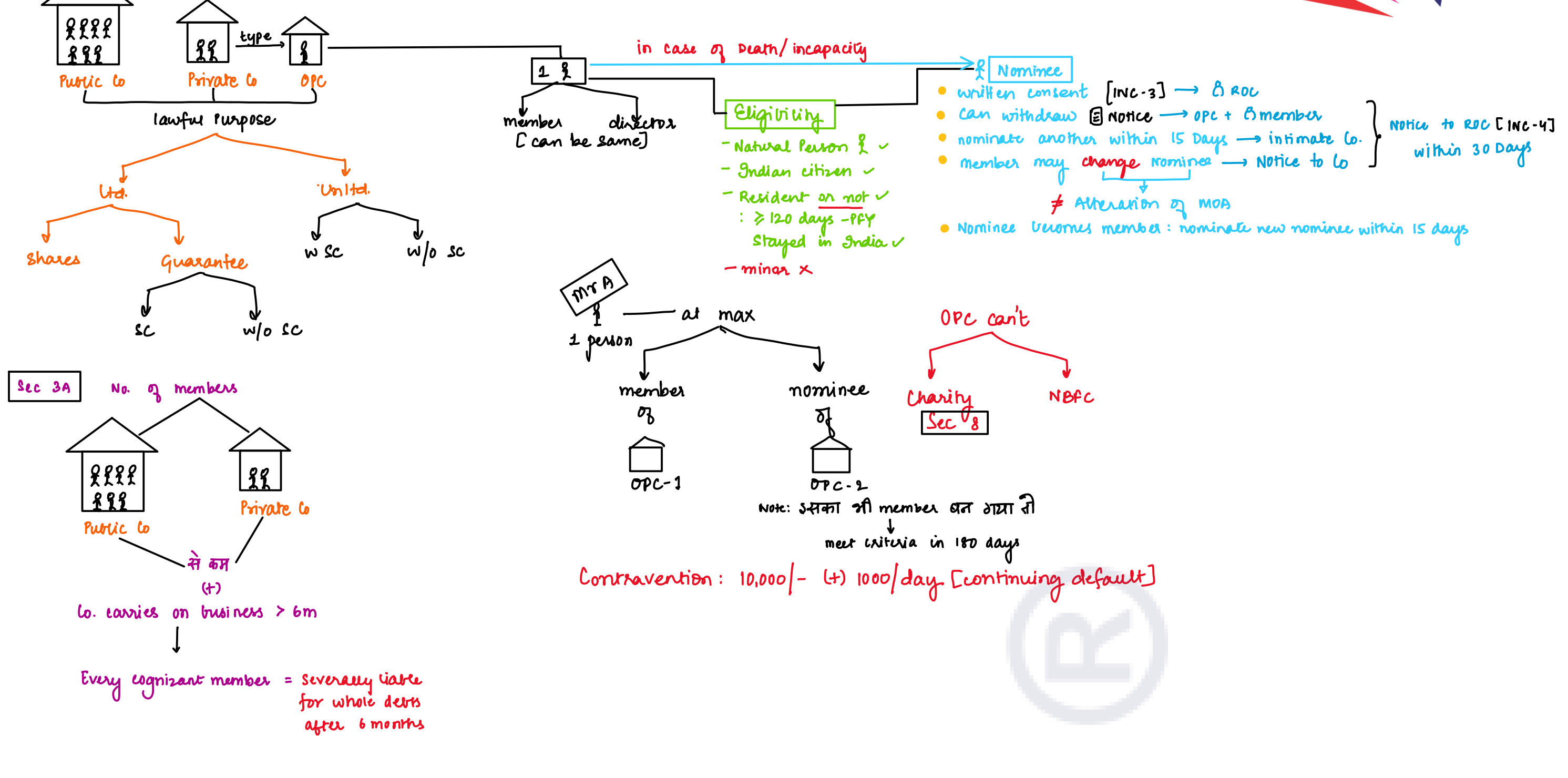

STEPS FOR INCORPORATION

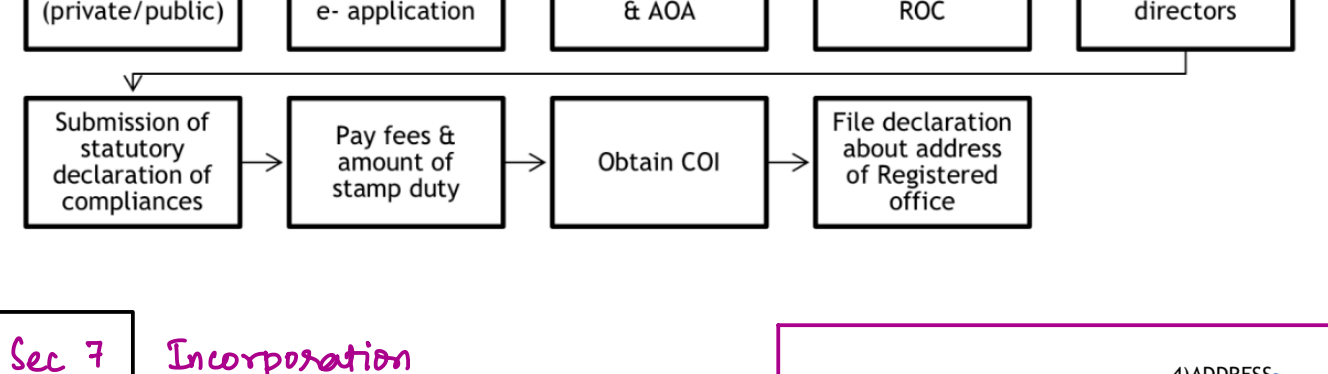

Sec 7 Incorporation

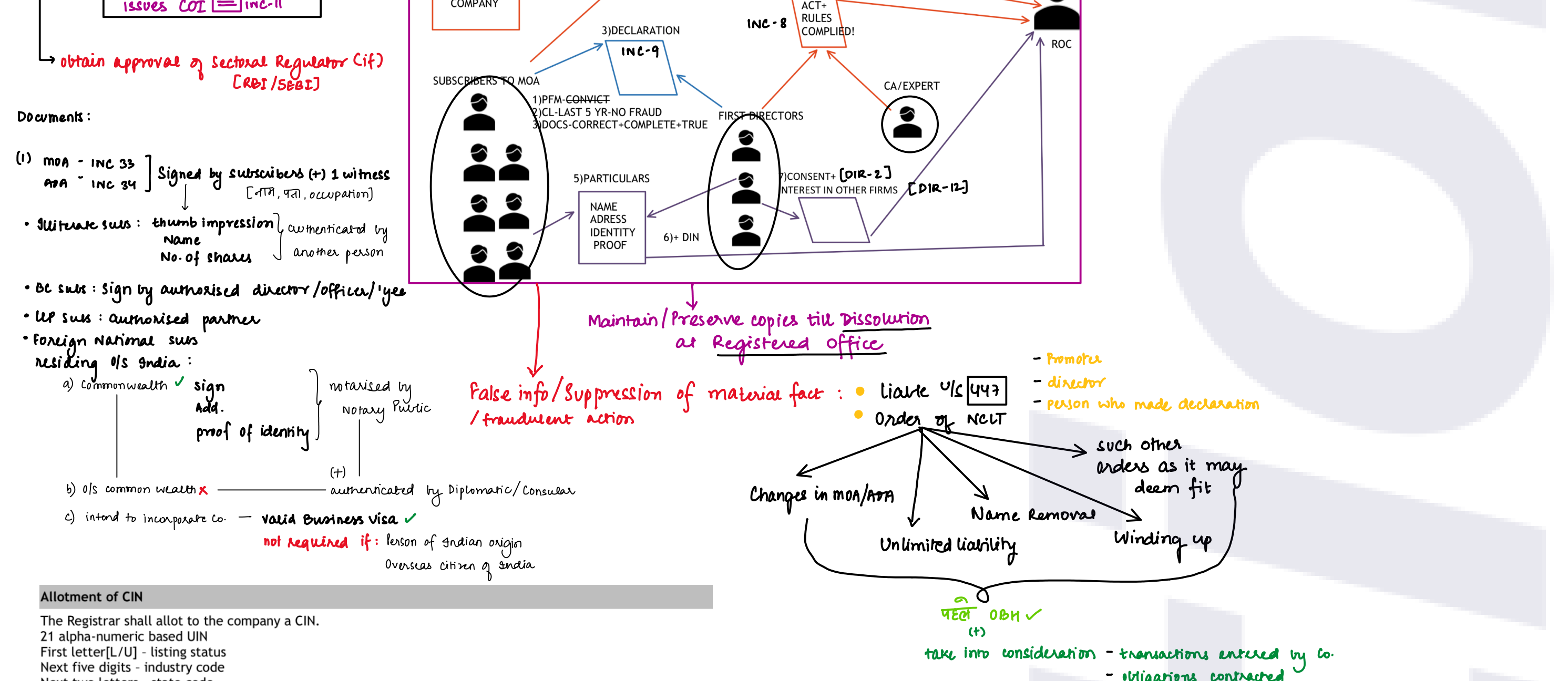

Alignment of CIN

The Registrar shall allow the company a CIN. CIN is a unique alphanumeric code assigned to every company.

Sec 4 Memorandum of Association

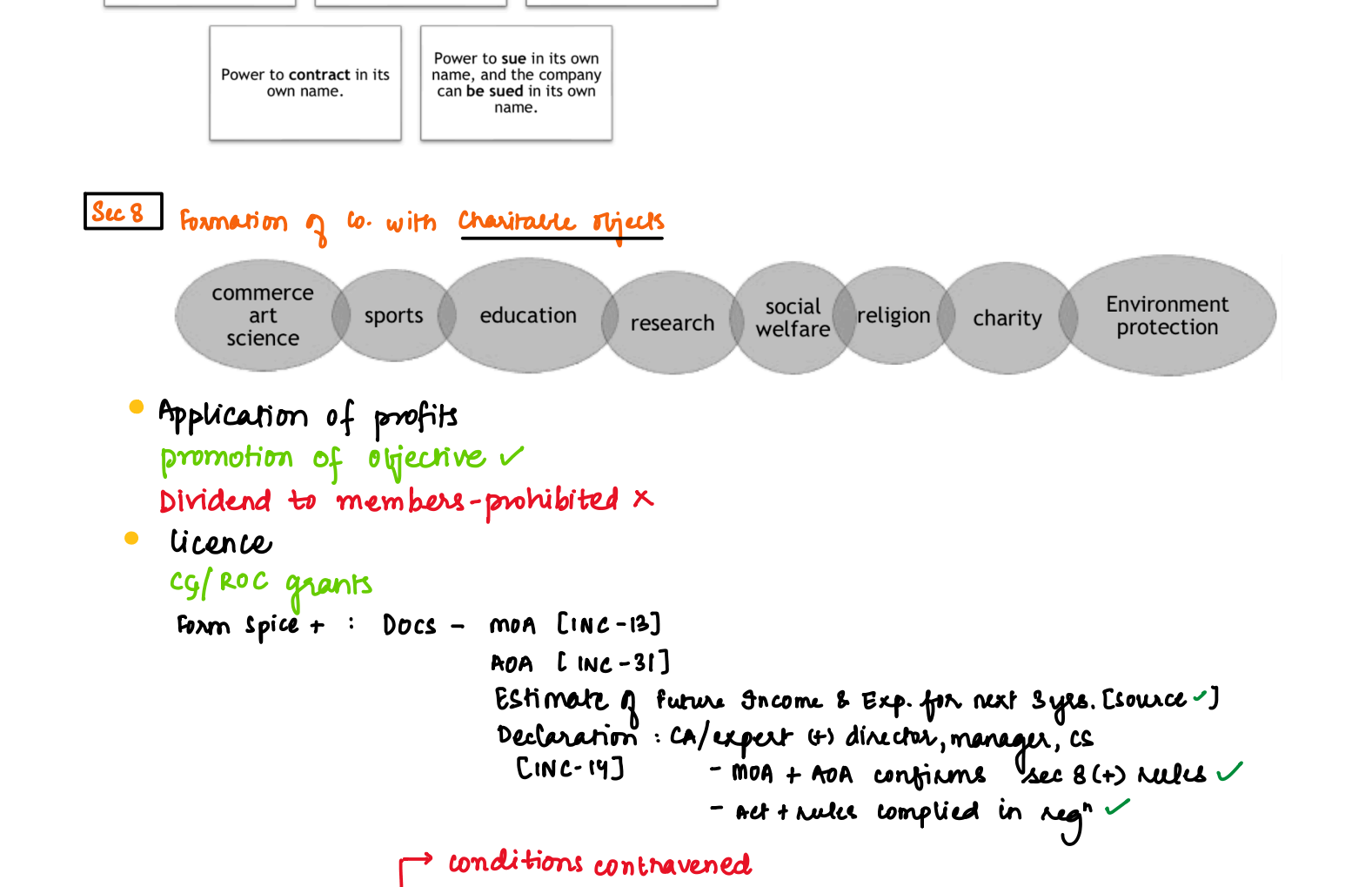

Sec 5 Articles of Association

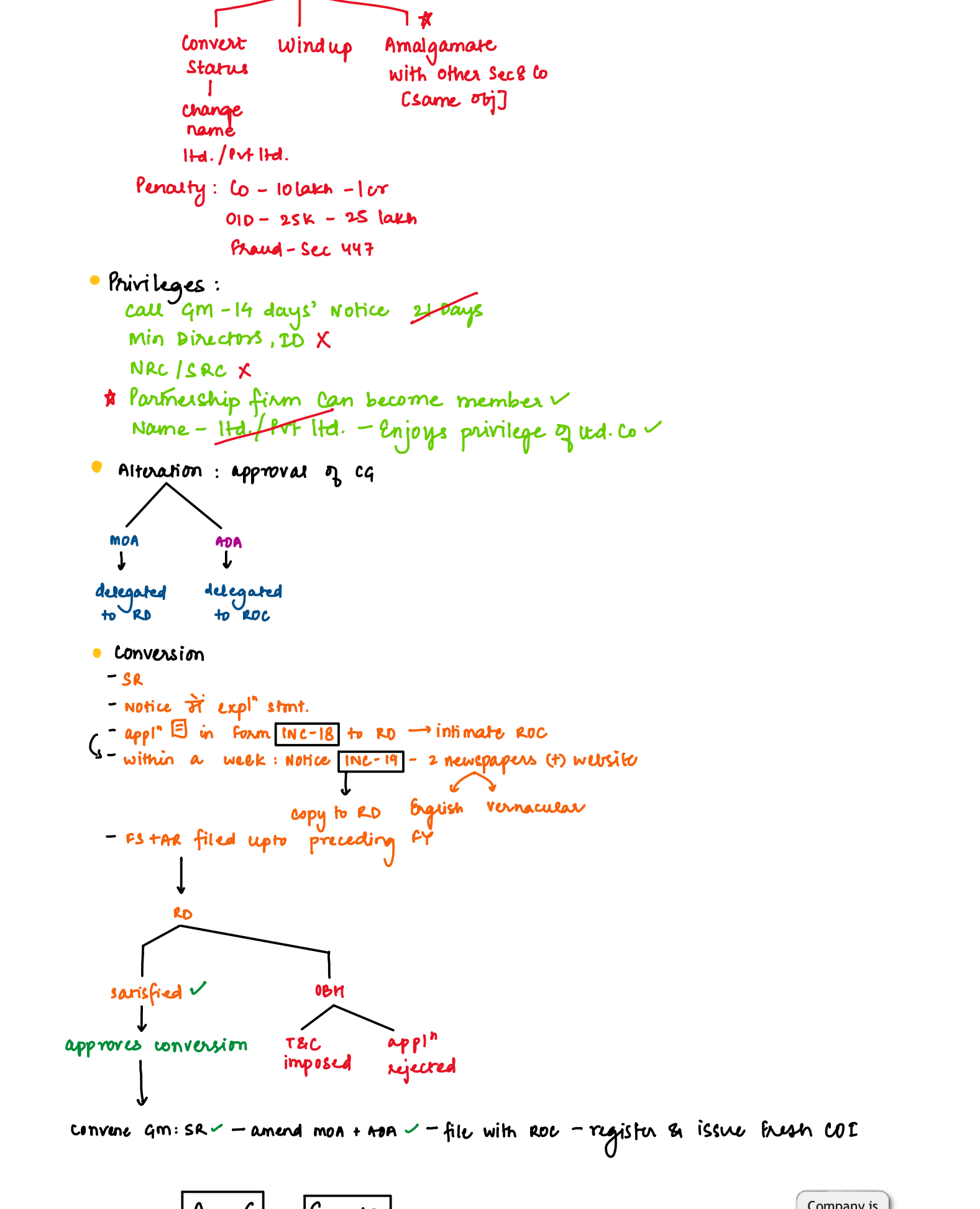

Sec 6 Director

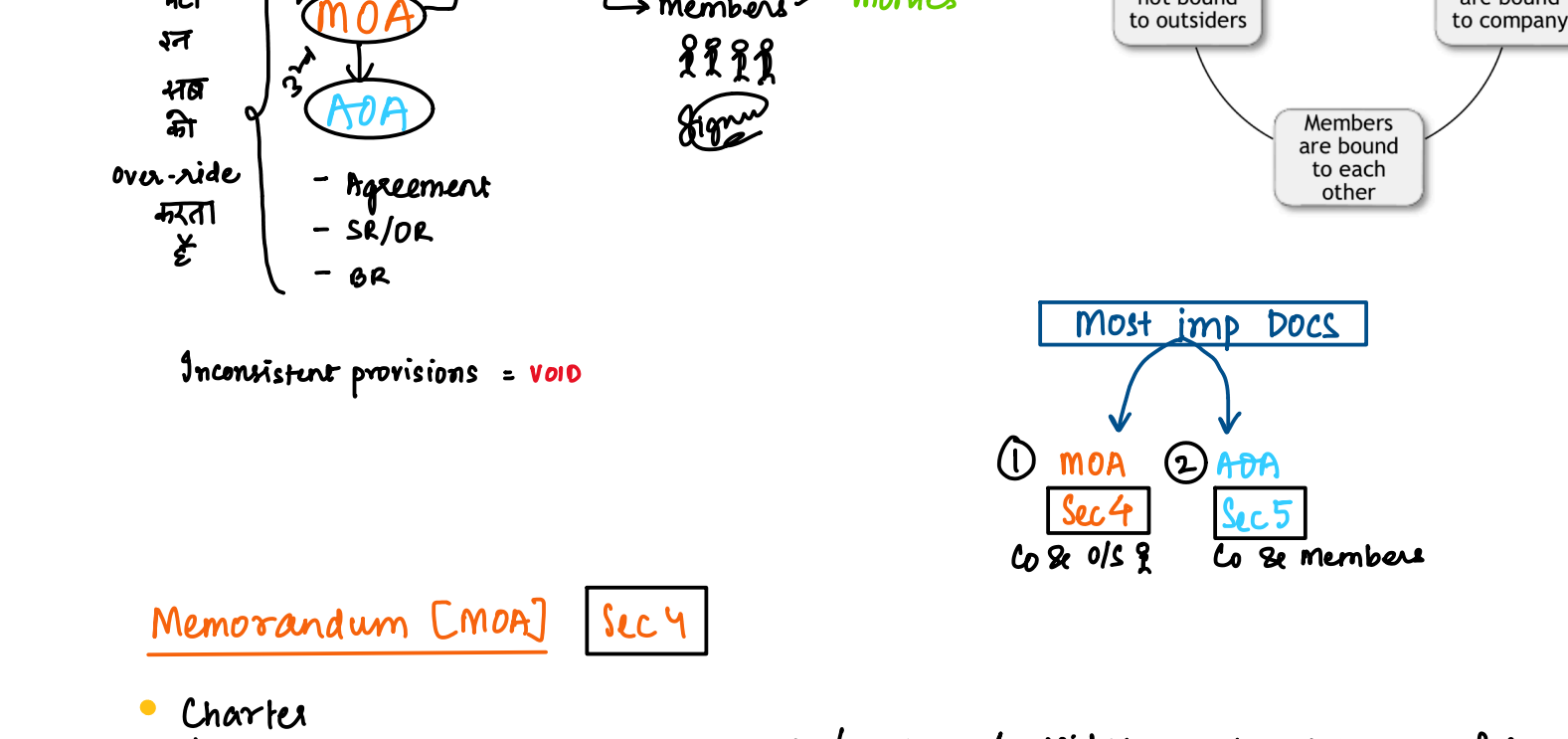

Sec 7 Share

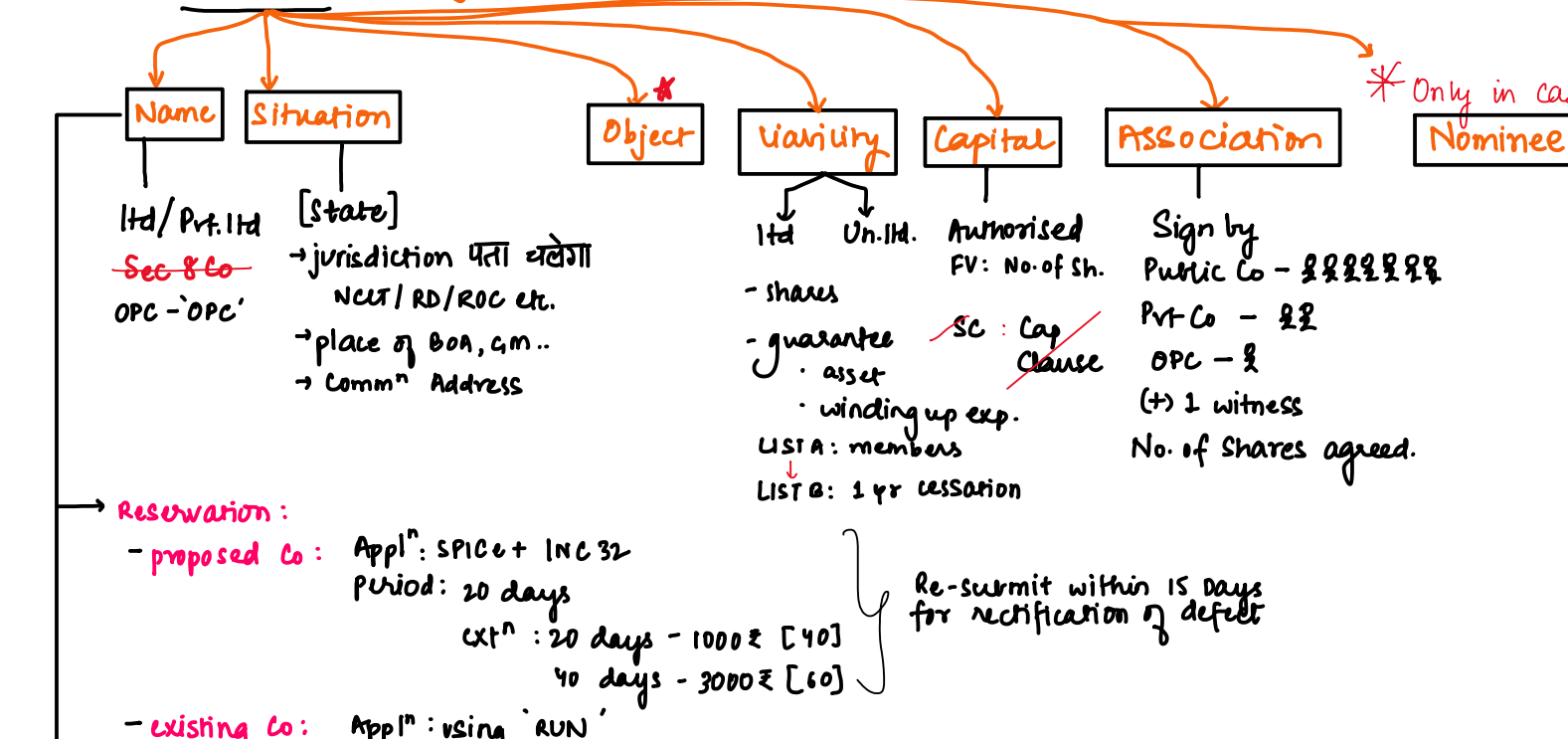

Sec 8 Capital

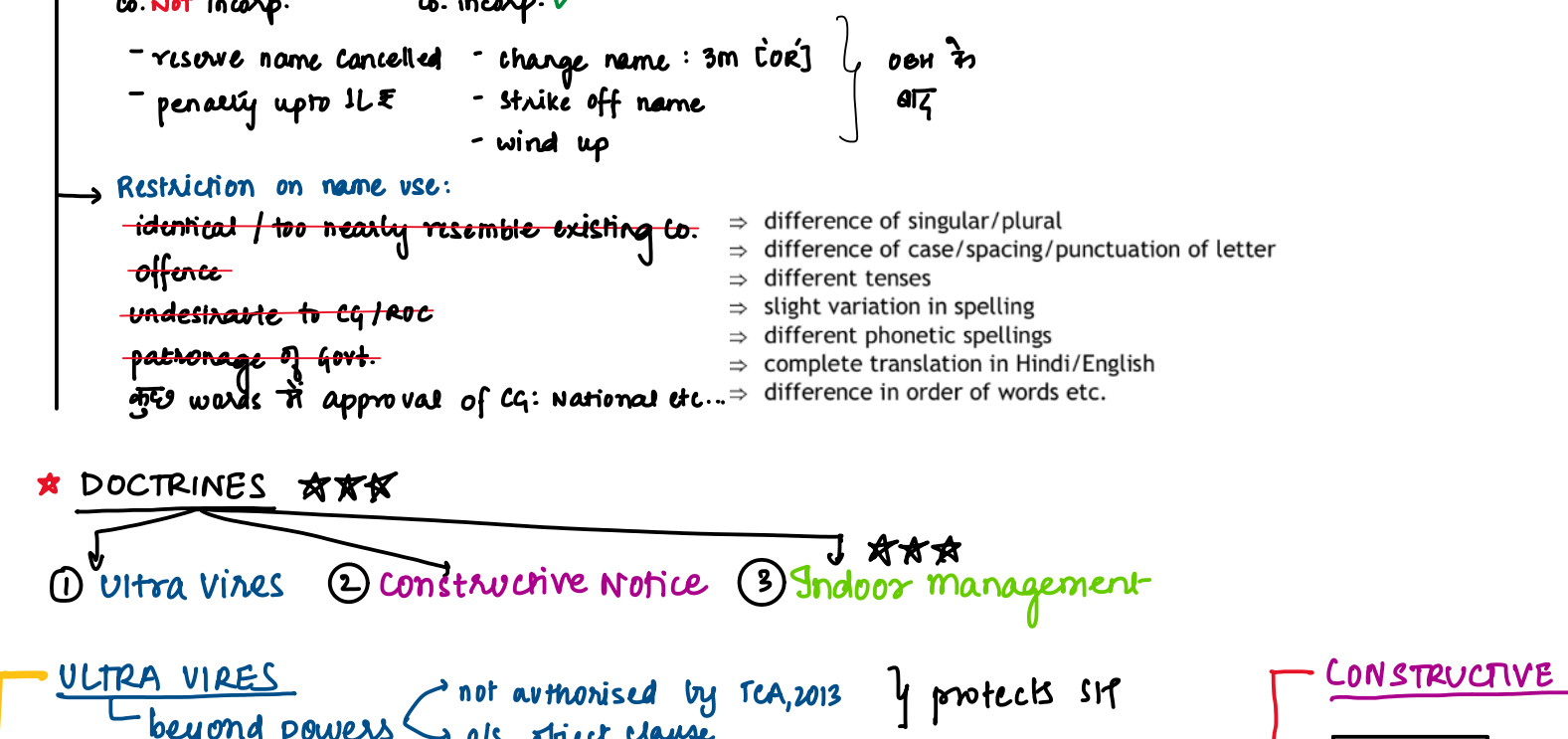

Sec 9 Registrar

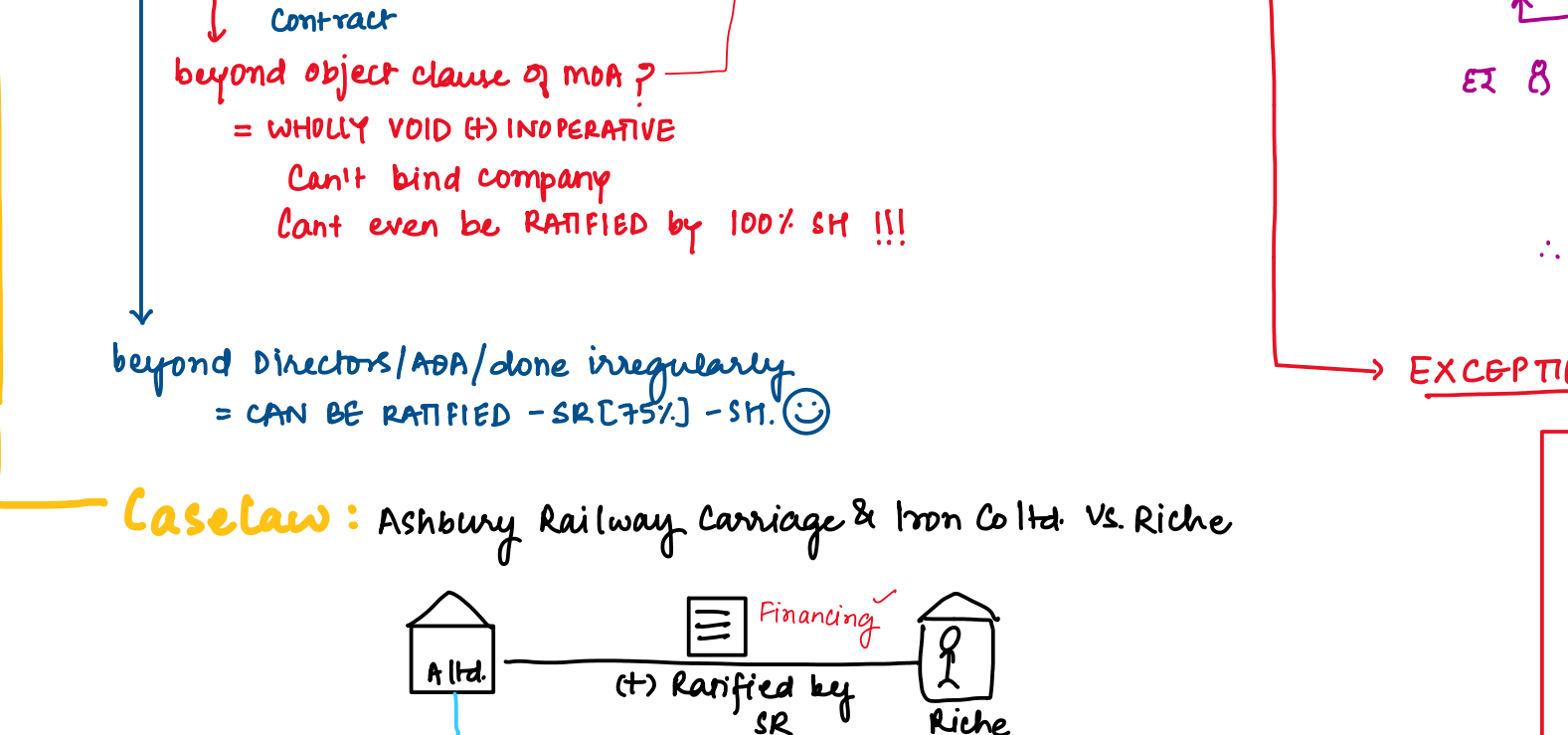

Sec 10 Name

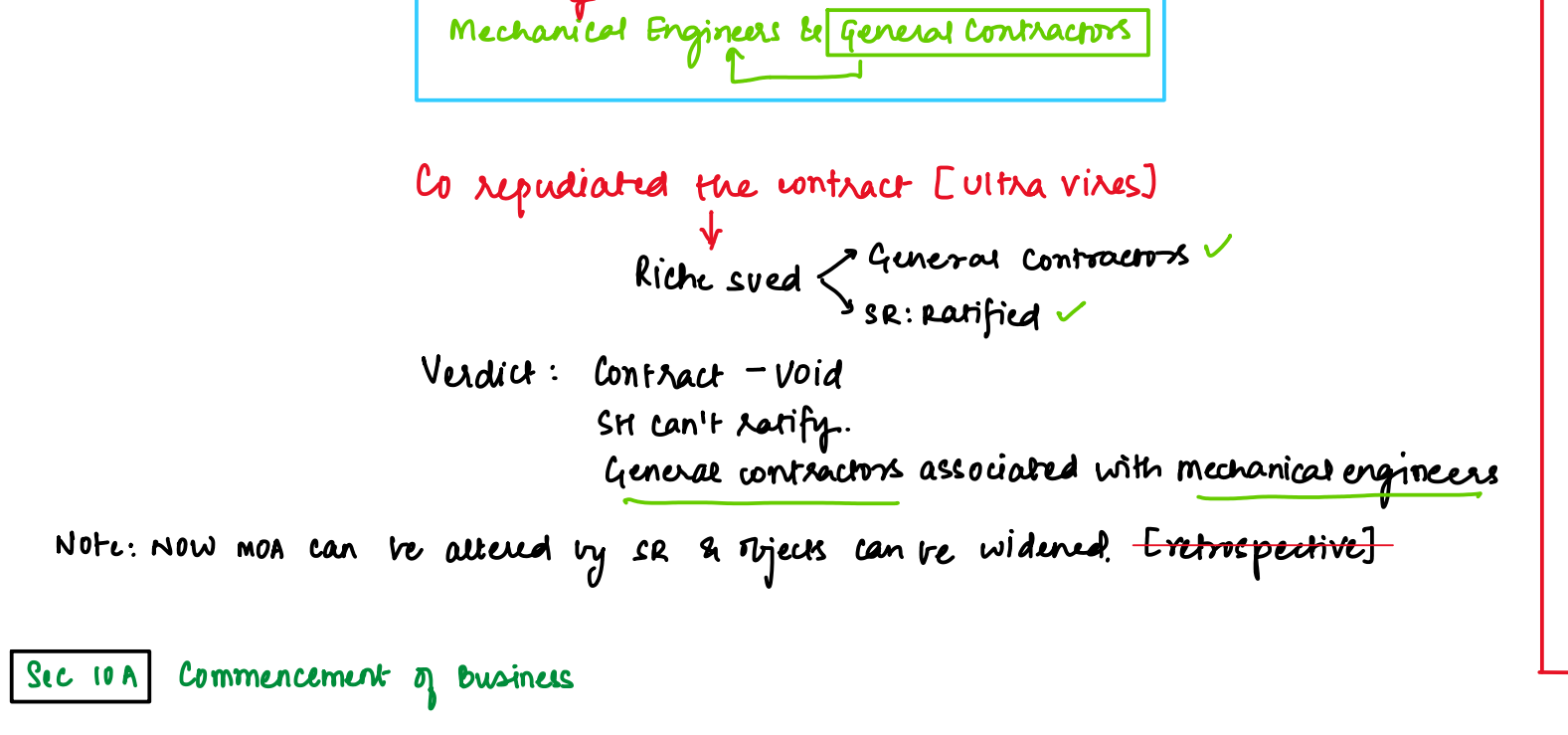

Sec 11 Commencement of Business

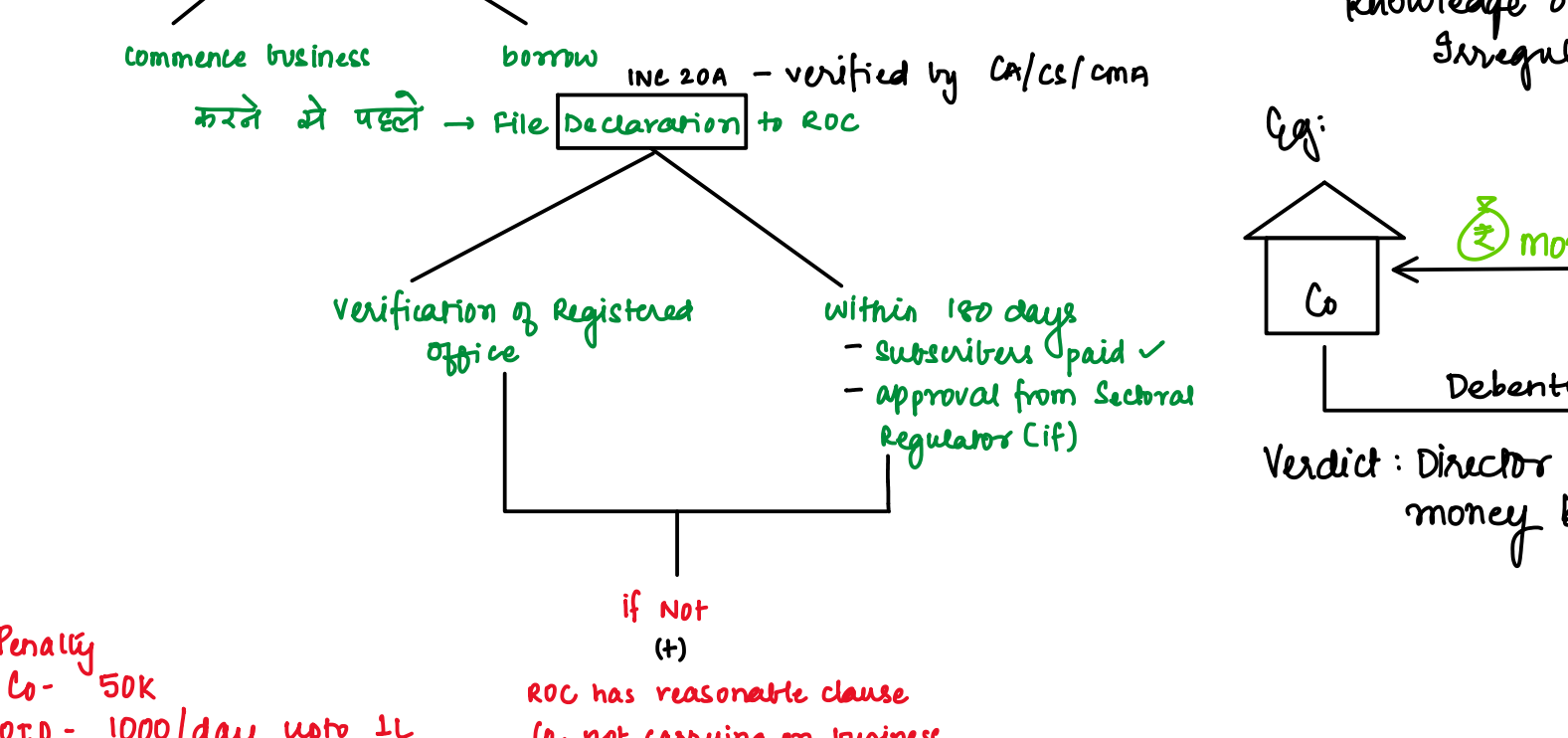

Sec 12 Publicity

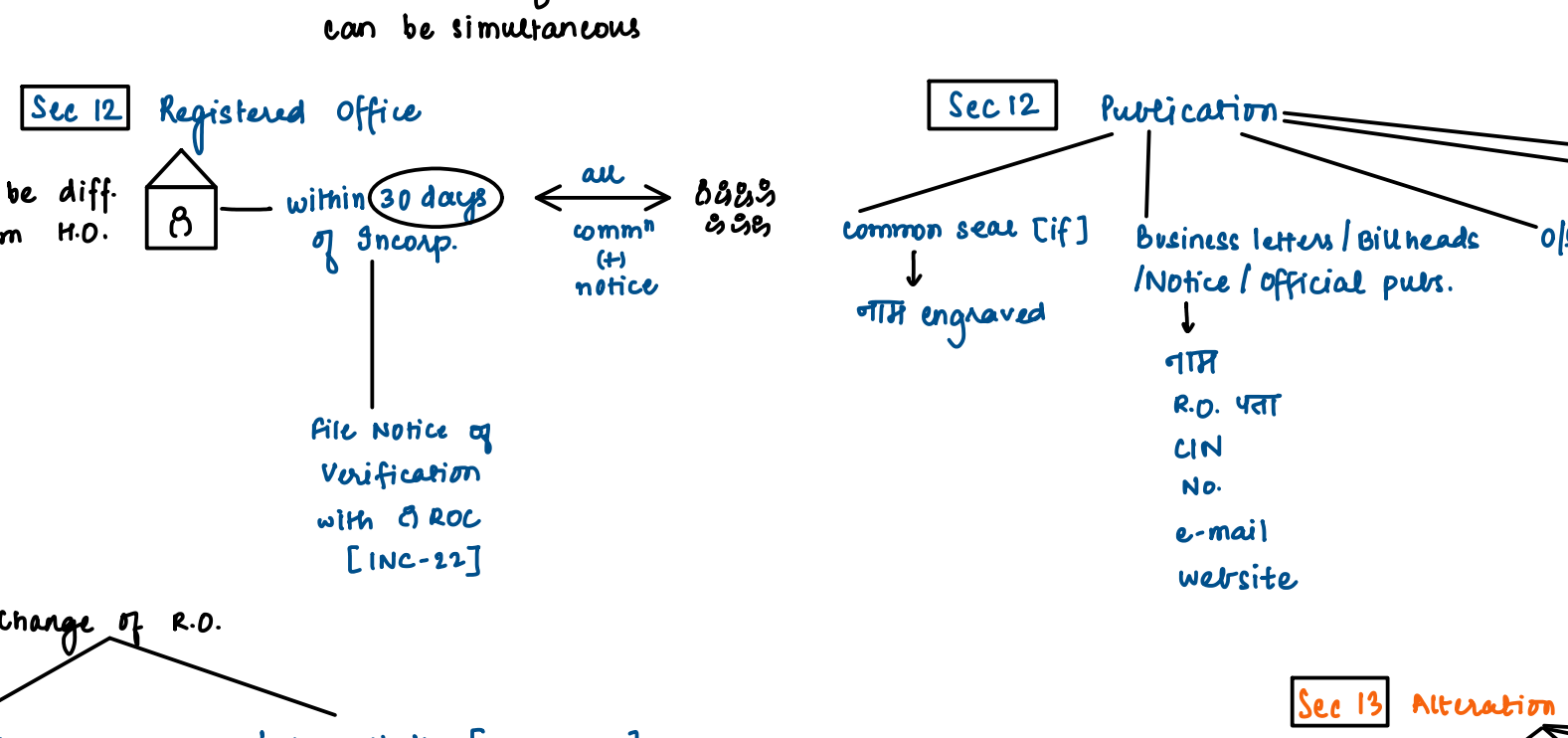

Sec 13 Alteration of MOA

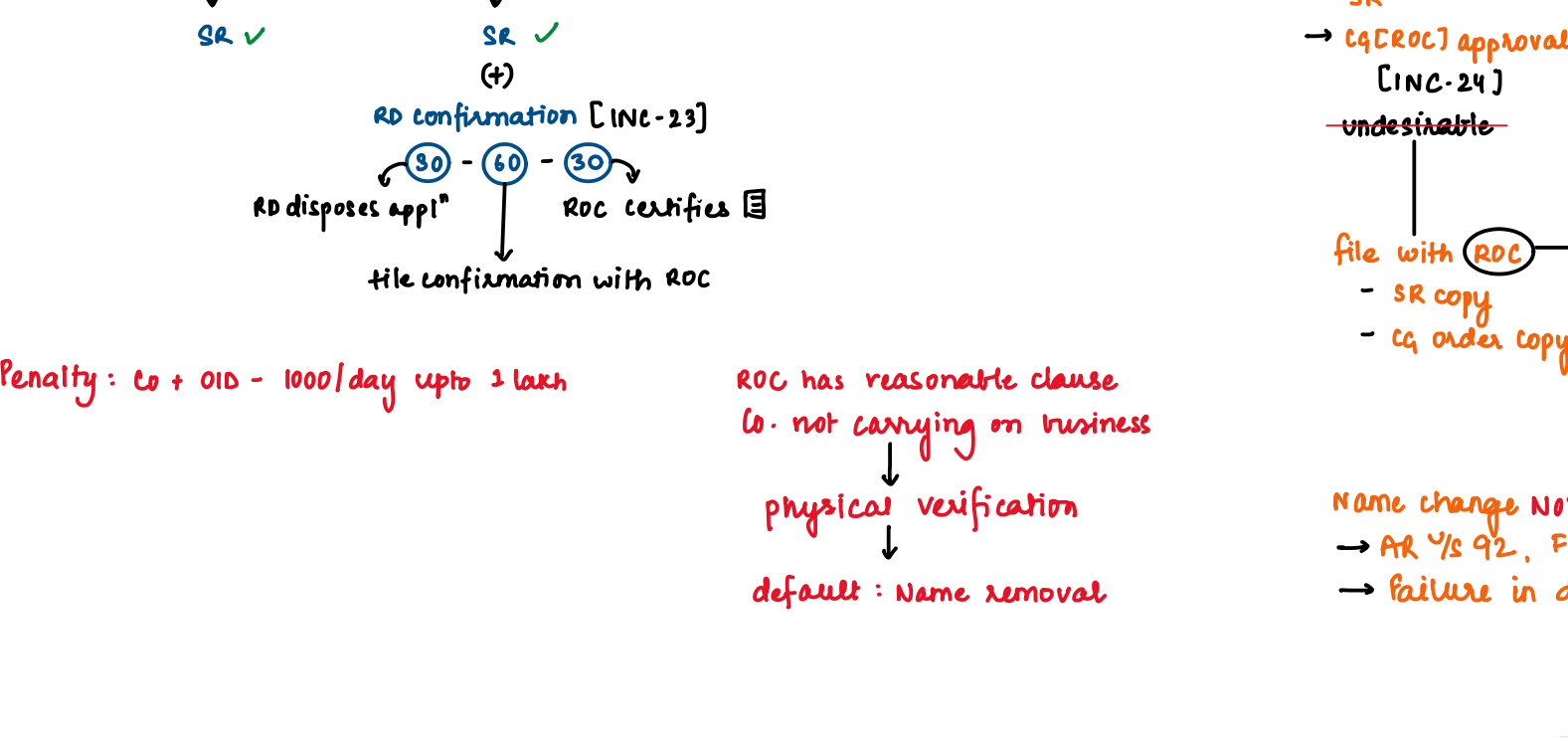

Sec 14 Alteration of AOA

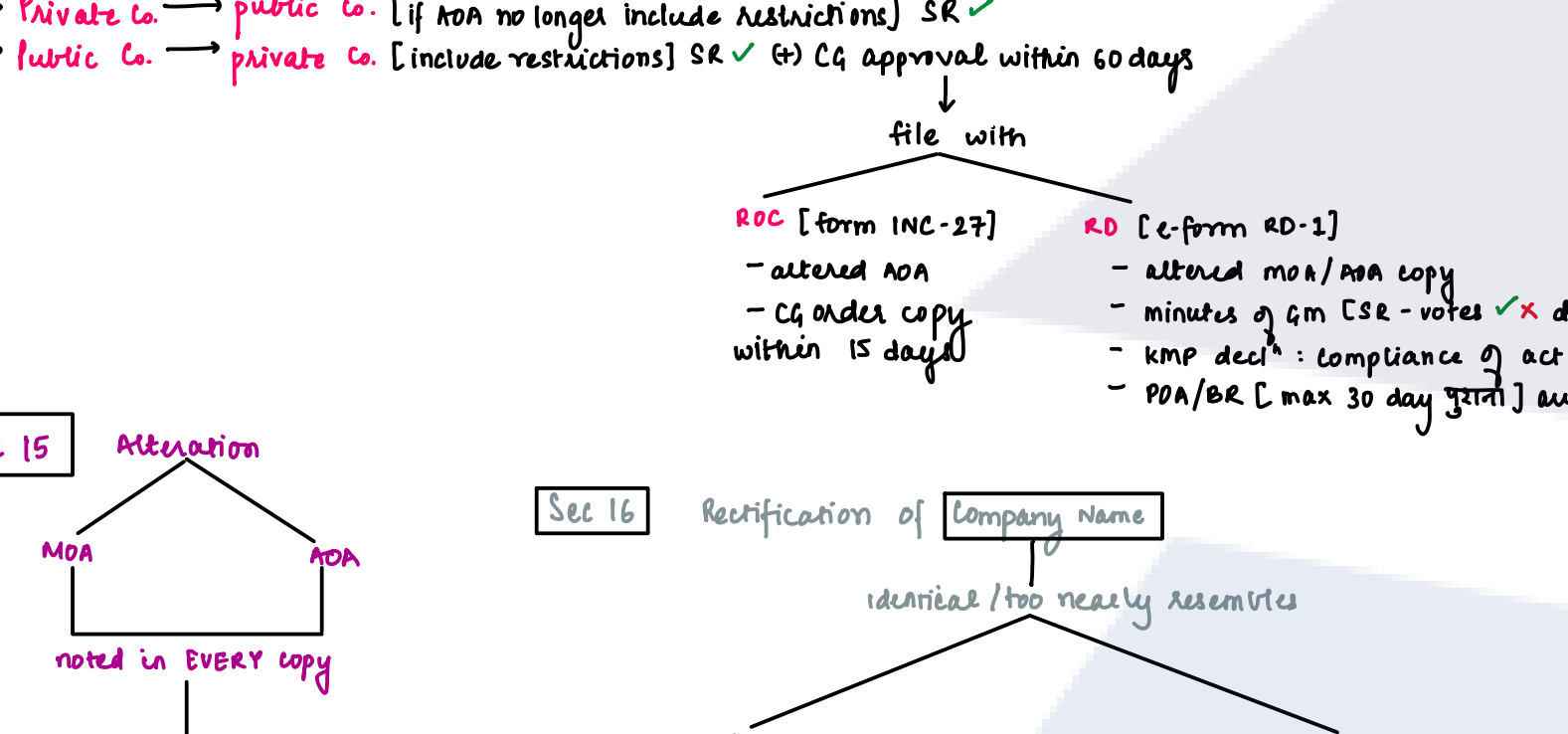

Sec 15 Alteration of Name

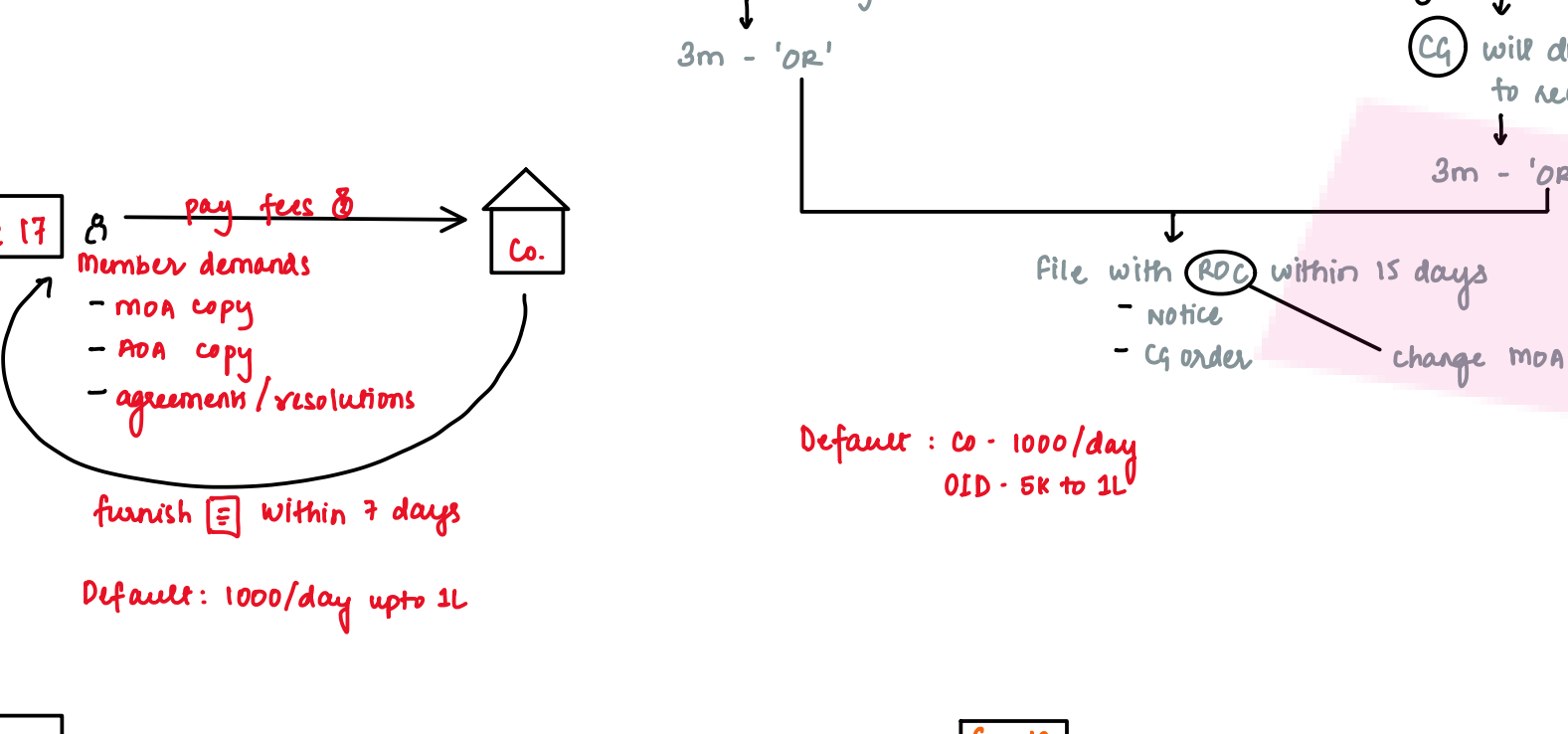

Sec 16 Alteration of Capital

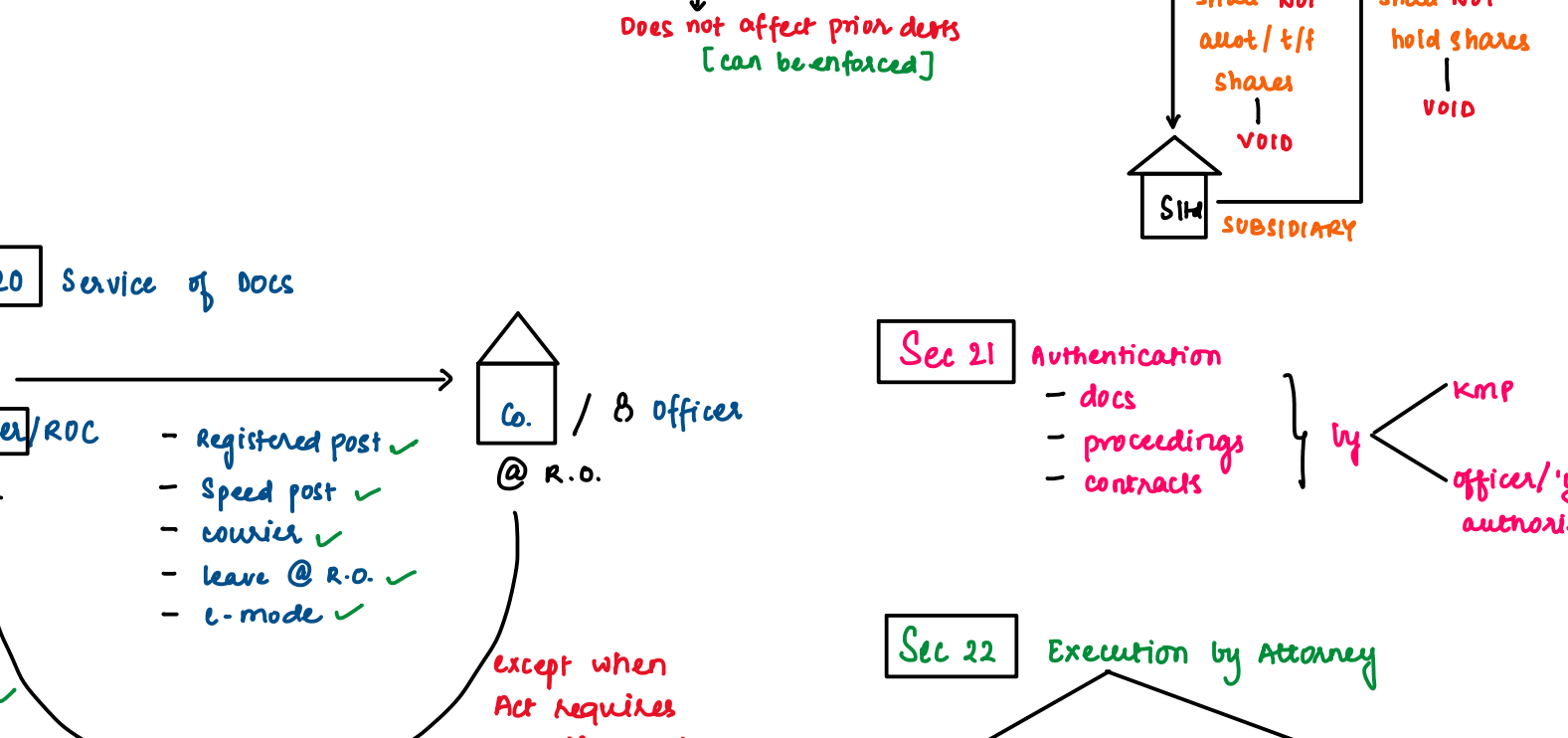

Sec 17 Alteration of Shares

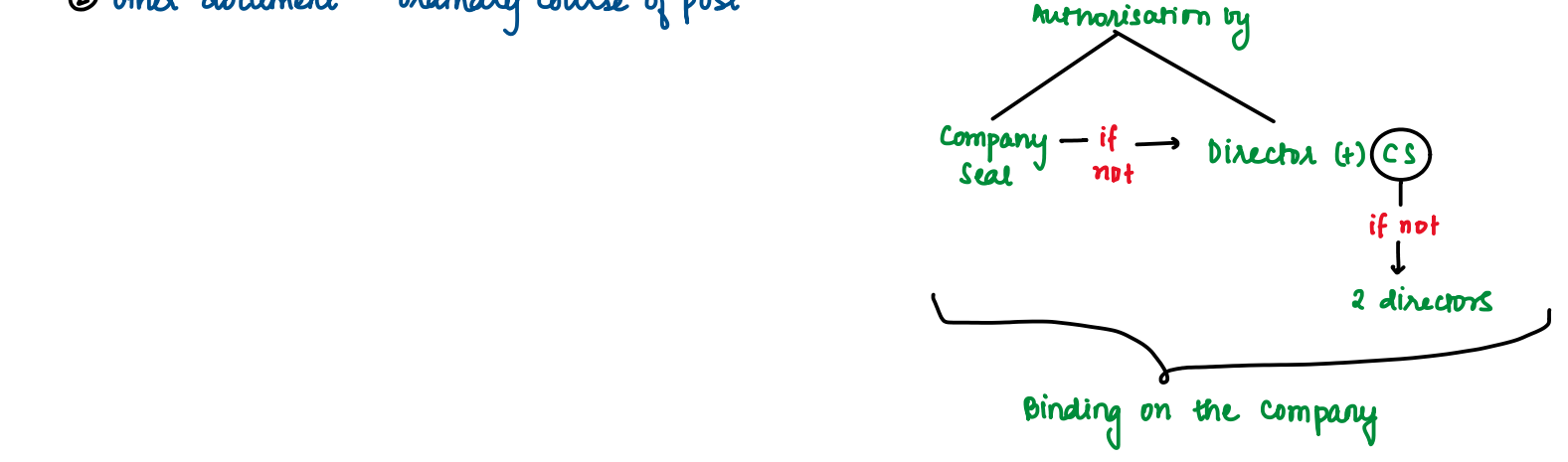

Sec 18 Alteration of Directors



Sec 19 Alteration of Registrar



Sec 20 Alteration of Name



Sec 21 Alteration of Capital



Sec 22 Alteration of Shares



Sec 23 Alteration of Directors



Sec 24 Alteration of Registrar



Sec 25 Alteration of Name



Sec 26 Alteration of Capital



Sec 27 Alteration of Shares



Sec 28 Alteration of Directors



Sec 29 Alteration of Registrar



Sec 30 Alteration of Name



Sec 31 Alteration of Capital



Sec 32 Alteration of Shares



Sec 33 Alteration of Directors



Sec 34 Alteration of Registrar



Sec 35 Alteration of Name



Sec 36 Alteration of Capital



Sec 37 Alteration of Shares



Sec 38 Alteration of Directors



Sec 39 Alteration of Registrar



Sec 40 Alteration of Name



Sec 41 Alteration of Capital



Sec 42 Alteration of Shares



Sec 43 Alteration of Directors



Sec 44 Alteration of Registrar



Sec 45 Alteration of Name



Sec 46 Alteration of Capital



Sec 47 Alteration of Shares



Sec 48 Alteration of Directors



Sec 49 Alteration of Registrar



Sec 50 Alteration of Name



Sec 51 Alteration of Capital



Sec 52 Alteration of Shares



Sec 53 Alteration of Directors



Sec 54 Alteration of Registrar



Sec 55 Alteration of Name



Sec 56 Alteration of Capital



Sec 57 Alteration of Shares



Sec 58 Alteration of Directors



Sec 59 Alteration of Registrar



Sec 60 Alteration of Name



Sec 61 Alteration of Capital



Sec 62 Alteration of Shares



Sec 63 Alteration of Directors



Sec 64 Alteration of Registrar



Sec 65 Alteration of Name



Sec 66 Alteration of Capital



Sec 67 Alteration of Shares



Sec 68 Alteration of Directors



Sec 69 Alteration of Registrar



Sec 70 Alteration of Name



Sec 71 Alteration of Capital



Sec 72 Alteration of Shares



Sec 73 Alteration of Directors



Sec 74 Alteration of Registrar



Sec 75 Alteration of Name



Sec 76 Alteration of Capital



Sec 77 Alteration of Shares



Sec 78 Alteration of Directors



Sec 79 Alteration of Registrar



Sec 80 Alteration of Name



Sec 81 Alteration of Capital



Sec 82 Alteration of Shares



Sec 83 Alteration of Directors



Sec 84 Alteration of Registrar



Sec 85 Alteration of Name



Sec 86 Alteration of Capital



Sec 87 Alteration of Shares



Sec 88 Alteration of Directors



Sec 89 Alteration of Registrar



Sec 90 Alteration of Name



Sec 91 Alteration of Capital



Sec 92 Alteration of Shares



Sec 93 Alteration of Directors



Sec 94 Alteration of Registrar



Sec 95 Alteration of Name



Sec 96 Alteration of Capital



Sec 97 Alteration of Shares



Sec 98 Alteration of Directors



Sec 99 Alteration of Registrar



Sec 100 Alteration of Name



Sec 101 Alteration of Capital



Sec 102 Alteration of Shares



Sec 103 Alteration of Directors



Sec 104 Alteration of Registrar



Sec 105 Alteration of Name



Sec 106 Alteration of Capital



Sec 107 Alteration of Shares



Sec 108 Alteration of Directors



Sec 109 Alteration of Registrar



Sec 110 Alteration of Name



Sec 111 Alteration of Capital



Sec 112 Alteration of Shares



Sec 113 Alteration of Directors



Sec 114 Alteration of Registrar



Sec 115 Alteration of Name



Sec 116 Alteration of Capital



Sec 117 Alteration of Shares



Sec 118 Alteration of Directors



Sec 119 Alteration of Registrar



Sec 120 Alteration of Name



Sec 121 Alteration of Capital



Sec 122 Alteration of Shares



Sec 123 Alteration of Directors



Sec 124 Alteration of Registrar



Sec 125 Alteration of Name



Sec 126 Alteration of Capital



Sec 127 Alteration of Shares