

How an Act is Passed ?

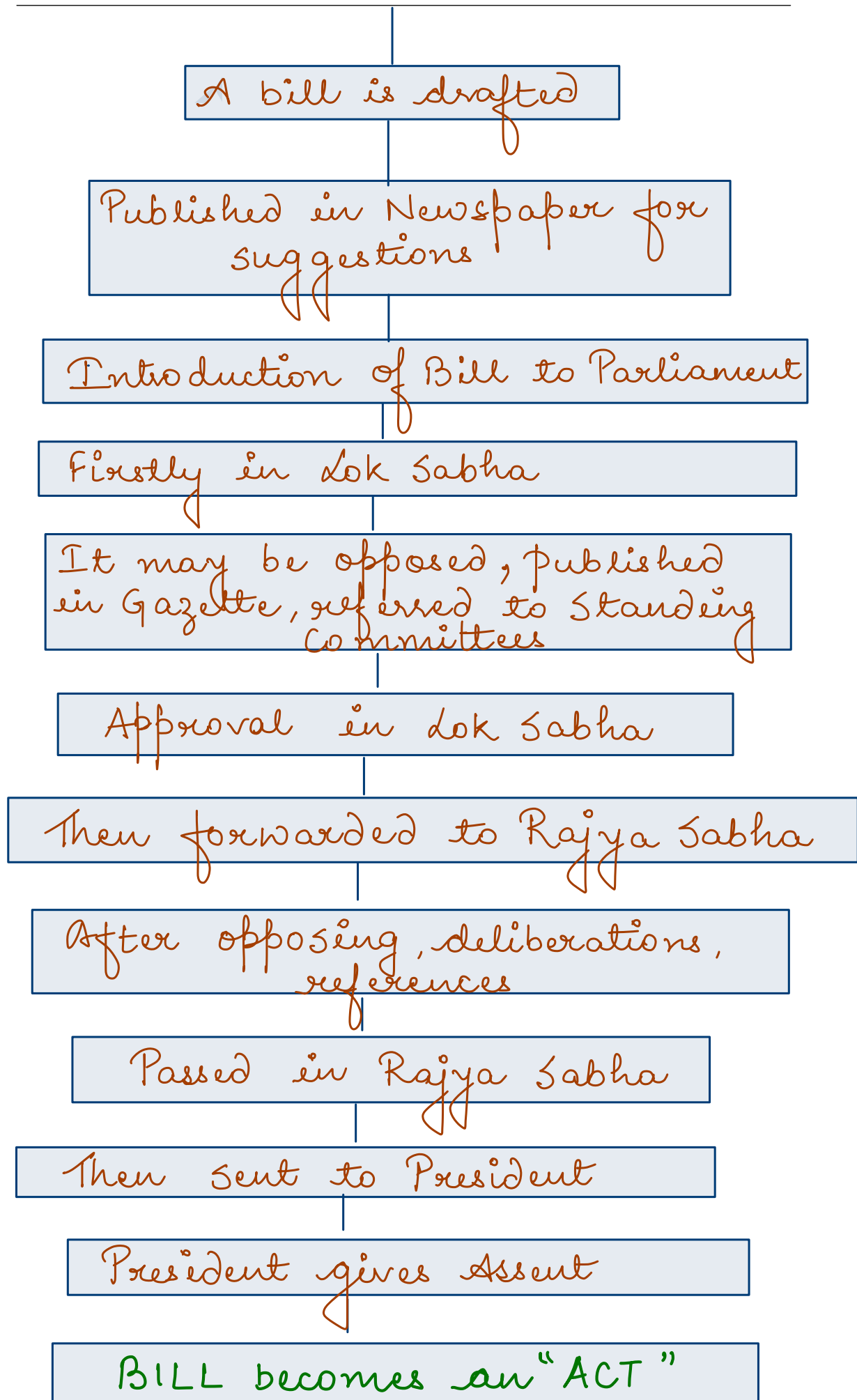

Corporate law

Companies Act, 2013

By powers under Entry 97 of Union list Parliament got Power

Introduced in 2008 but after rejections & referrals, got approved in

Dec. 2012 → by Lok Sabha
Aug 2013 → " Rajya Sabha
29 Aug 2013 → By President

Bill became Companies Act, 2013 to regulate

this form of Business Organisation

COMPANY

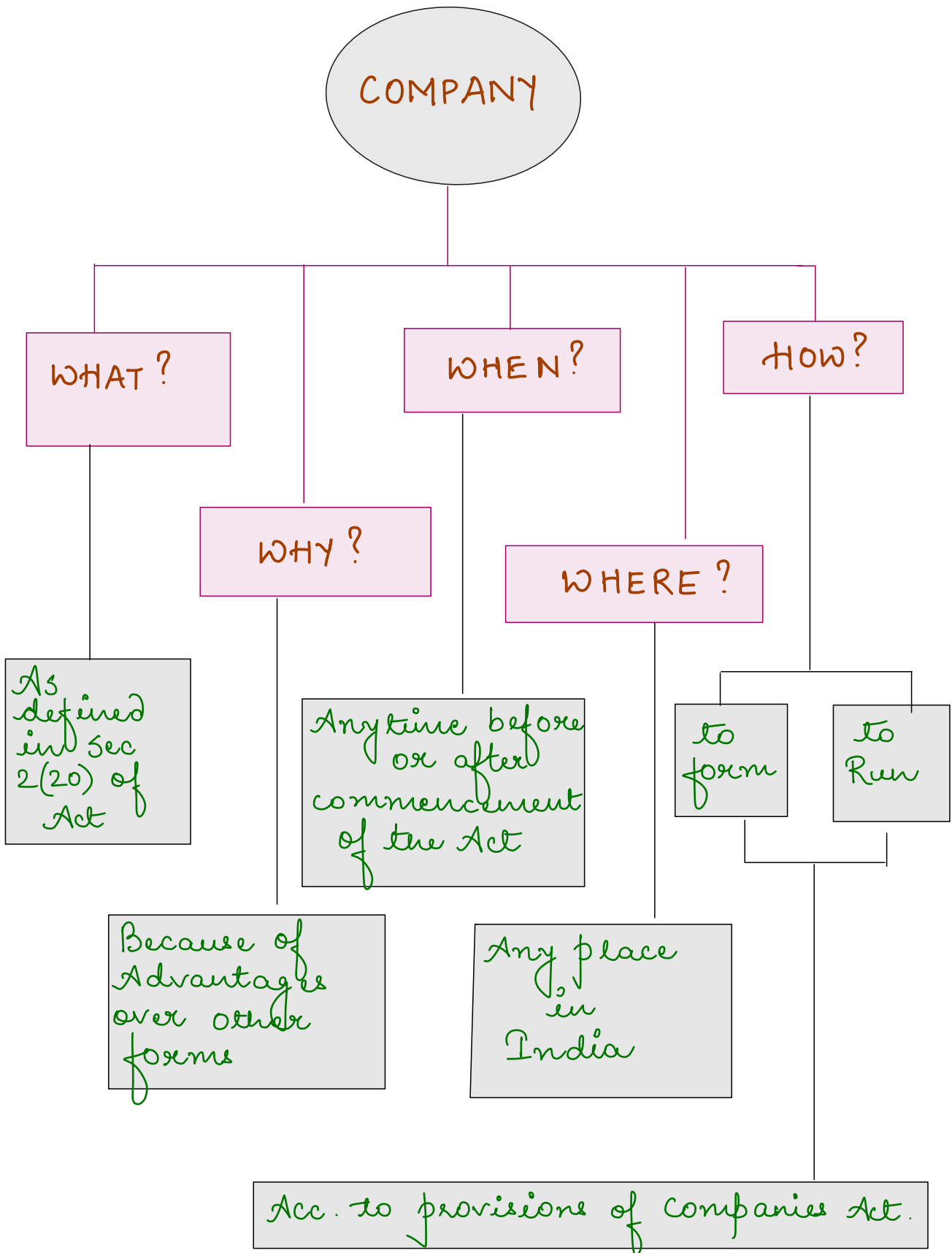

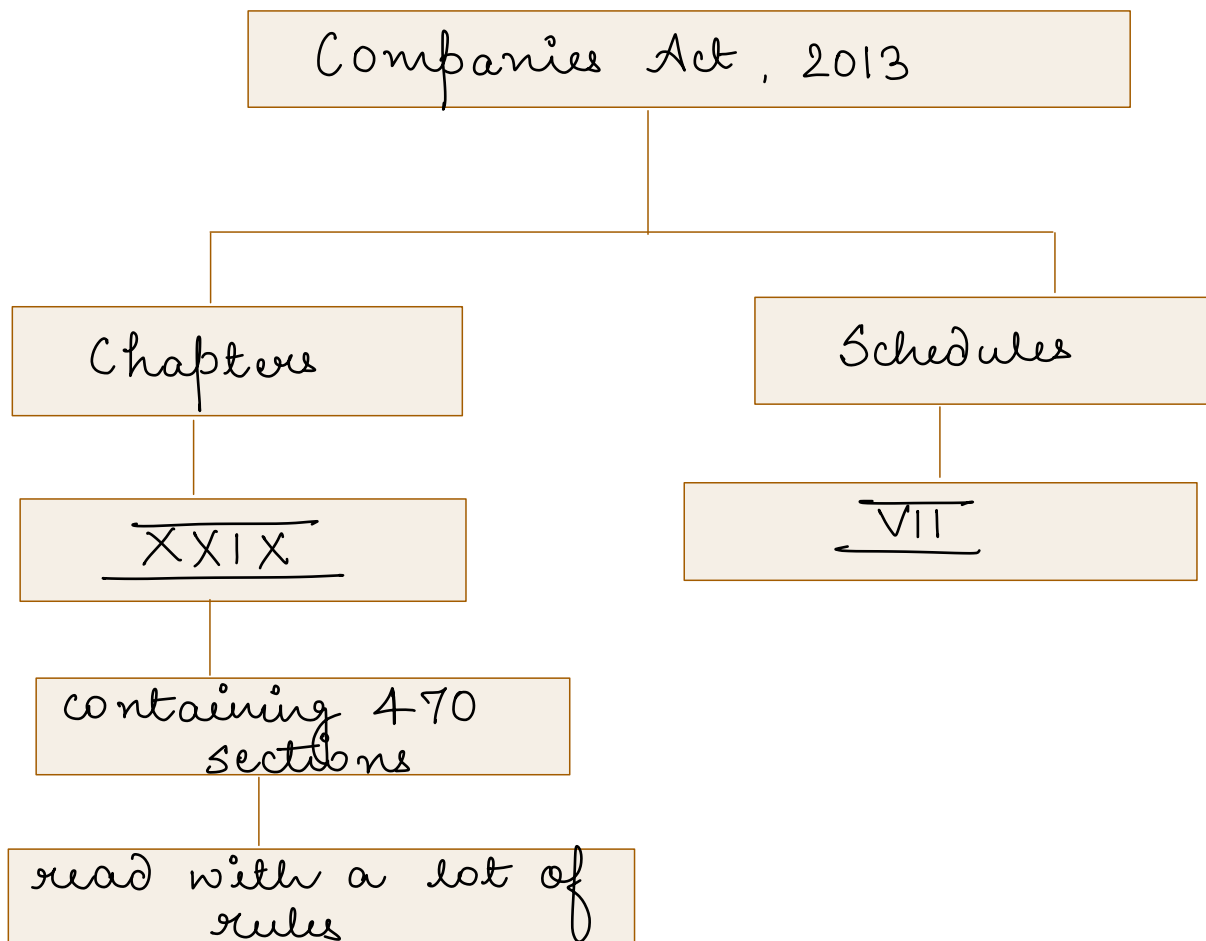

In CA - Inter Syllabus

Chapter I to X

containing sections 1 - 148.
with relevant rules.

Act was notified in Parts :-
Section 1 notified on 30th Aug 2013
98 sections " " 12th Sep. 2013
183 " " 1st April 2014 and so on..

Companies Act, 1956 has been completely repealed and New Act has been now implemented completely.

Extends to whole of India. Applicable also to Banking, Insurance, Electricity co's so far provisions are consistent with respective Laws

Chapter I ~ Preliminary [Section 1 & 2]

Section 2 :- Definitions

Private Company [Section 2(68)]

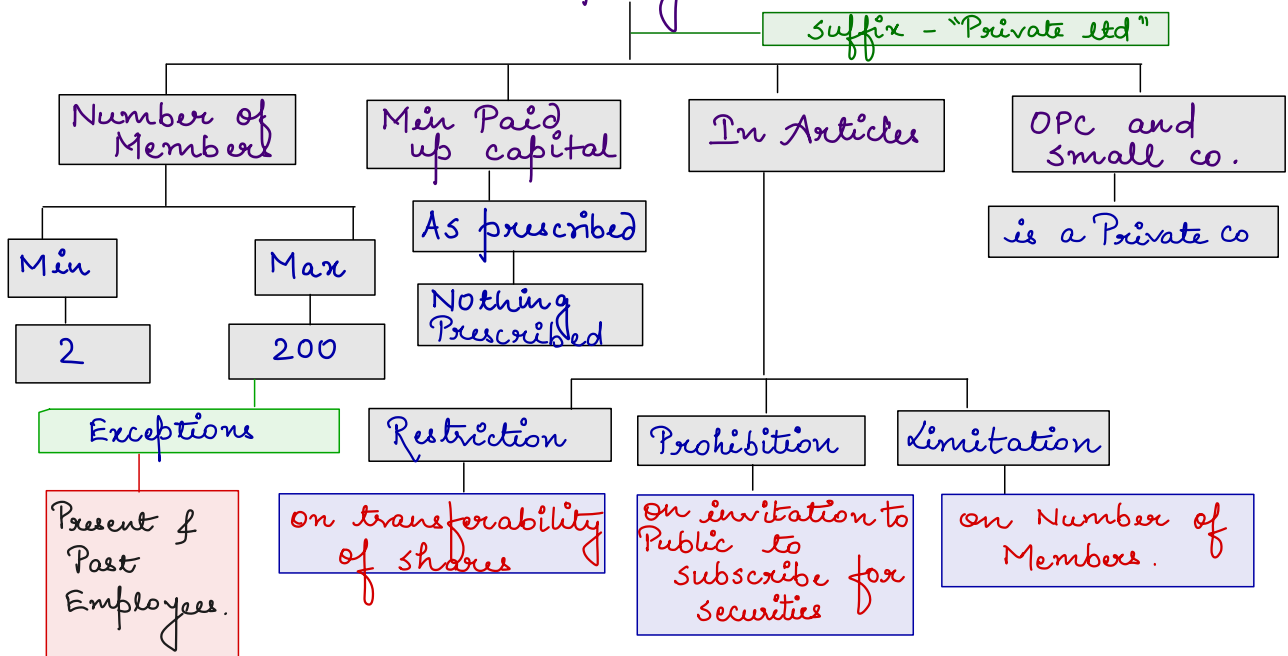

Public Company [Section 2(71)]

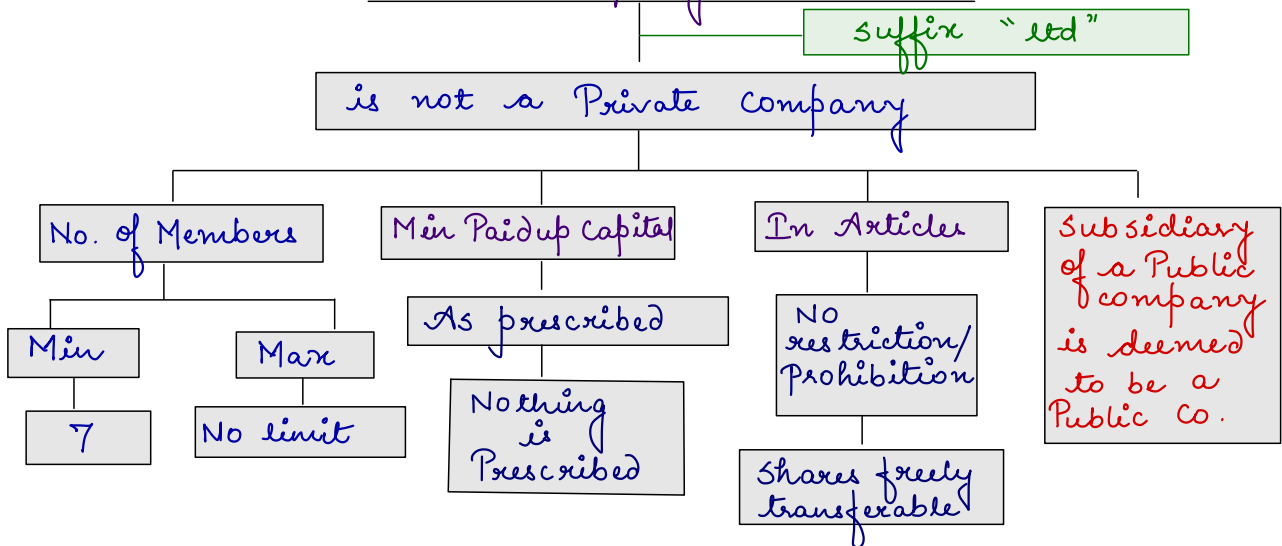

One Person Company [Section 2(62)]

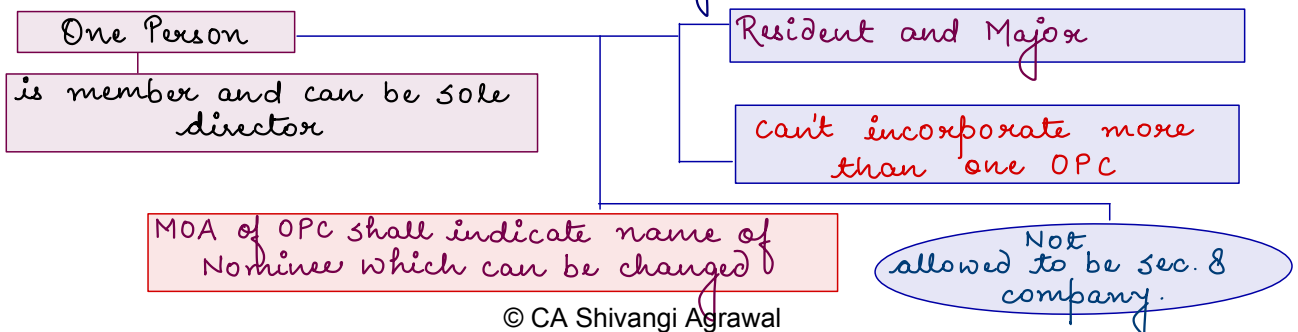

Holding Company [Section 2(46)]

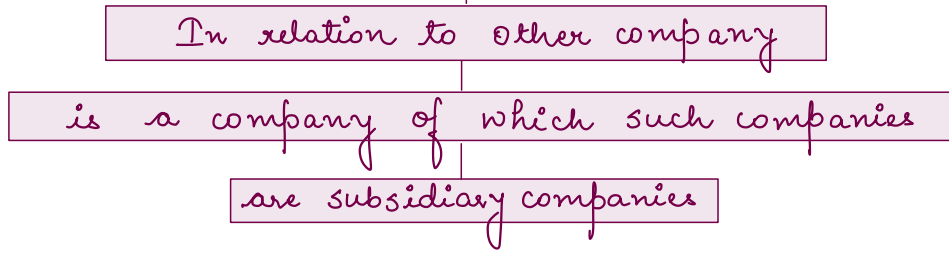

Subsidiary Company [Section 2(87)]

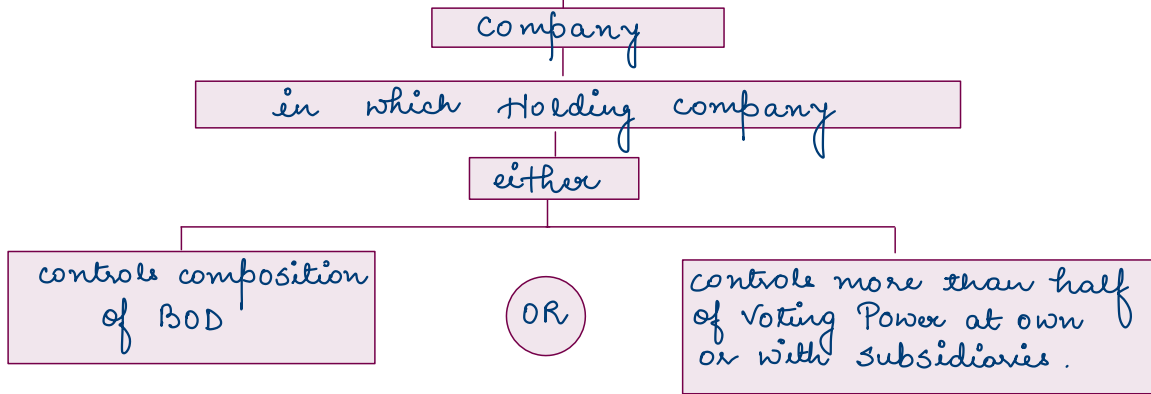

No company shall have more than 2 layers of subsidiaries.

Associate Company [Section 2(6)]

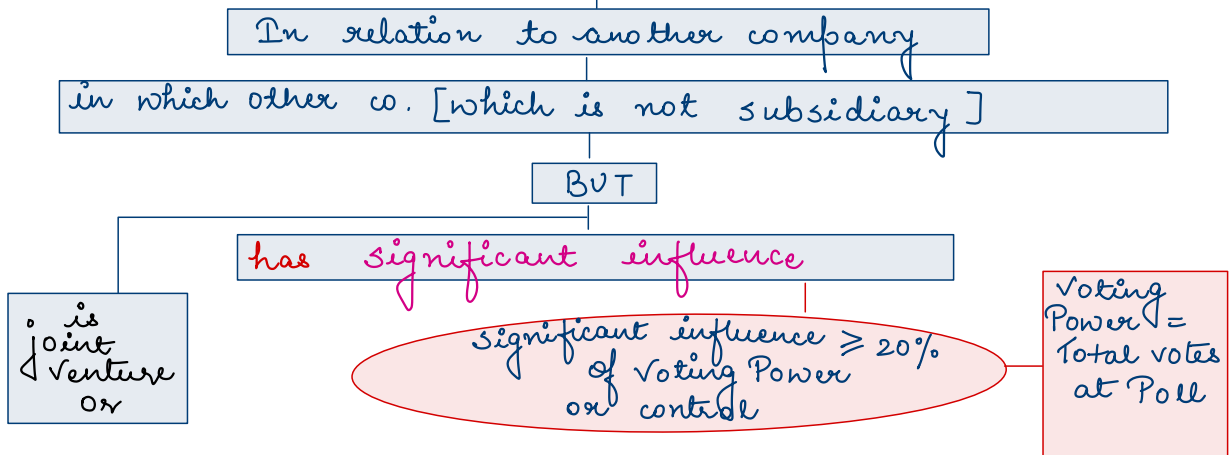

Small Company [Section 2(85)]

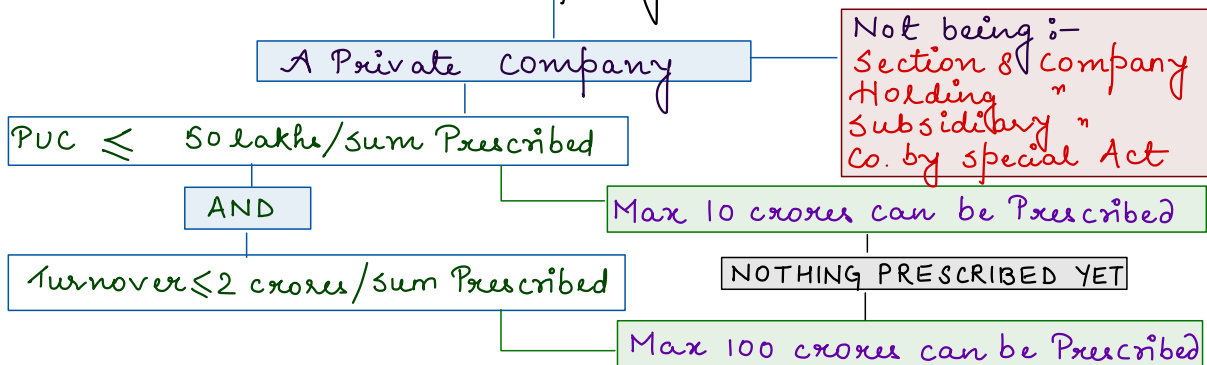

Section 8 Company

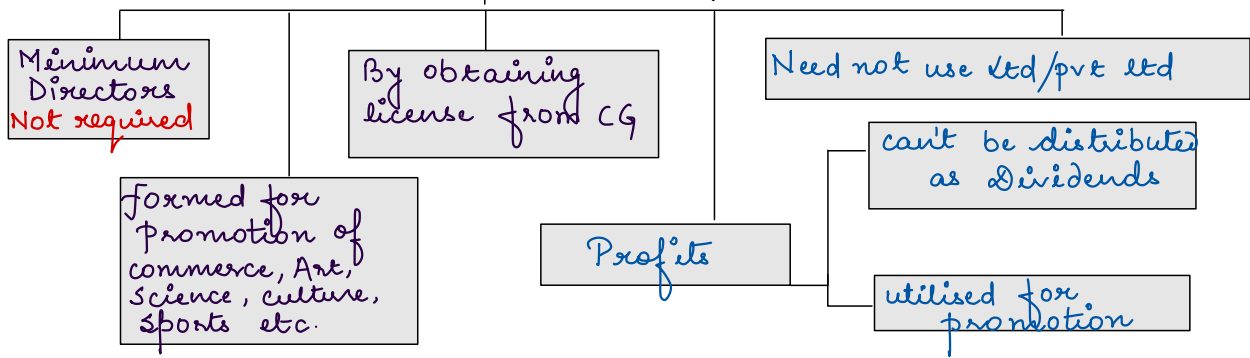

Government Company [Section 2(45)]

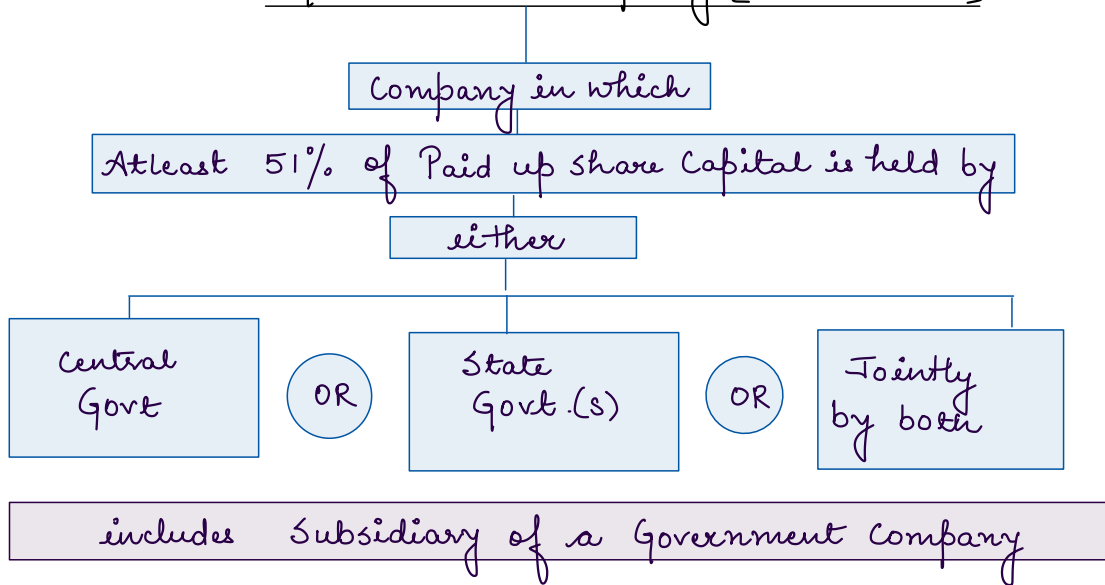

Foreign Company [Section 2(42)]

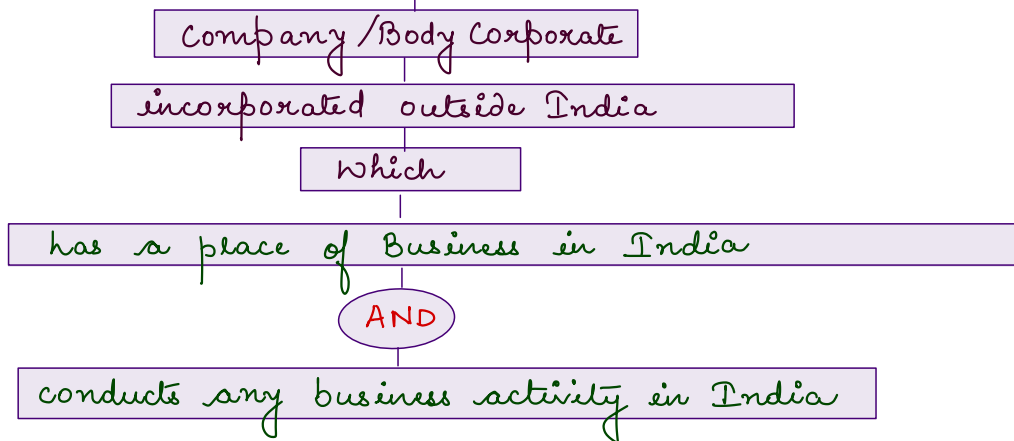

Dormant Company [Sec. 455]

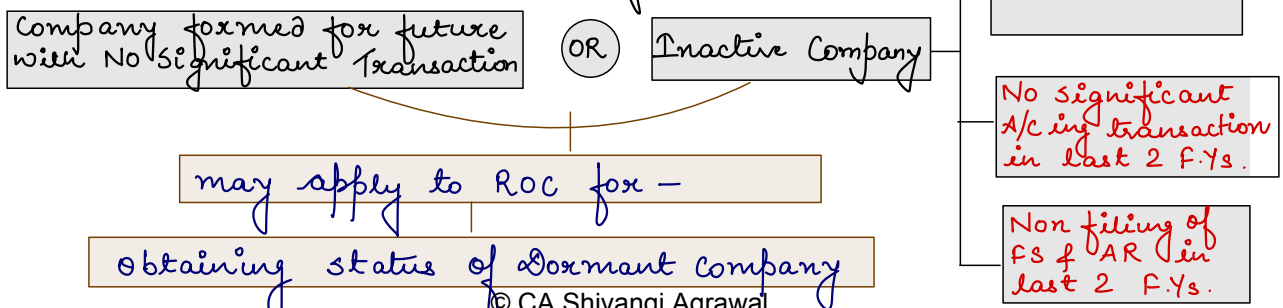

Financial Year [Section 2(41)]

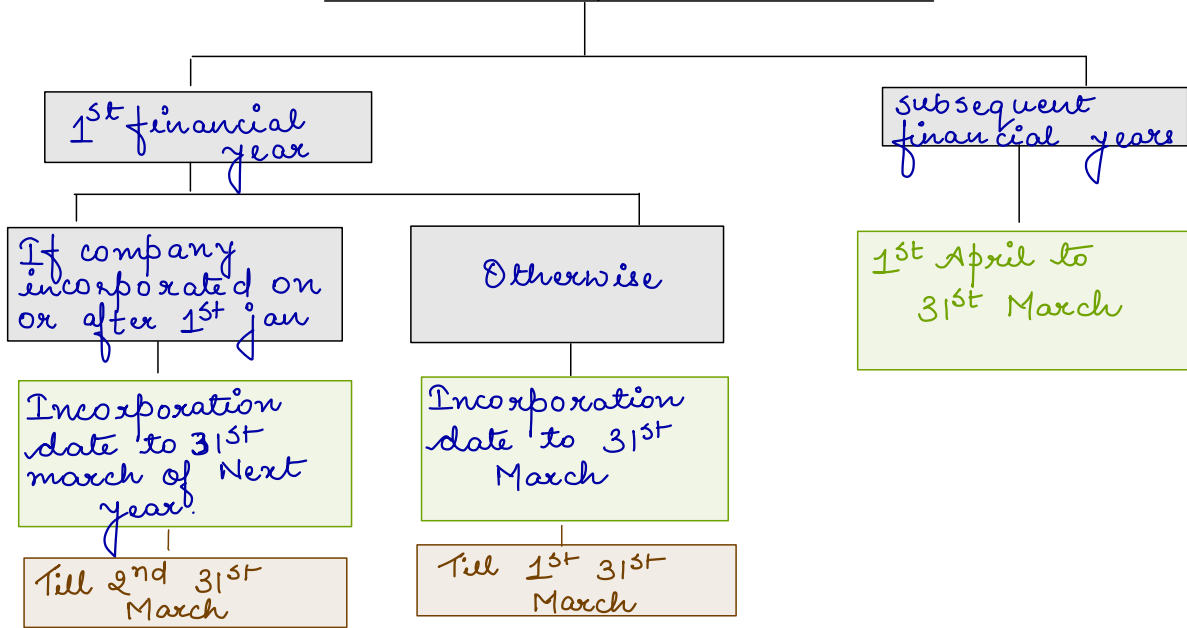

Incorporation of Company and Matters Incidental thereto

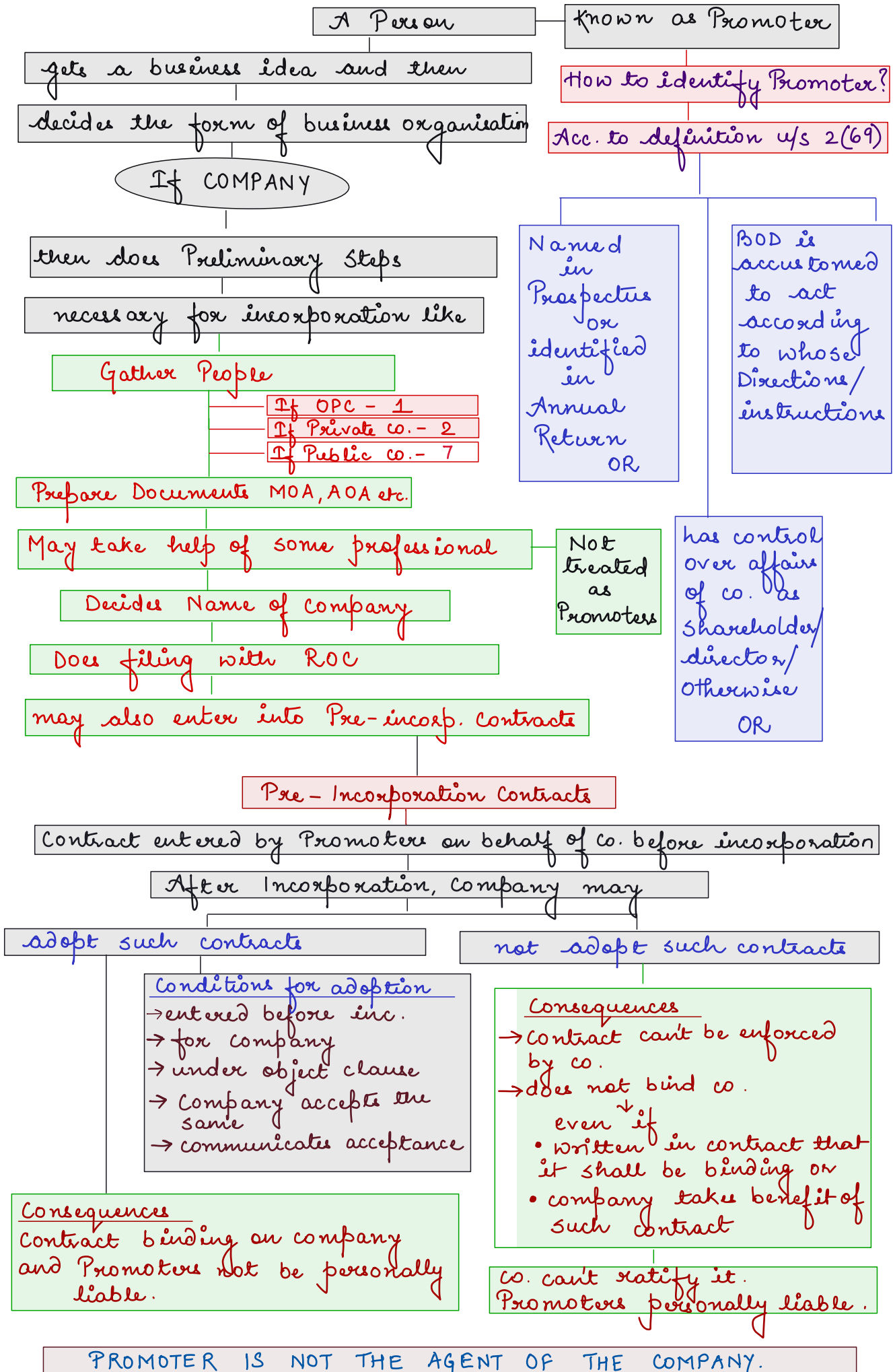

PROMOTER IS NOT THE AGENT OF THE COMPANY.

Duties and Remuneration of Promoters

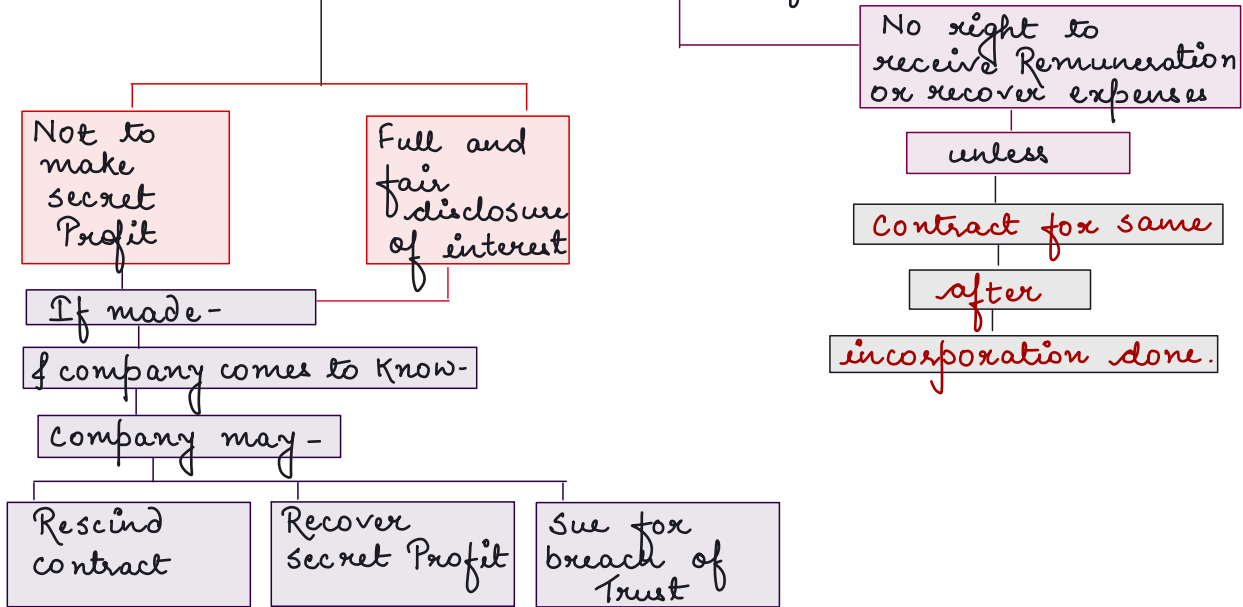

Members liable in Certain Cases [Section 3A]

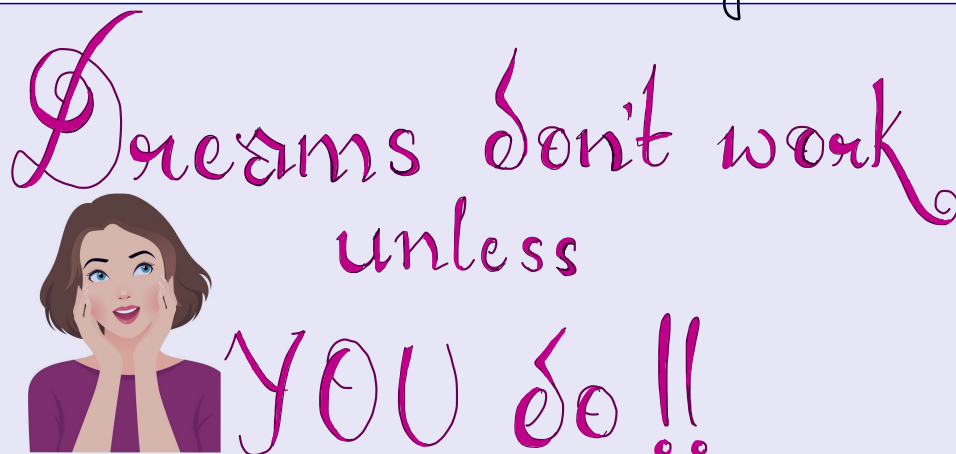
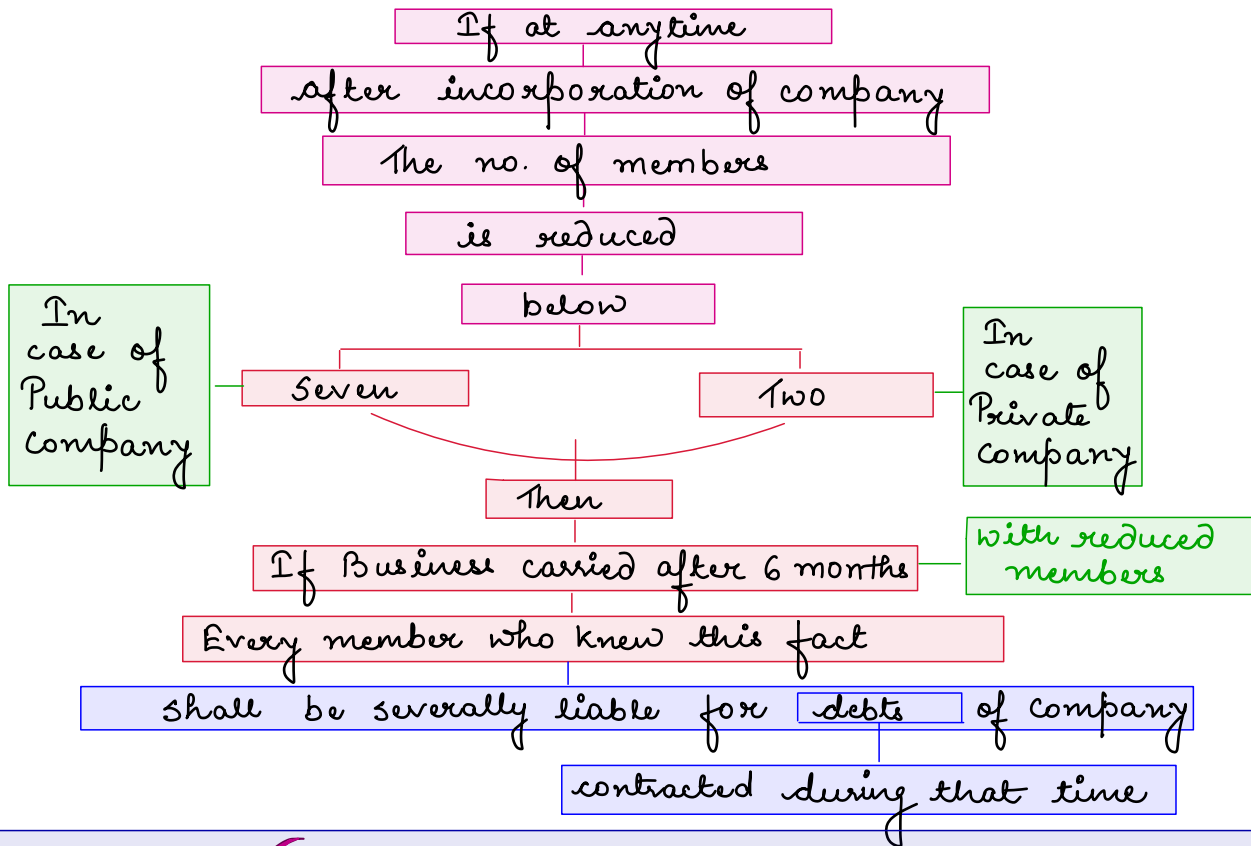

Memorandum Of Association

[Section 4]

Memorandum

As defined u/s 2(56)

It is a document containing fundamental Provs. of constitution

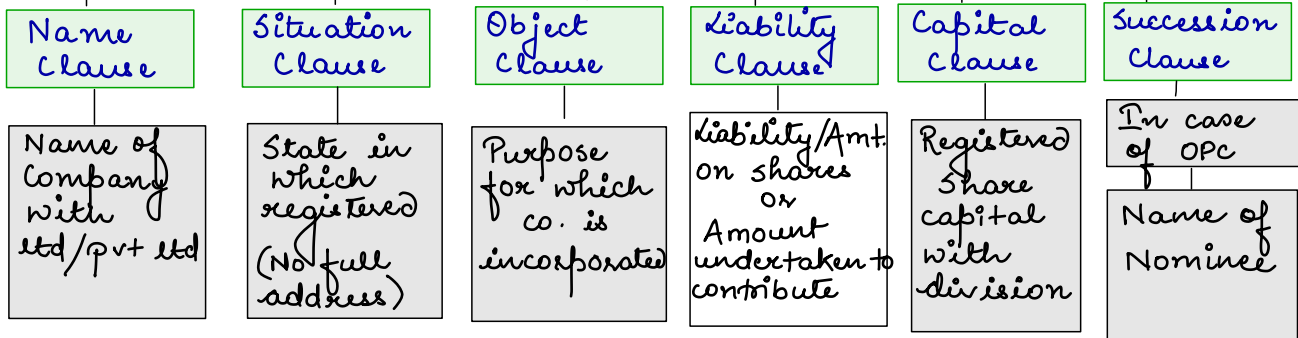

Respective forms specified in Schedule I

Printed, signed, divided into Paragraphs, numbered, witnessed

Must be prepared by every company

required at the time of registration

can be altered later according to sec. 13

Articles Of Association

[Section 5]

Articles

As defined u/s 2(5)

The internal regulations of company for own Governance

A company may adopt all or any of Provision

given in respective Tables of Schedule I

Printed, signed, divided into Paragraphs, numbered, witnessed

Must be prepared by every company

required at the time of registration

be altered later according to sec. 14

can be made more strict by adding

Entrenchment Provision

at the time of formation of co.

OR Later on by Amendment

file INC-32

In Private Company

In Public Company

If agreed by all members

If SR passed

Process of Incorporation

Step 1:- Name Reservation

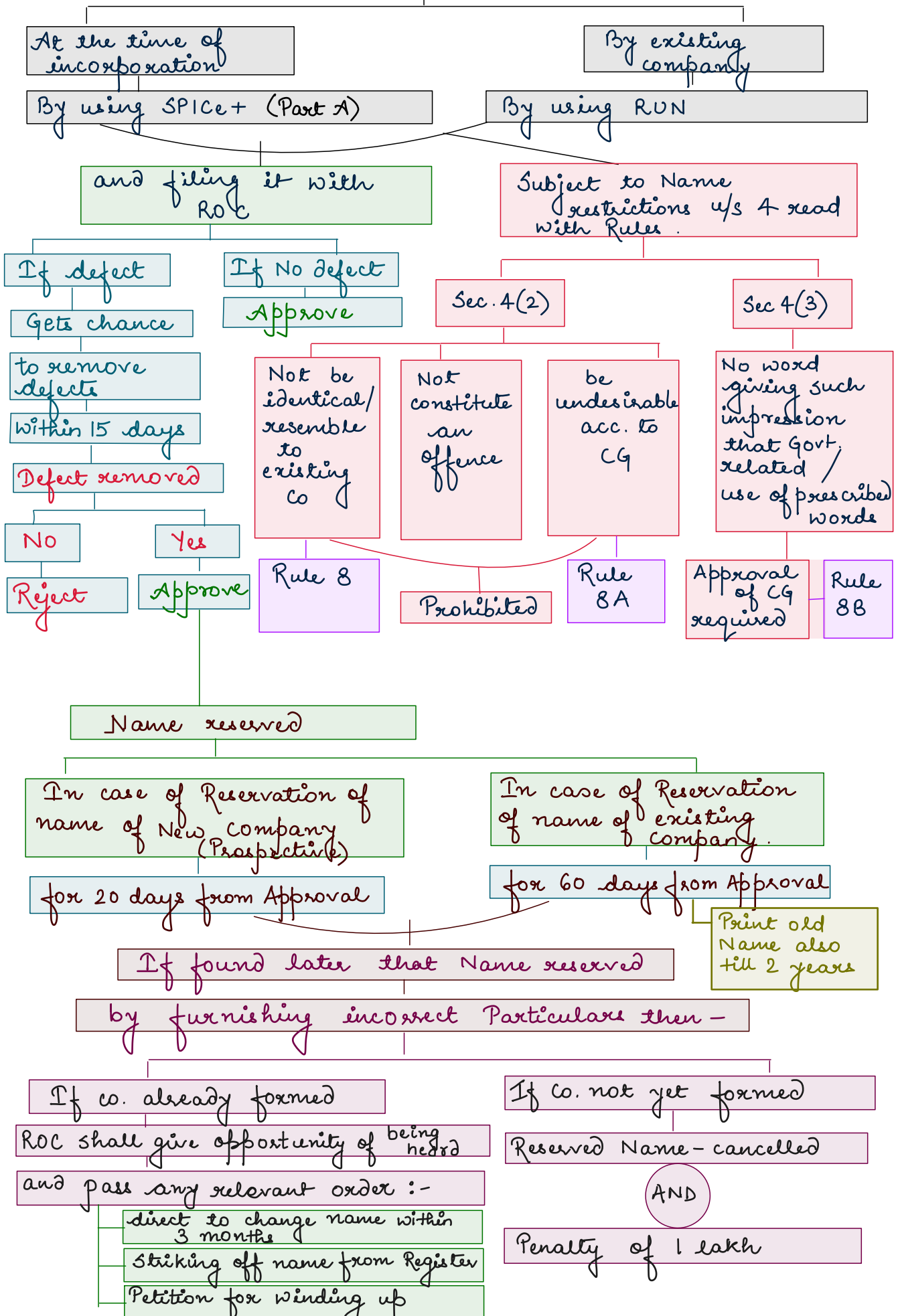

Process of Incorporation

Other steps

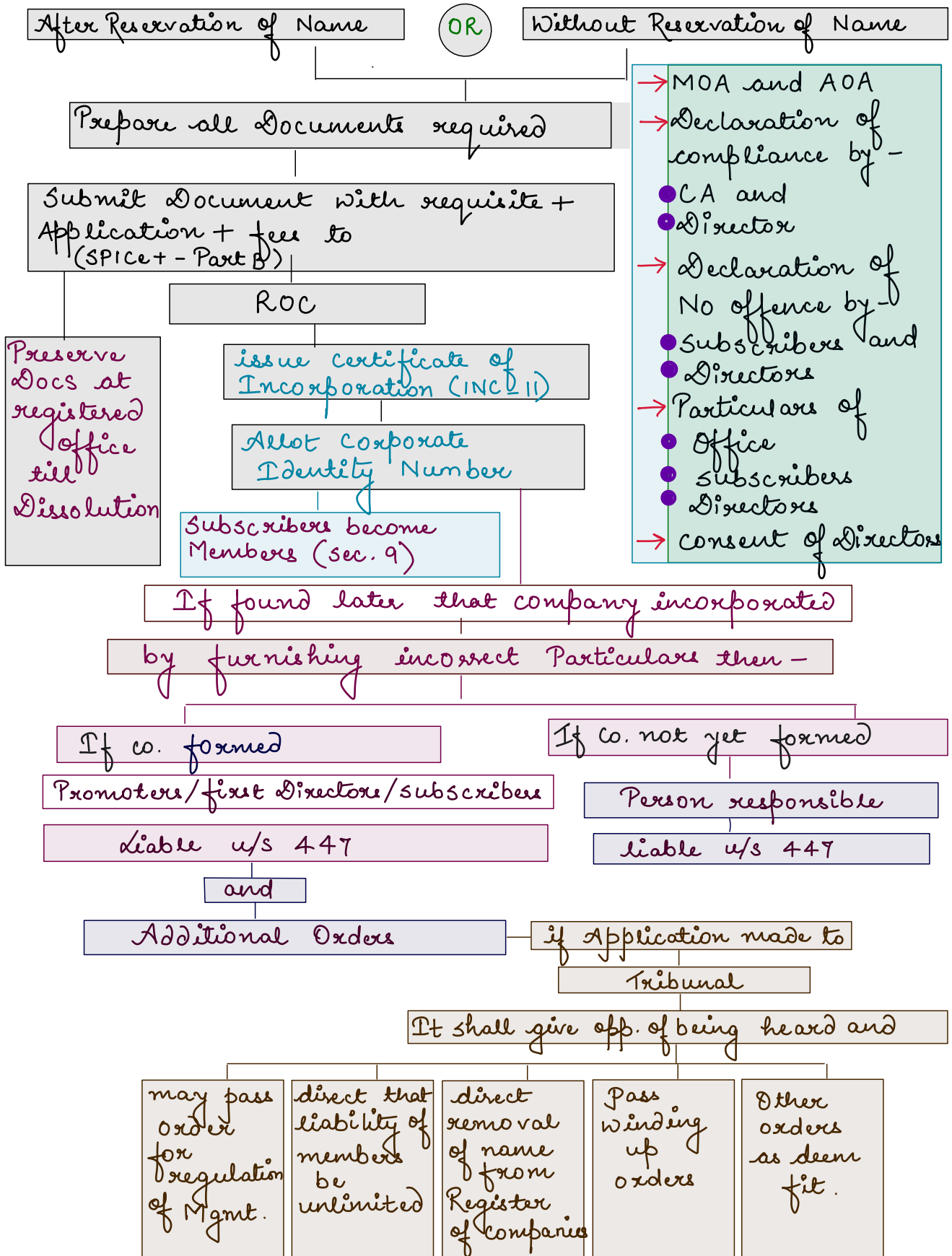

Commencement of Business [Section 10A]

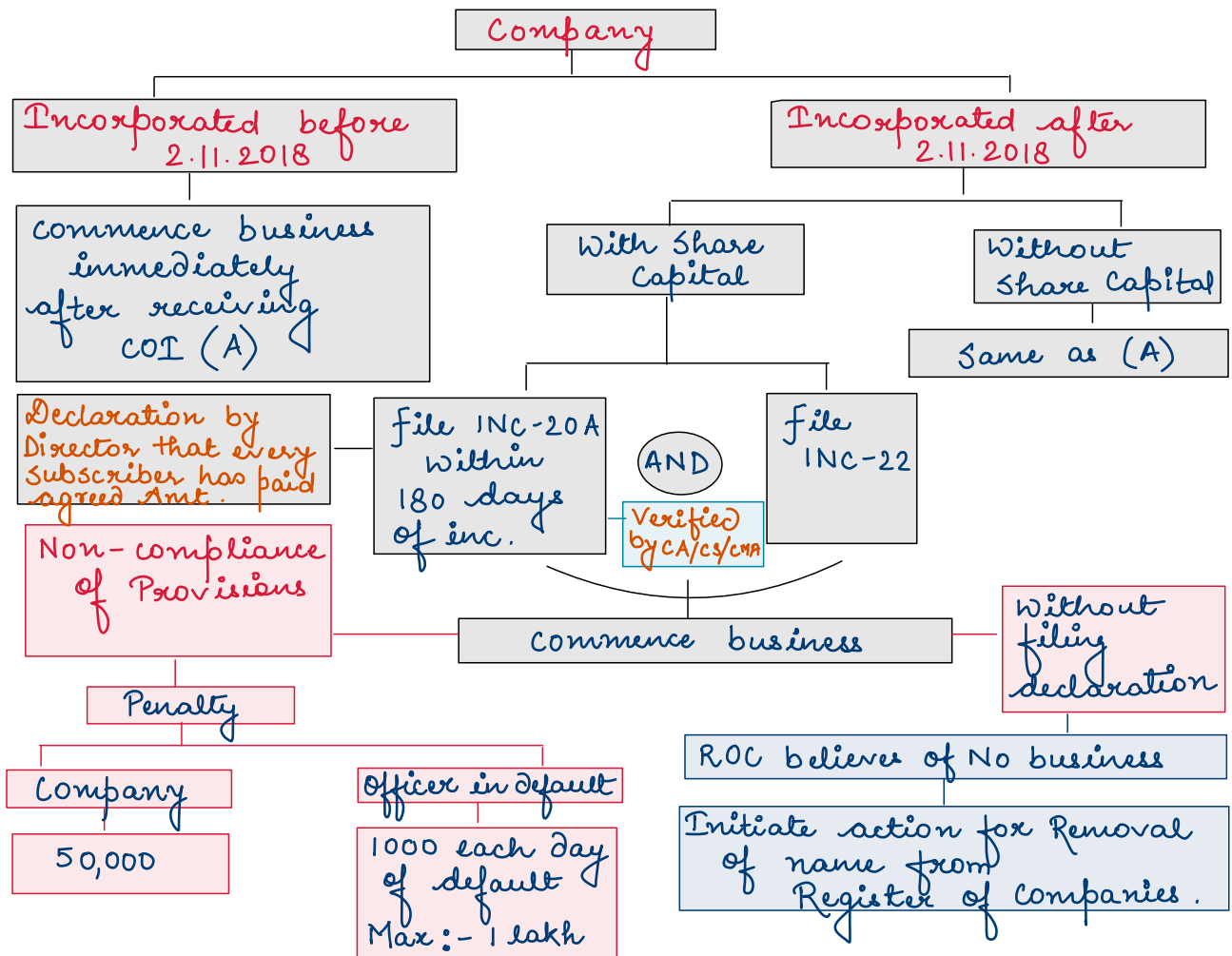

Publication of Name & Registered office [Section 12]

Affix name and address outside office in legible characters

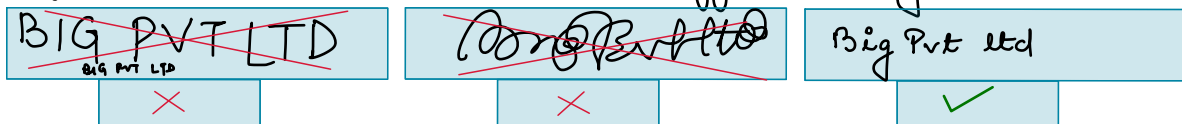

If Registrar has reasonable cause to believe

that company is not doing business

Registrar will do Physical Verification

Upon Verification

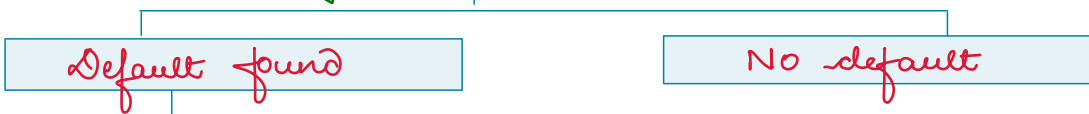

Registrar to remove name of company from Register

One Person Company Procedure of Incorporation

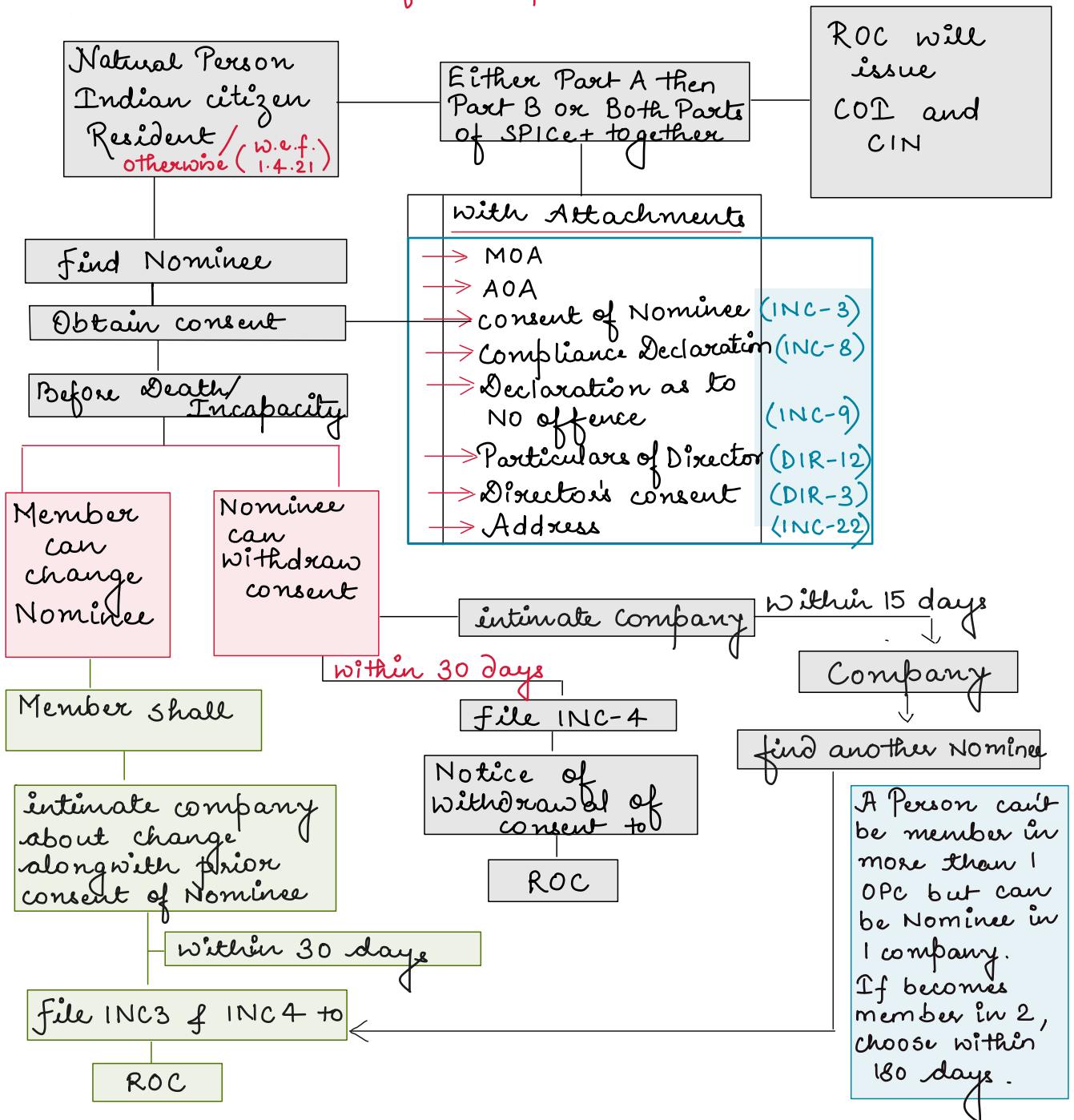

Conversion Of One Person Company

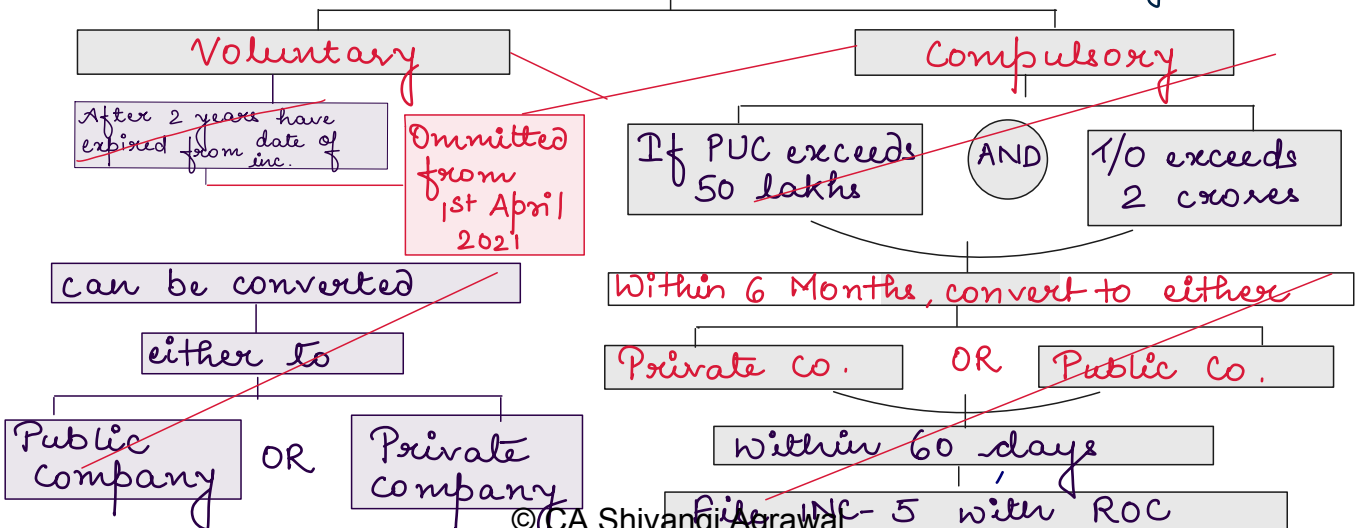

Conversion of OPC [Rule 6] w.e.f. 1st April 2021

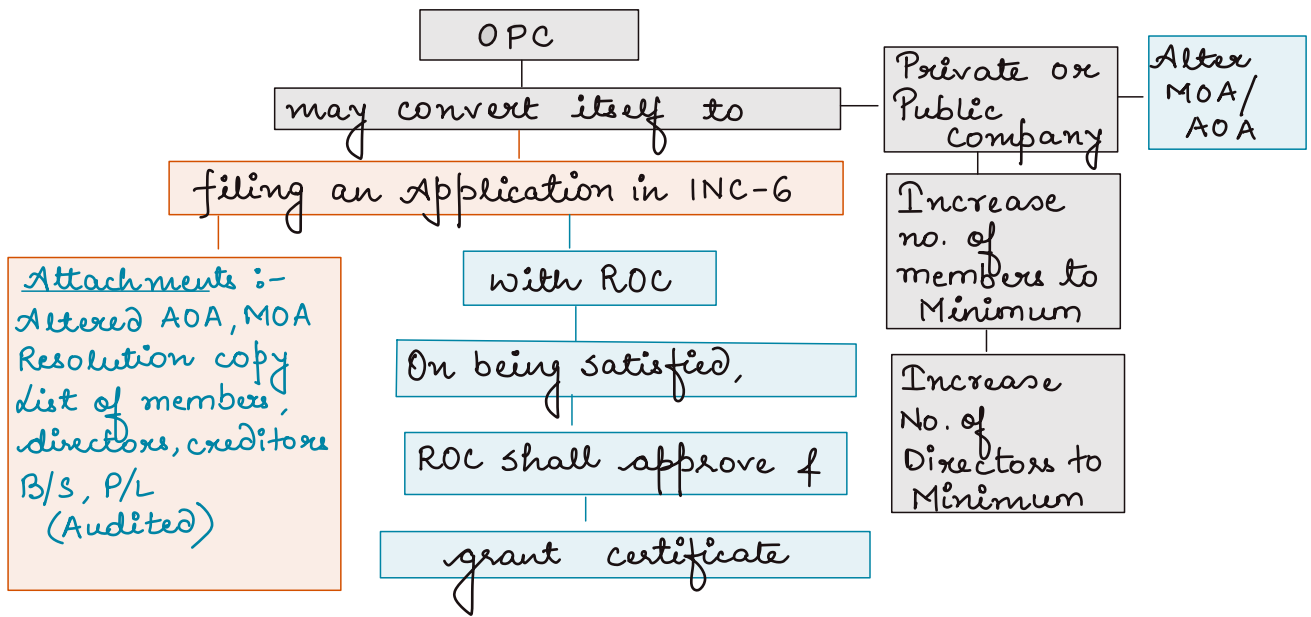

Section 8 Company Procedure of Incorporation

can be formed as Private/Public company

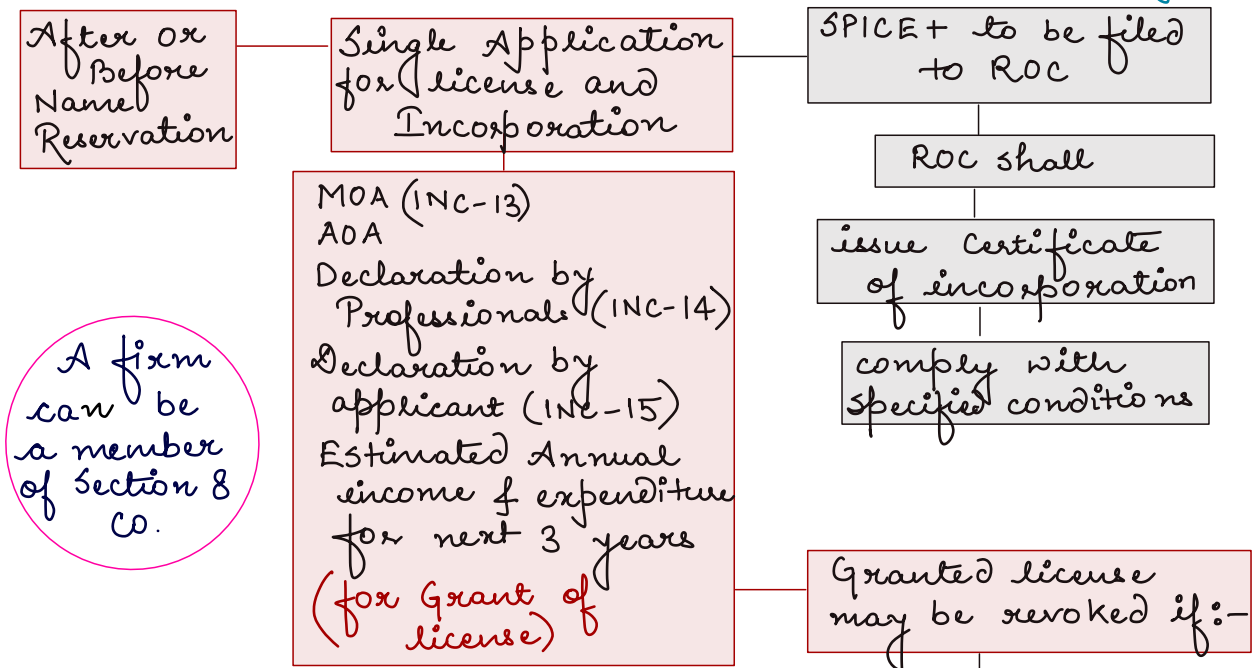

After giving an opportunity of being heard

- Contravention of requirements of Sec. 8
- Contravention of condition on which license was granted
- fraudulent conduct
- conduct in manner violative of objects
- conduct of affairs against Public Interest.

Copy of order to ROC

CG shall direct to convert status and Name after Revocation

CG may pass additional order like winding up if necessary in Public Interest.

Conversion of Section 8 Company

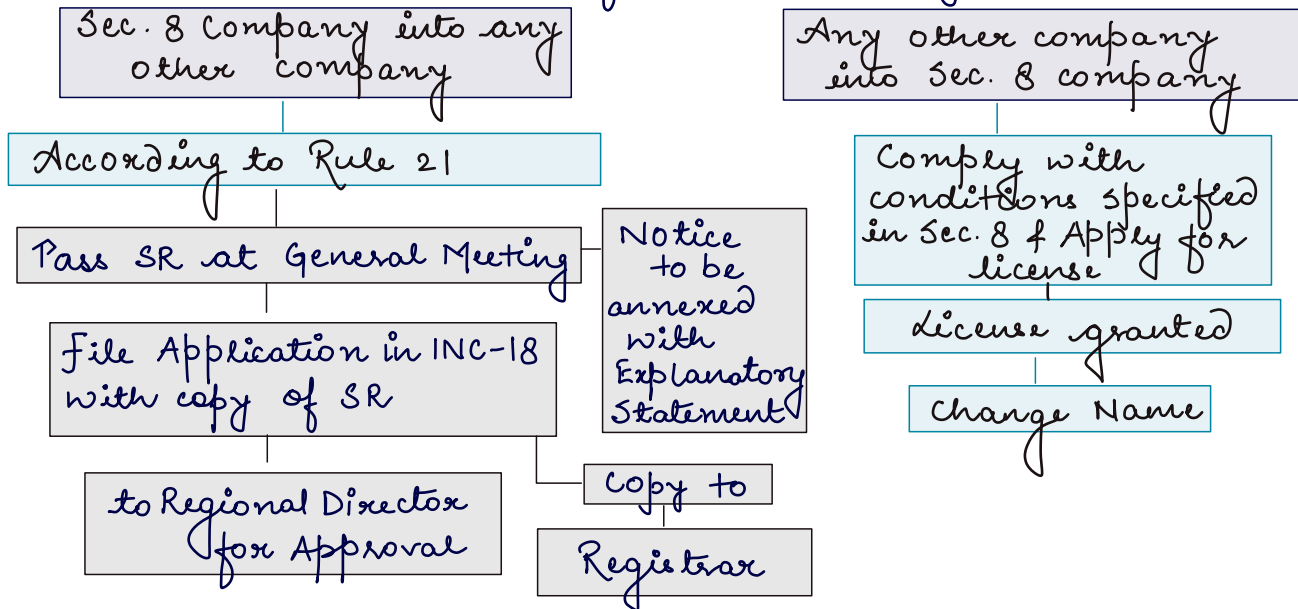

Alteration of Memorandum (Section 13)

① Alteration of Name Clause :-

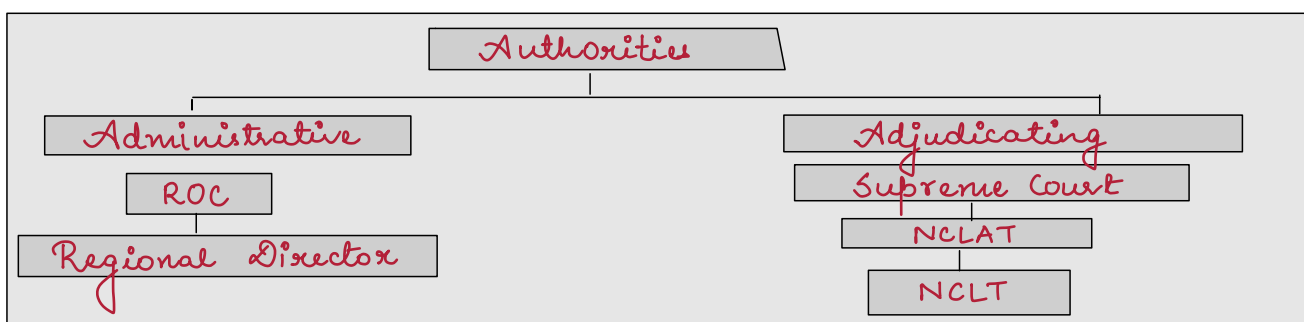
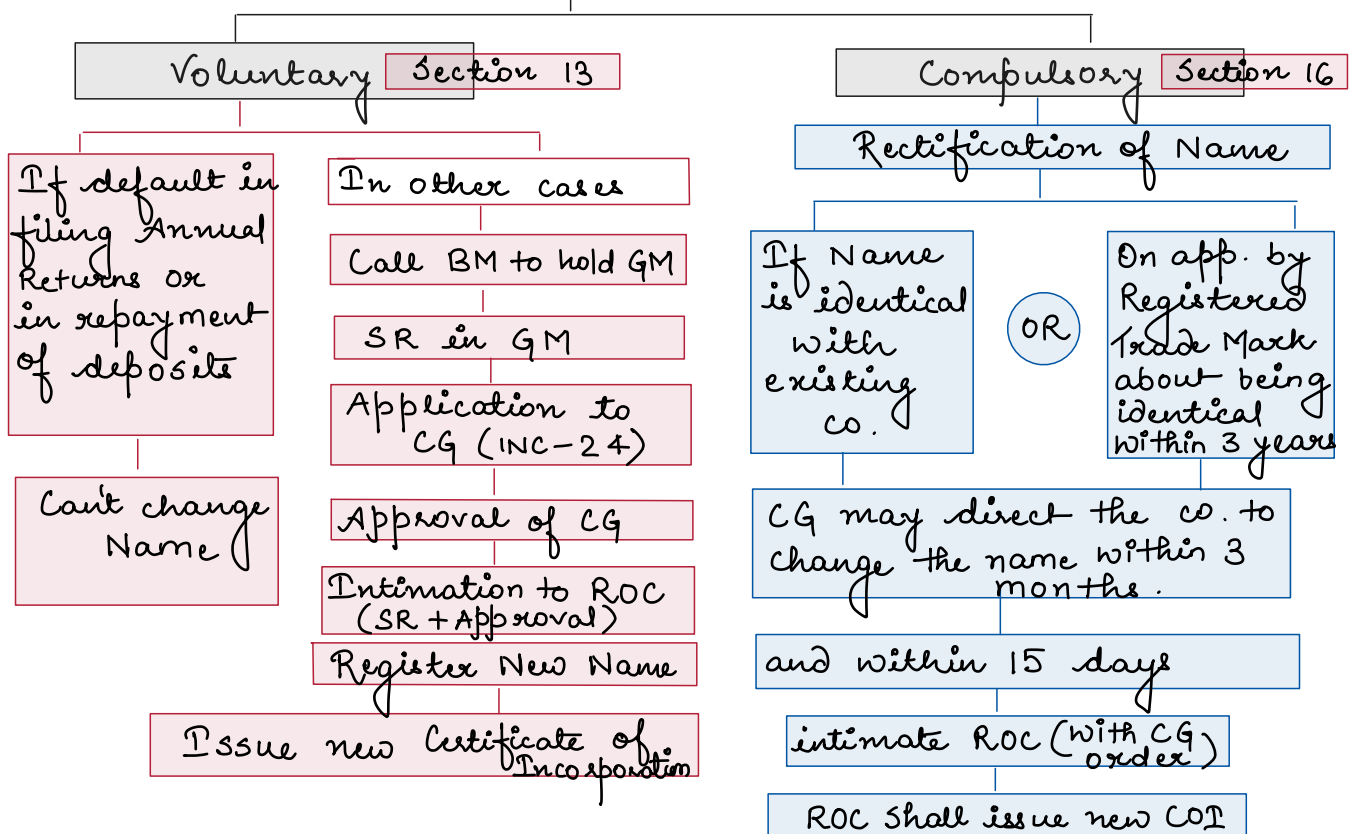

② Alteration to Situation Clause :-

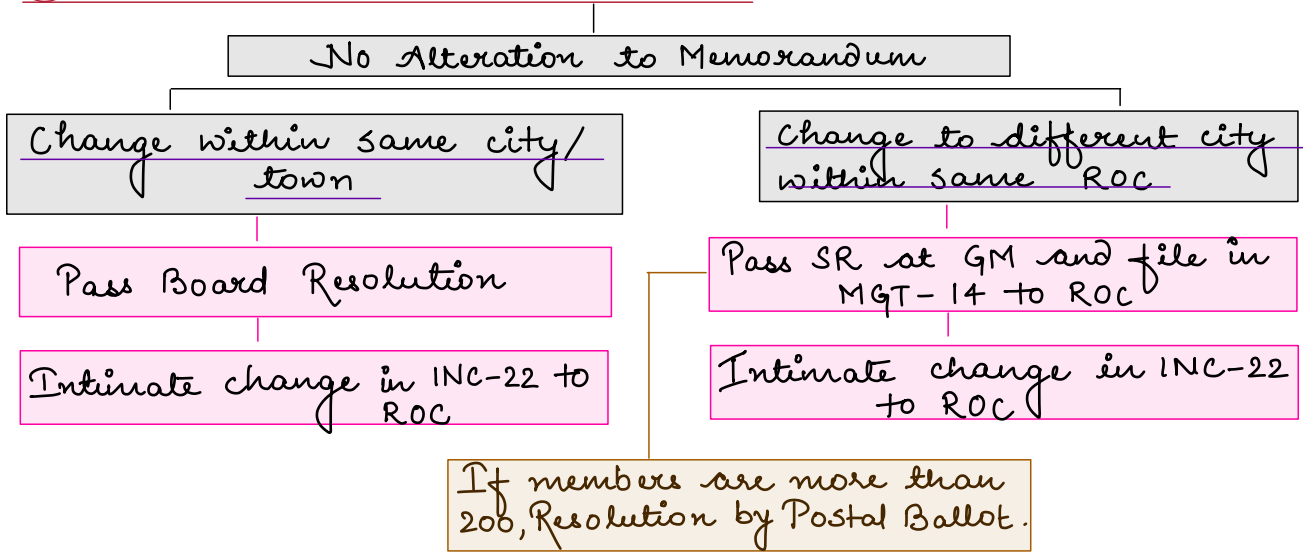

Change from one ROC to another within State

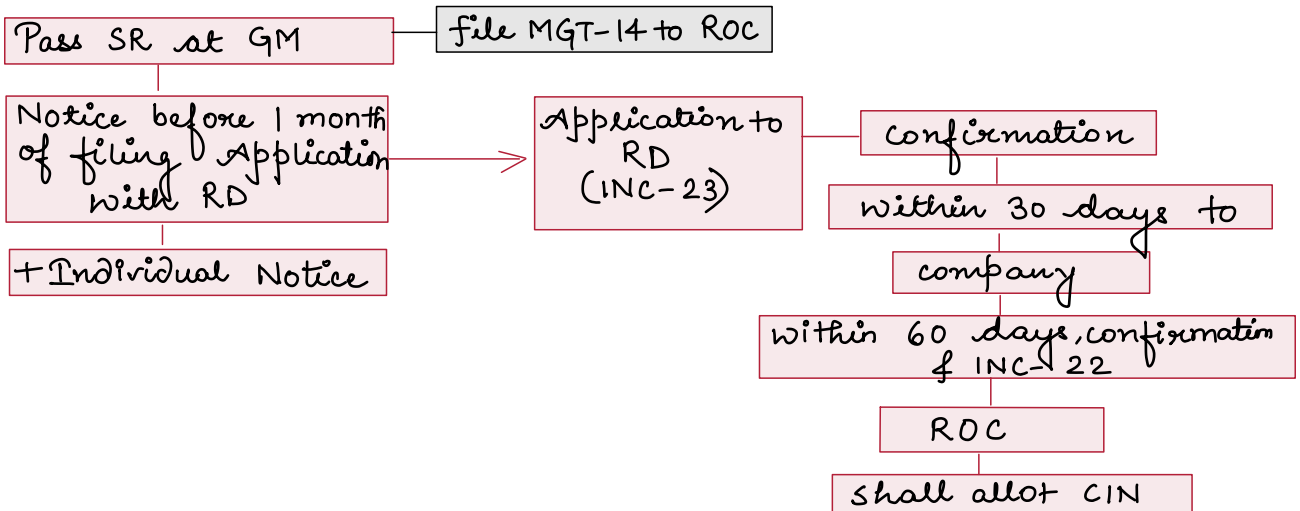

Change from one ROC to another outside State

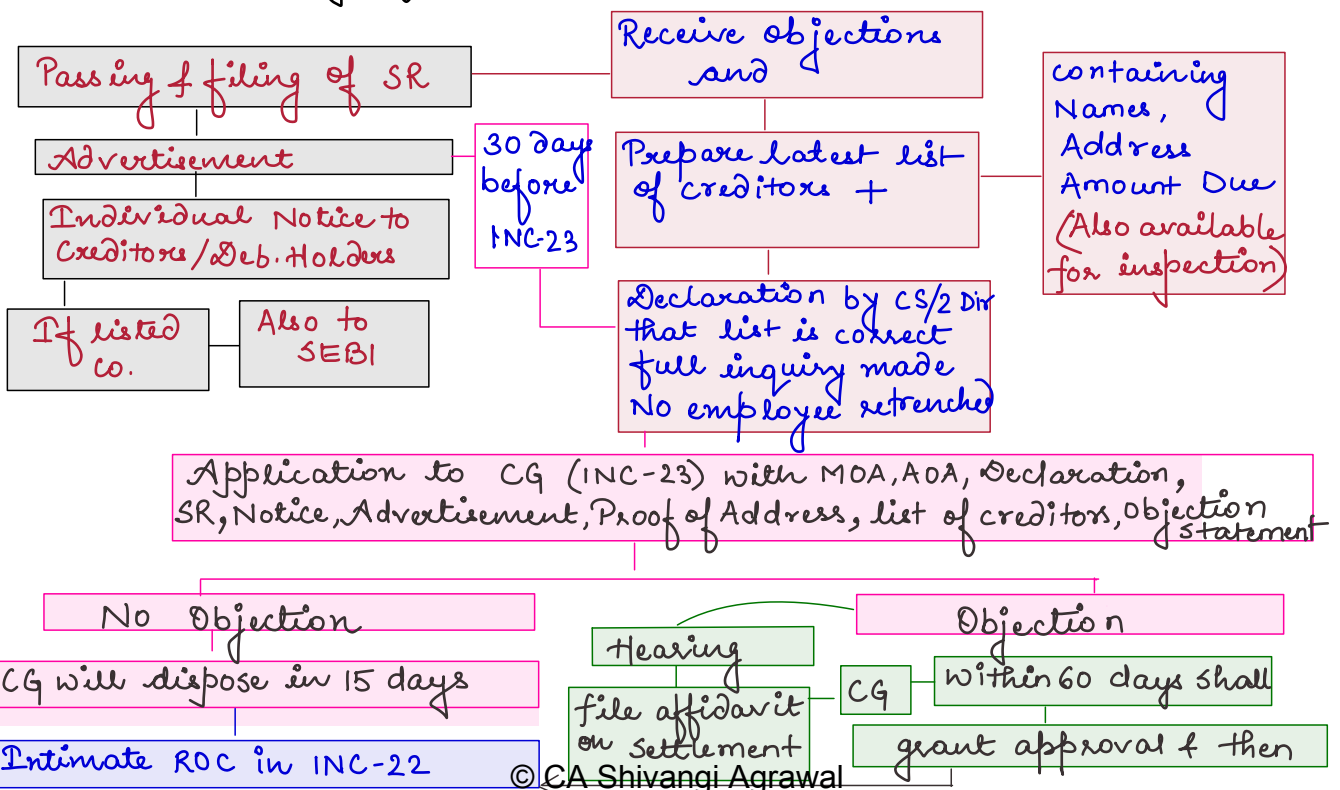

③ Alteration to Object Clause :-

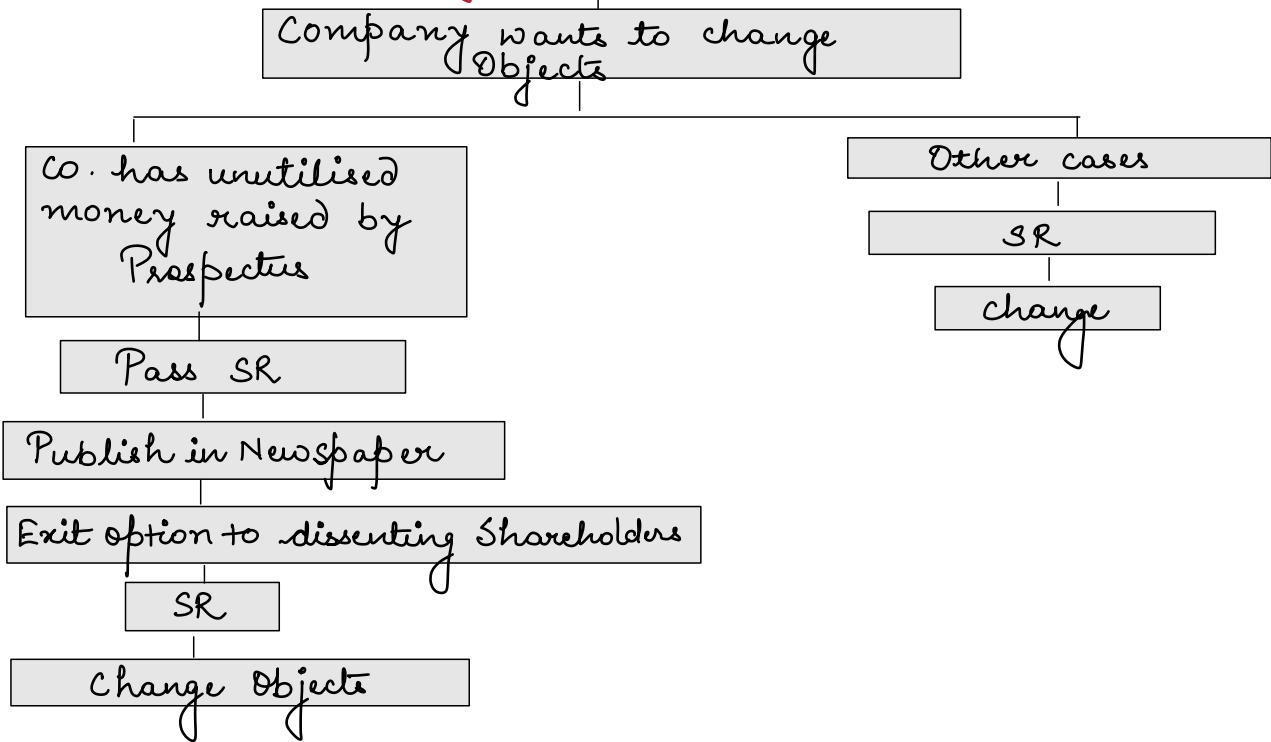

Alteration of Articles

Articles can be altered by passing Special Resolution

If

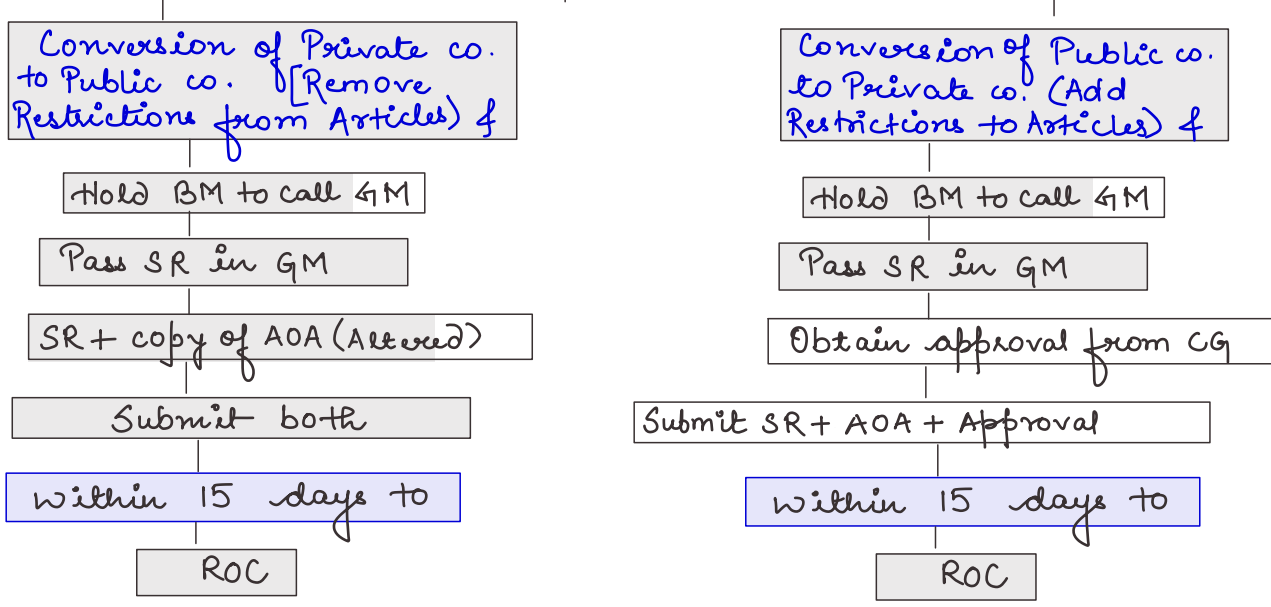

Effect of Memorandum & Articles [Section 10]

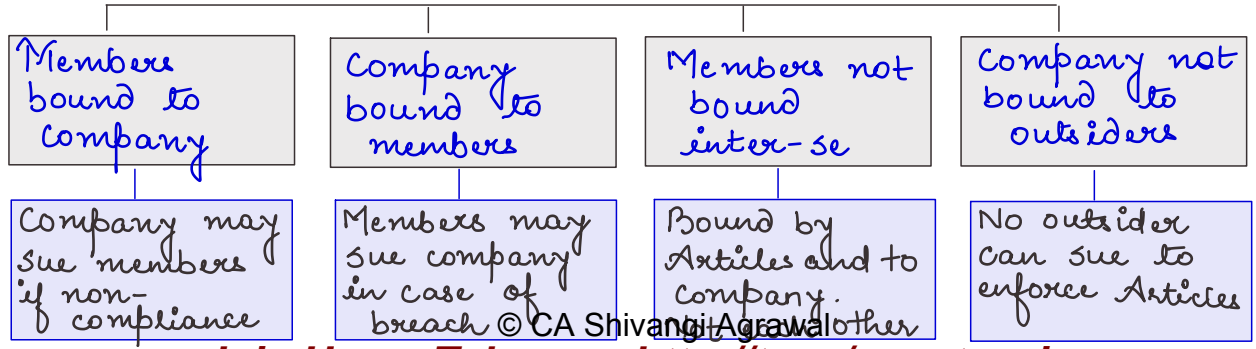

Prospectus & Allotment of Securities

Chapter III of Companies Act, 2013

Part - I

Part - II

containing Sections 23 - 41

containing Sec. 42

Public Offer

Private Placement

Issue of Securities (Section 23)

By Private Company

By Public Company

Private Placement

Rights issue

Bonus issue

Public offer

Rights issue

Bonus issue

Private Placement

By complying respective provisions

By complying resp. provisions

IPO

FPO

offer for sale

By complying Part - III of Chapter

By issuing prospectus (except underwriting/ repeat)

By complying with Part - I of

SEBI Act & Regulations in case of listed company.

Related section 40

Securities

Sec. 2(81) of Co.'s Act Says -

Not defined under Companies Act, 2013

According to Sec. 2(h) of SCRA, 1956, it includes :-

- Shares, stock, bonds, debentures
- Derivative
- Units by CIS
- Units by Mutual fund
- Instrument by SPV
- Government securities
- Security receipt acc. to SARFAESI
- As declared by CG
- Right/interest in Security

Prospectus

What?
[Sec 2(70)]

Any Document so described

- Red Herring
- Shelf
- Notice, circular, Advertisement inviting offer from Public.

Not an offer

but it is a prior stage of Invitation to offer.

Why?

Helps investors make informed decision.
Creates accountability and prevents fraud.

When?

When security is offered to Public

How?

Acc. to Companies Act and related rules.

Procedure of raising funds by issuing Securities

to Public through Prospectus

Known as

PUBLIC OFFER

Governing Laws:-

SCRA, SEBI Act, Companies Act

Application to one/More Stock Exchange for listing (Sec. 40)

Permission Granted by all

No Public Offer.

Not Granted by Anyone/All

Prepare Prospectus

Include Name of Stock Exchange

Send to ROC for filing (26)

Within 90 days

Give offer to Public with Application (33)

Receipt of Application Money

Money collected to be kept in separate A/c

Minimum Subscription Received

Yes

Allotment as per Sec. 39

Refund excess money

Now Money can be used

But No Variation in terms of contract

Other-wise Irregular Allotment

NO

Refund all money

How to Prepare?

- Golden Rule

What to include?

- Contents (Sec. 26)

If Incorrect.

- Misstatement

- Liability

Meaning, Types, Punishment

Allotment of Securities [Sec. 39]

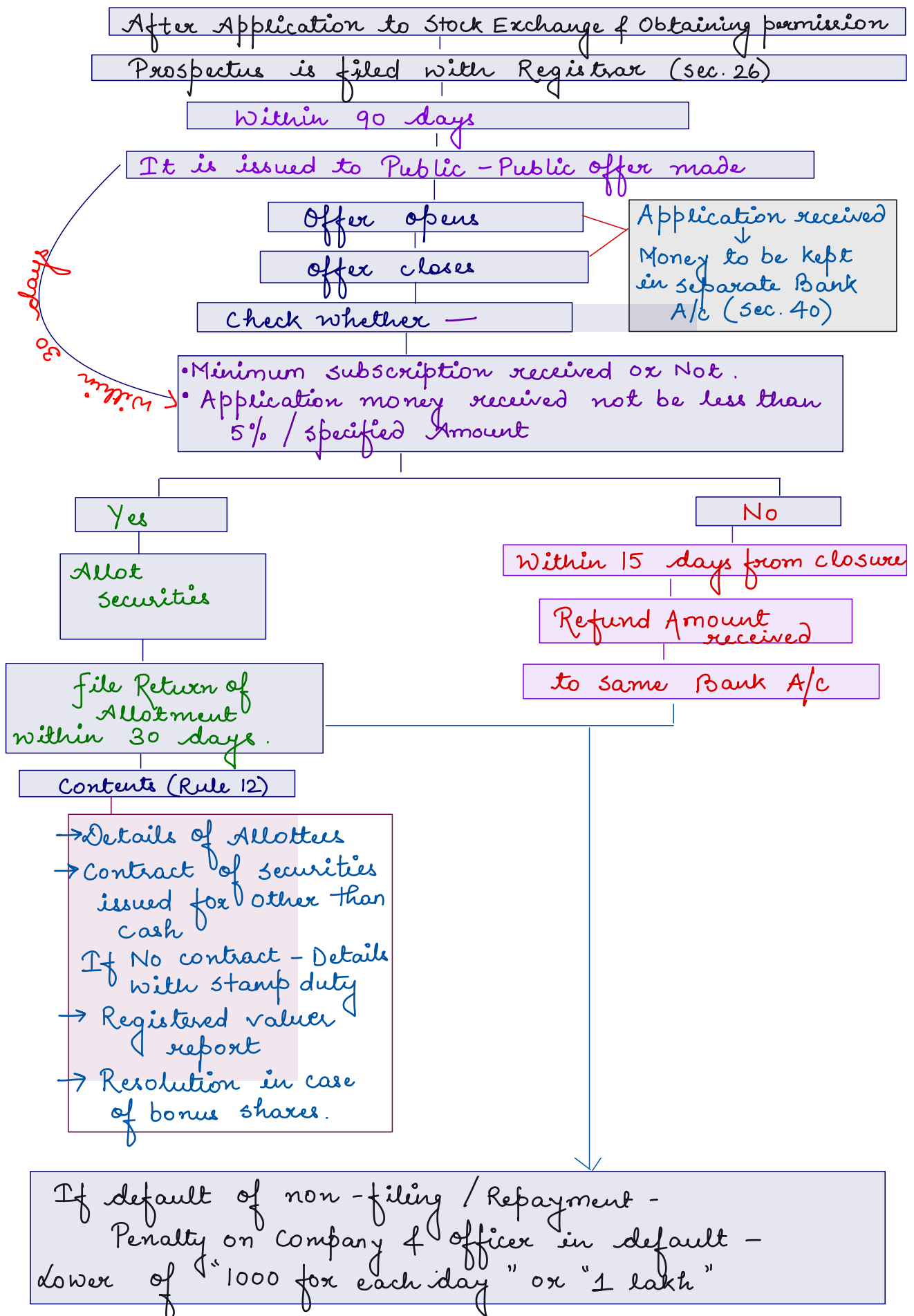

Cases of Irregular Allotment

Offer made without Prospectus

Prospectus doesn't include contents of Sec. 26

Prospectus issued w/o filing with Registrar

Allotment made w/o Minimum Subscription

Application money less than 5% or specified

Return of Allotment not filed

Offer made w/o obtaining permission from Stock Exchange.

Application money not kept in separate Bank A/c.

Section 26

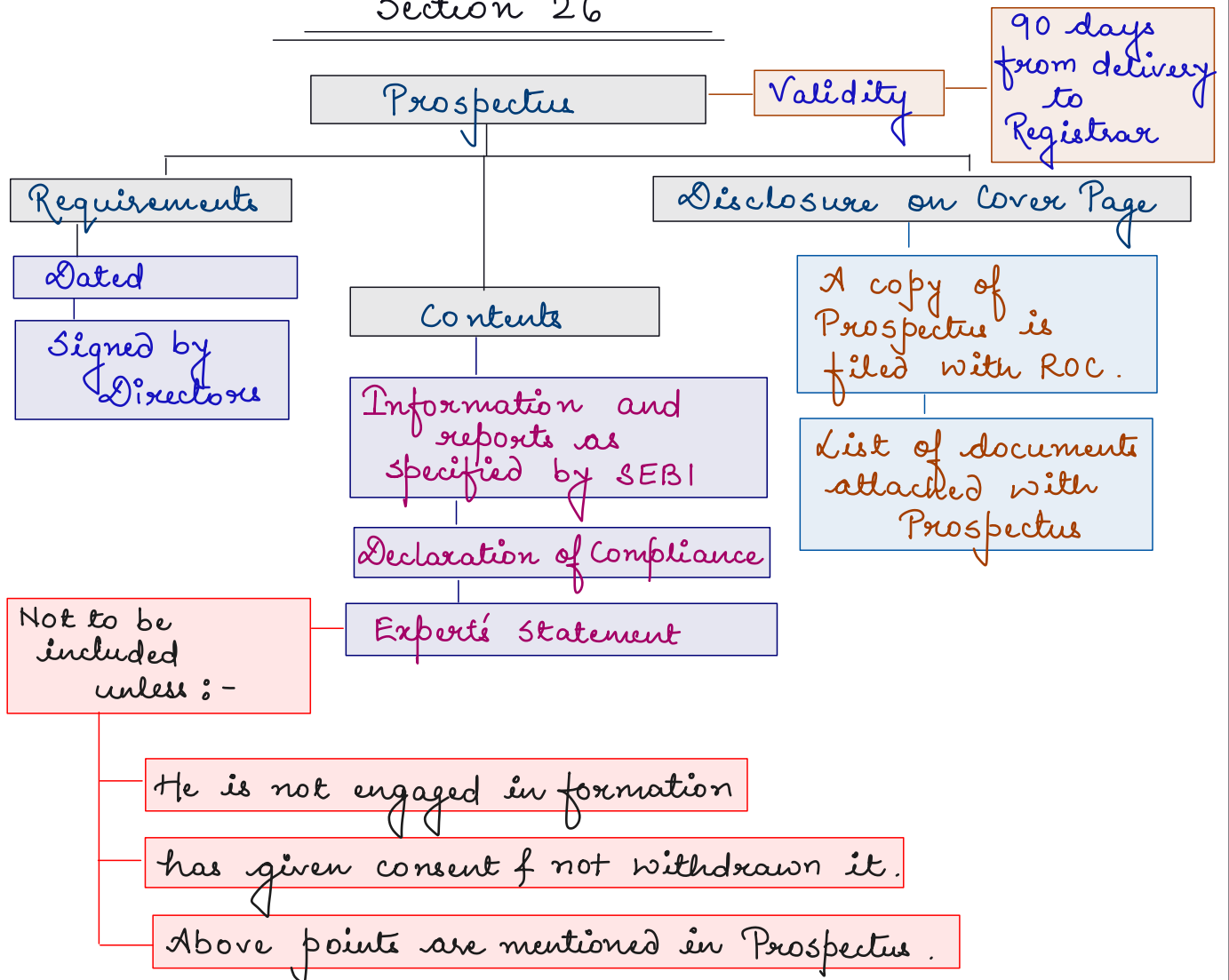

Punishment for Non-compliance of Sec. 26

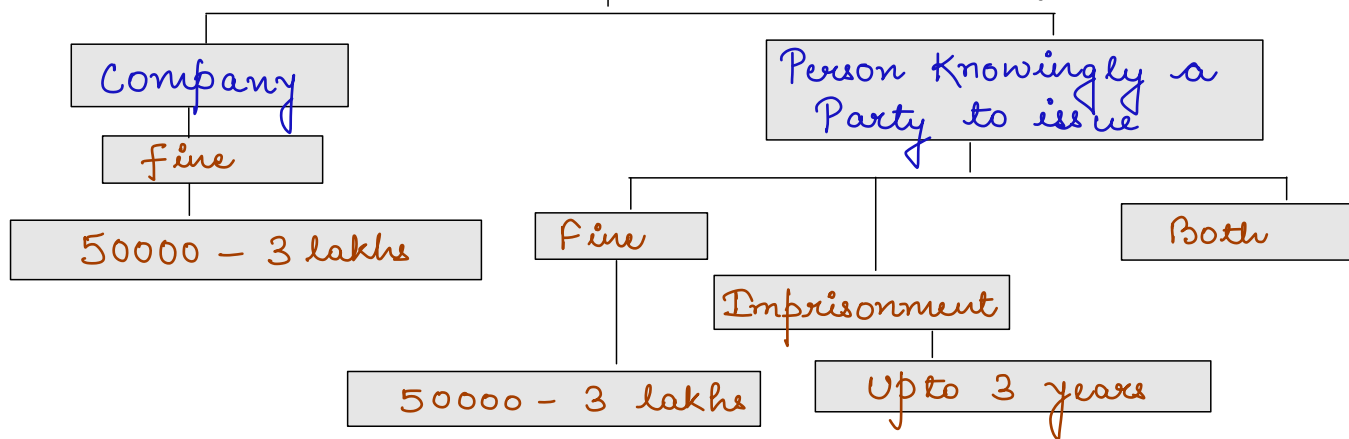

Golden Rule for framing Prospectus

Prospectus must disclose all material facts which are likely to influence decision of investors

It must be free from **Misstatements**

false / Inaccurate Info

either due to commission

or omission or both

It is a serious offence and attracts **Penalty**

Civil liability u/s 35

Loss or Damage - Essential

Code of Civil Procedure

offence against Party

Company, Director, Proposed Director, Promoter, expert, one who authorised is liable to

Pay compensation to investors

Defences

Withdrew consent to be director

Believed on expert's consent

Prospectus issued w/o knowledge

Criminal liability u/s 34

Mens Rea is essential

Under code of Criminal Procedure

Offence against State

Person who authorised prospectus

Punishable u/s 447

Defences

Immaterial

Reasonable ground to believe

Punishment for fraud [Sec. 447]

Section 447 is attracted in case of **FRAUD**

act, omission, concealment, abuse committed with intent to deceive to gain undue advantage or injure interest of shareholders, creditors etc. whether or not there is —

Punishment for fraud

If it involves Public interest

It does not involve Public interest

Fine

and

Imprisonment

Min - Amount of fraud
Max - 3 times of fraud

Min - 3 years
Max - 10 years

Wrongful Gain

OR

Wrongful loss

Gain by unlawful means of property to which person is not legally entitled

Loss by unlawful means of property to which person is legally entitled.

(A) lower of -
1% of turnover
OR
10 lakhs

If Amount of fraud is less than (A)

If Amount of fraud is more than/equal to (A)

Fine

And/
OR

Imprisonment

Max = 50 lakhs

Max = 5 years

Fine

AND

Imprisonment

Min = Amount of fraud
Max = 3 times of fraud

Min = 6 Months
Max = 10 years

Abridged Prospectus

Memorandum containing salient features of Prospectus as specified by SEBI

Form of Application to be accompanied by Abridged Prospectus (Sec. 33)

Shelf Prospectus (Section 31)

Prospectus which does not require to be re-issued for one or more issues over a certain period

For specified class of Company of Security

Validity = 1 year

Information Memorandum

PAS-2

1 month prior to issue of subsequent offer

Contents :-
New Charges
Change in financial position
Other prescribed changes

Effect :-
Shelf Prospectus +
Memorandum =
Prospectus

Filing of Shelf Prospectus

First issue

file Memorandum 2nd issue

file Memorandum 3rd issue

opening of offer Date

Closing of offer

Validity starts of 1 year

If Person makes advance payment → before change of Memorandum
Intimate to such person ← Company
Agree ✓ Disagree → Refund within 15 days.

Red Herring Prospectus (Sec. 32)

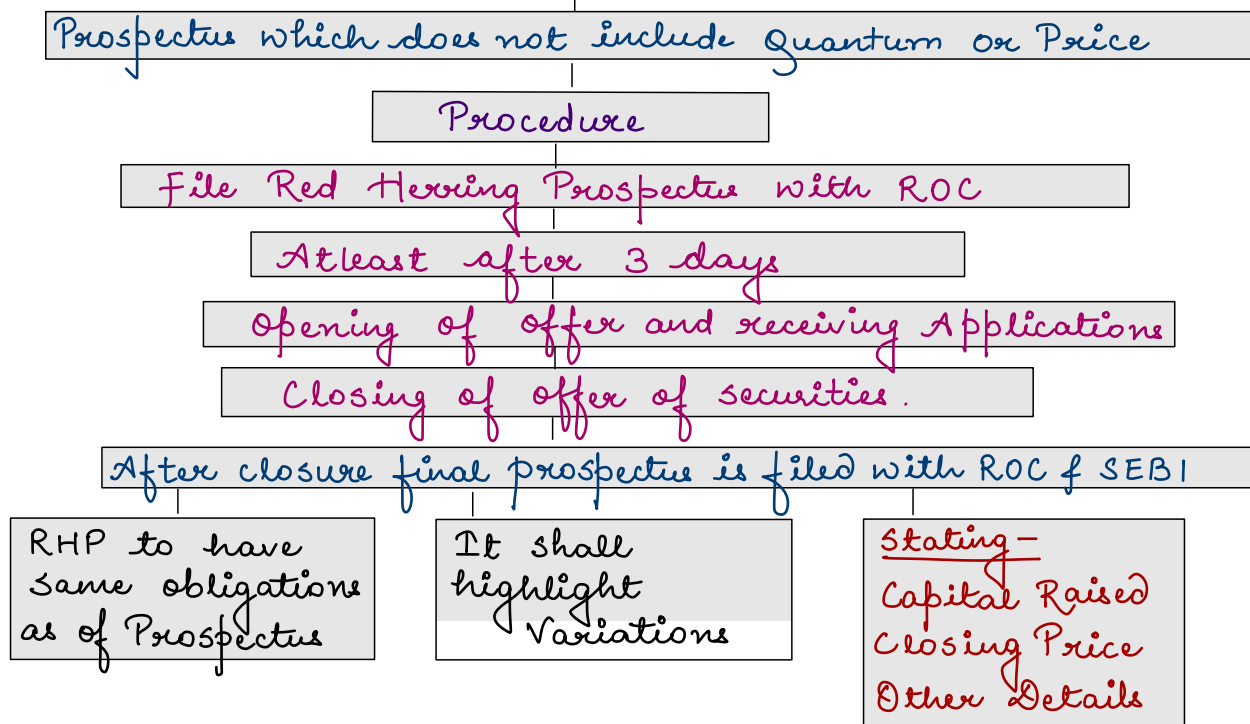

Deemed Prospectus (Section 25)

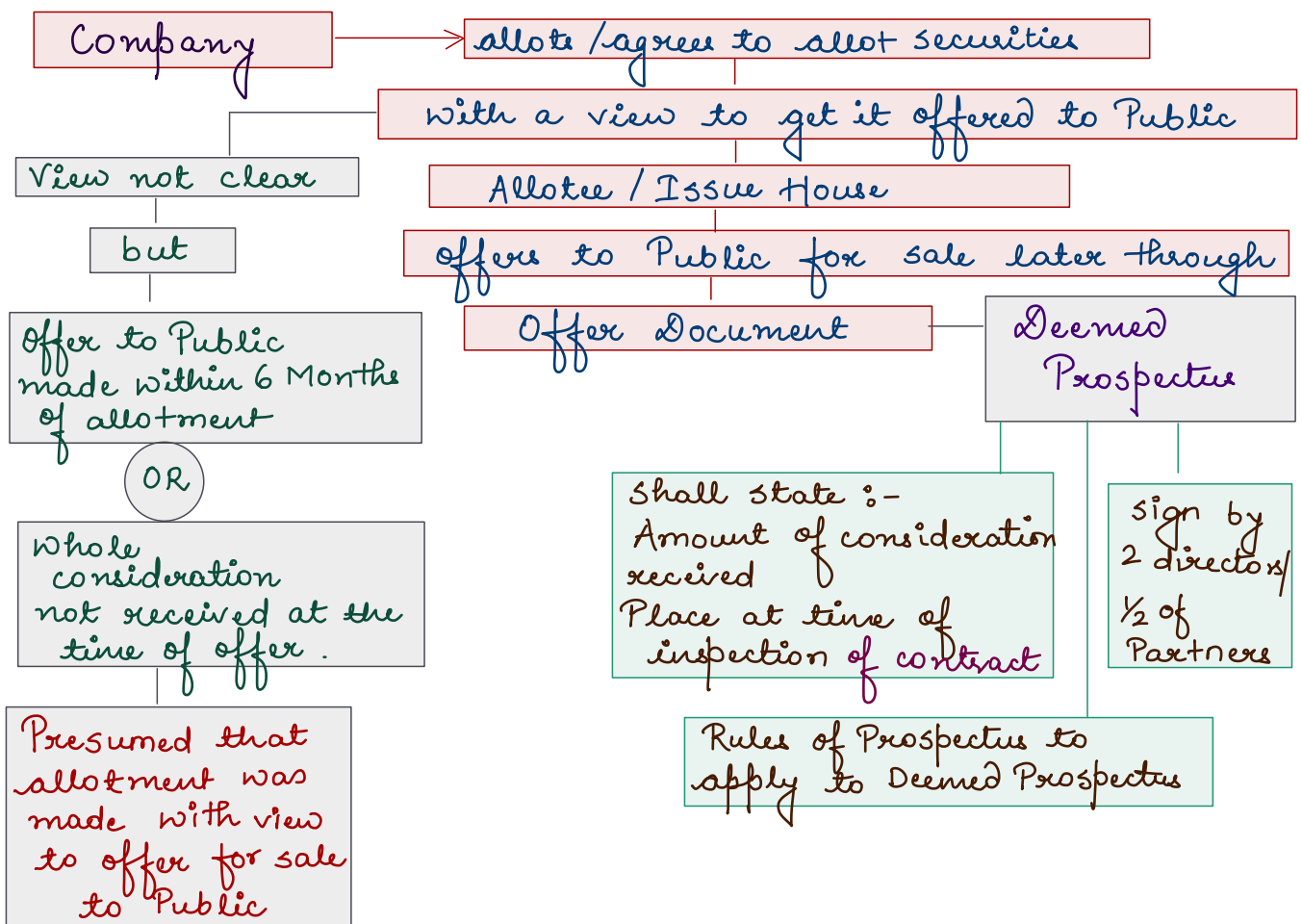

Deemed Prospectus [Sec. 28]

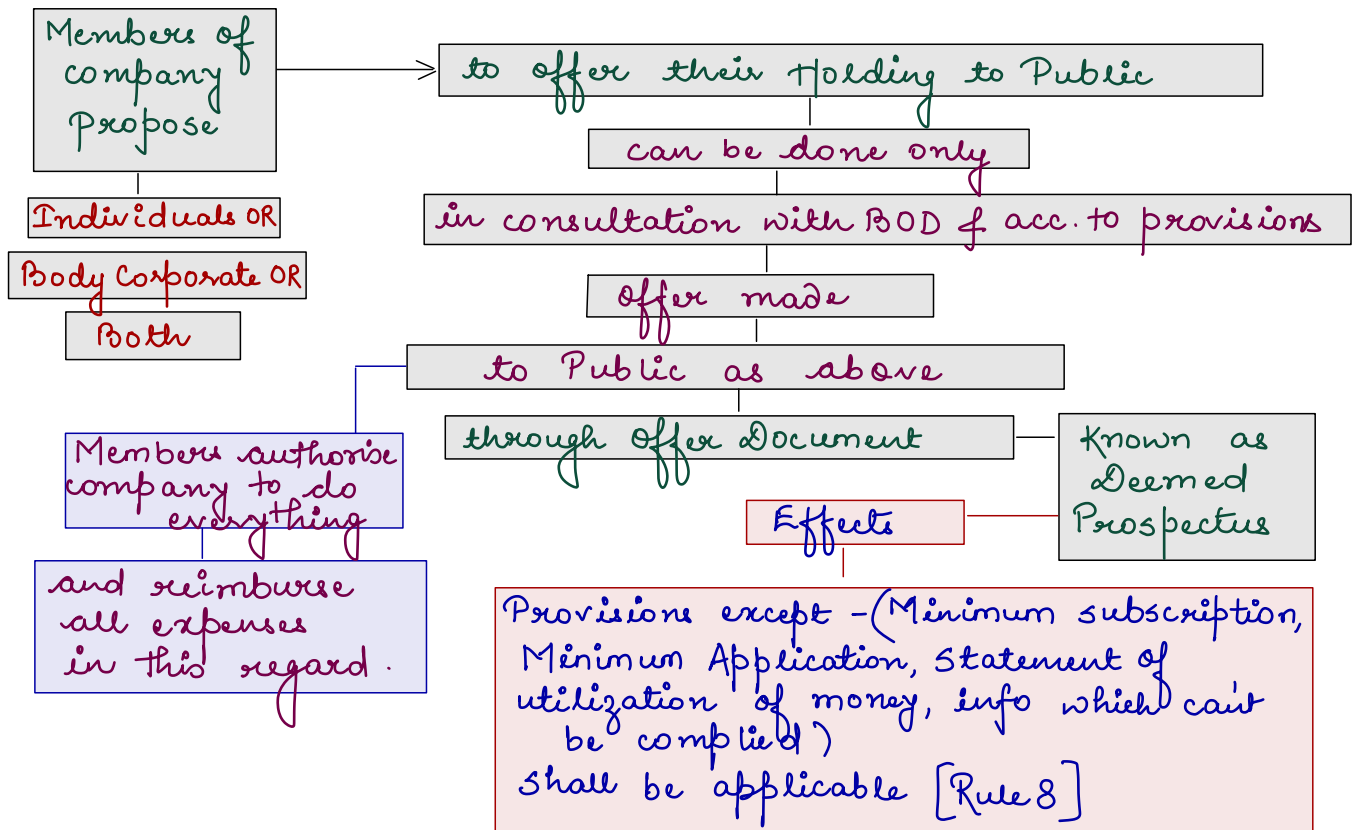

Fraudulently inducing to invest (Sec. 36)

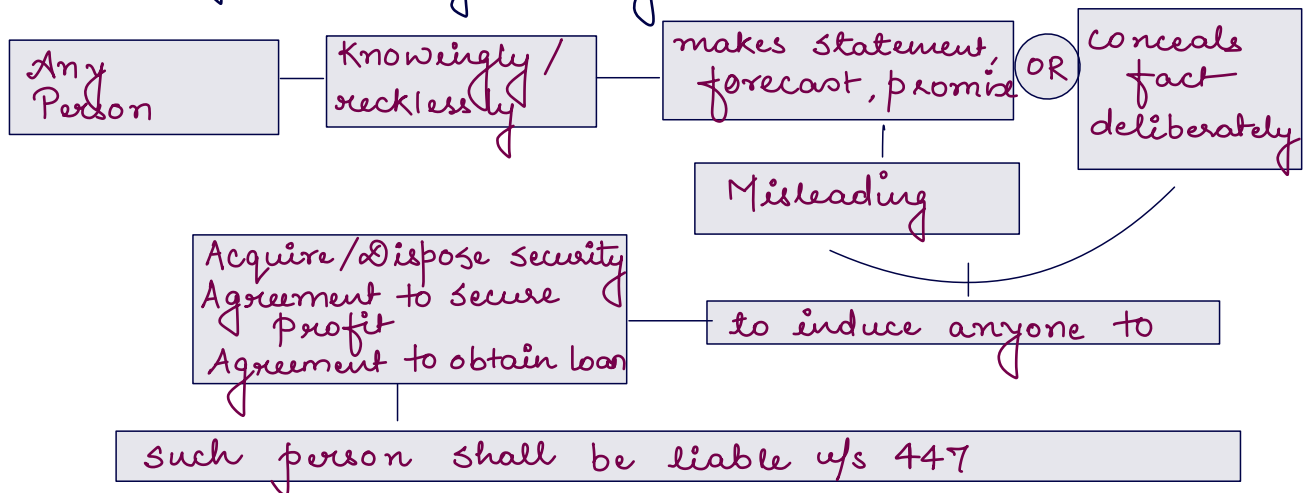

Class Action (sec. 37)

Allowed for action u/s 34, 35, 36. (Group Action by Cost effective for small investors. Investors)

Advertisement (sec. 30)

Specify - Objects - Share capital
 - liability - Signatories (Name & shares subscribed)
 - Capital structure.

Variation in terms of Contract (Sec. 27)

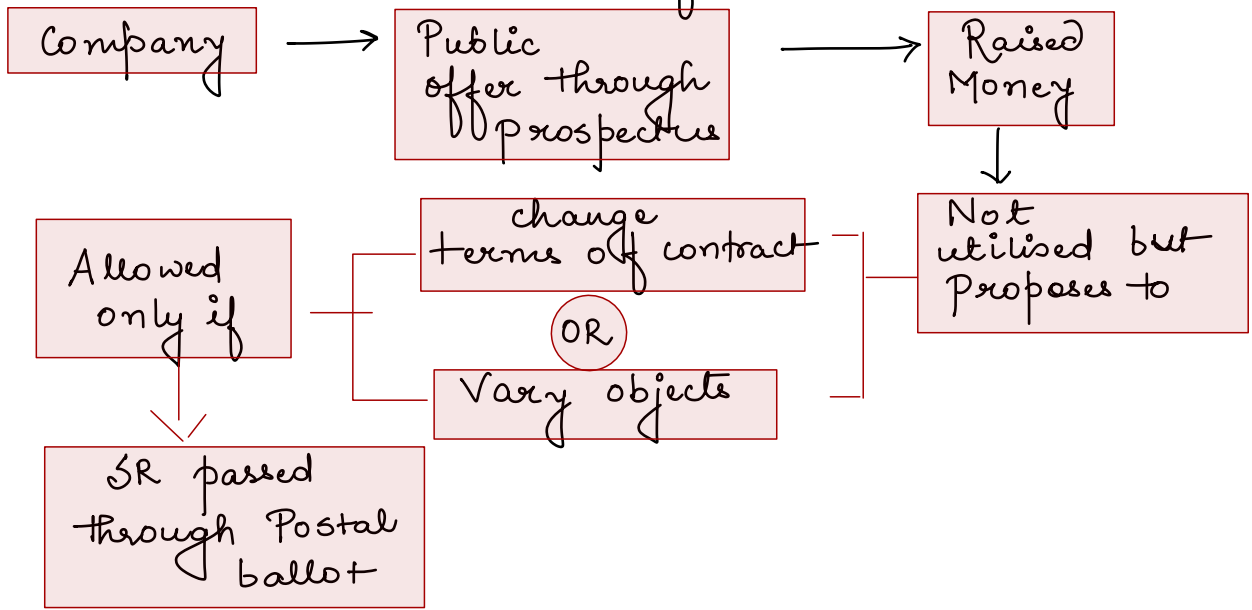

Advertisement of Variation to be published in form PAS-1 in Notice Newspaper Company's website

Securities in Demat form (Sec. 29)

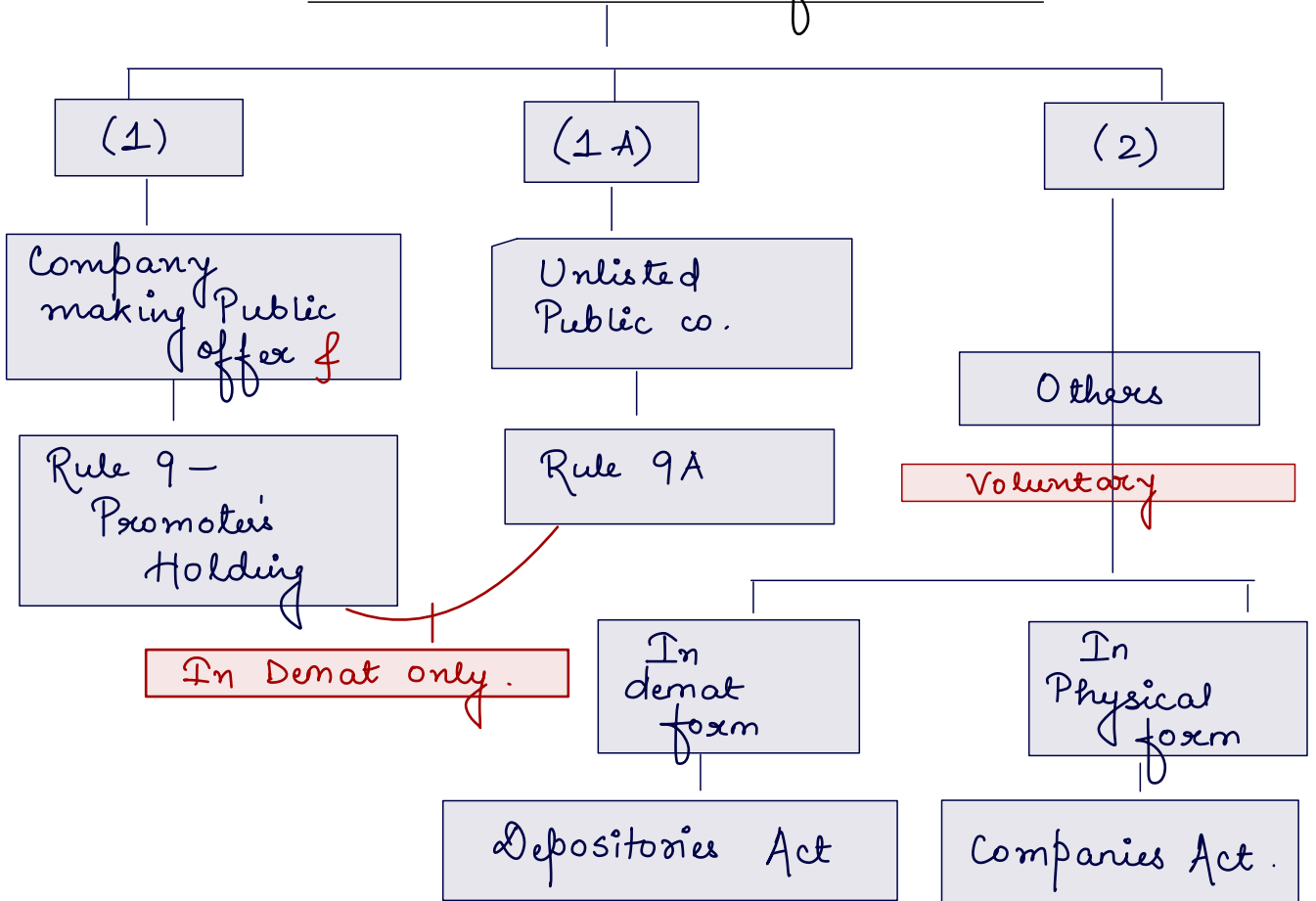

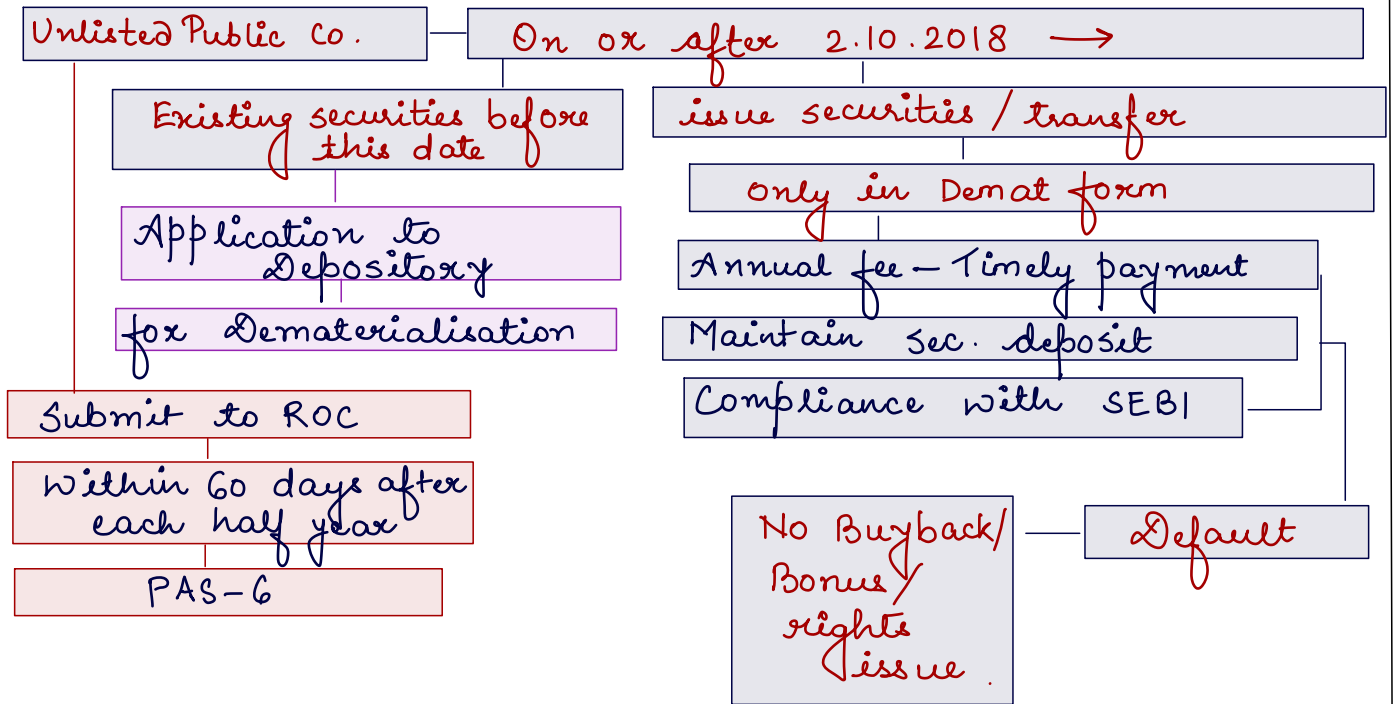

Underwriting Commission (Sec.40)

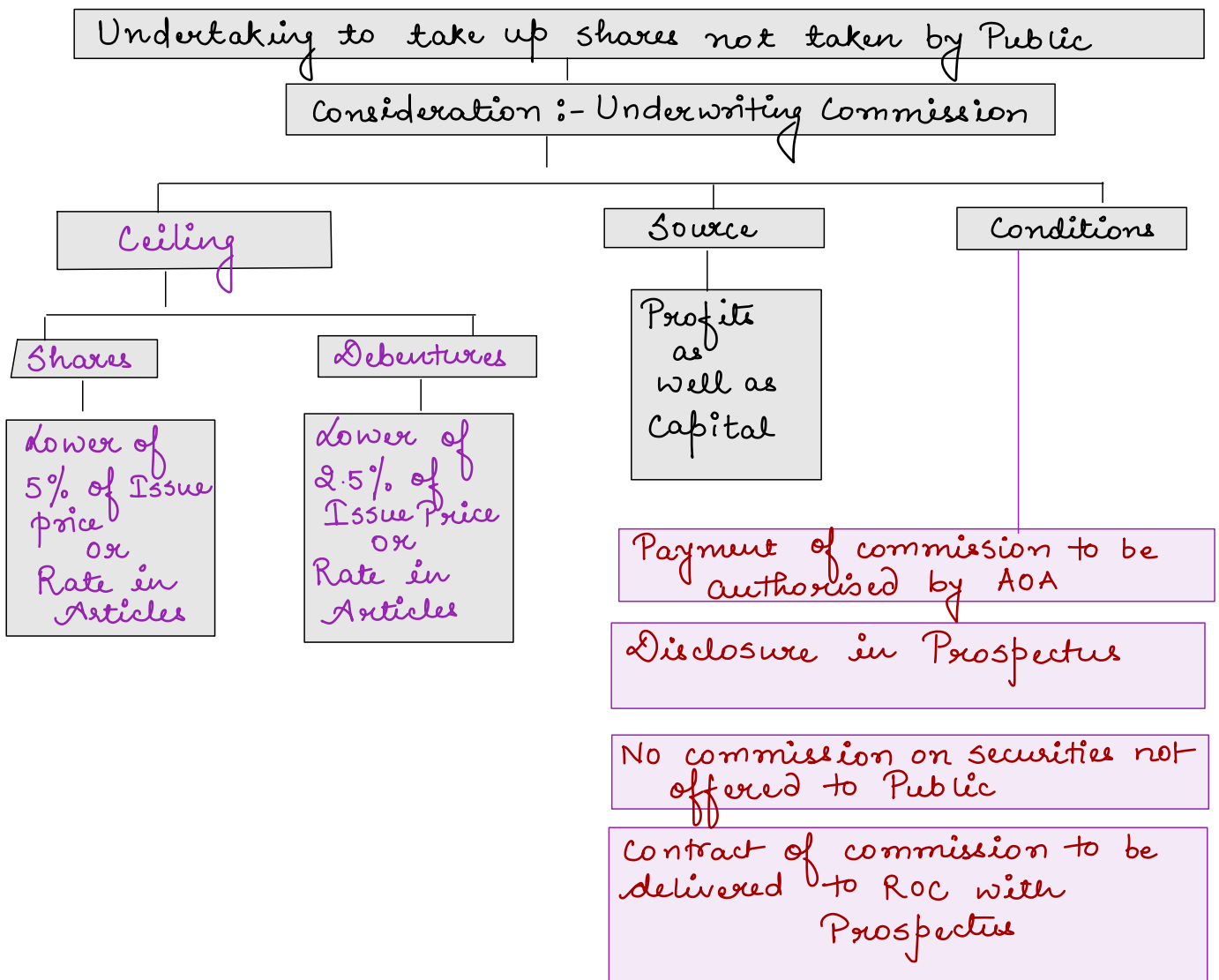

Private Placement (Sec. 42) - Rule 14

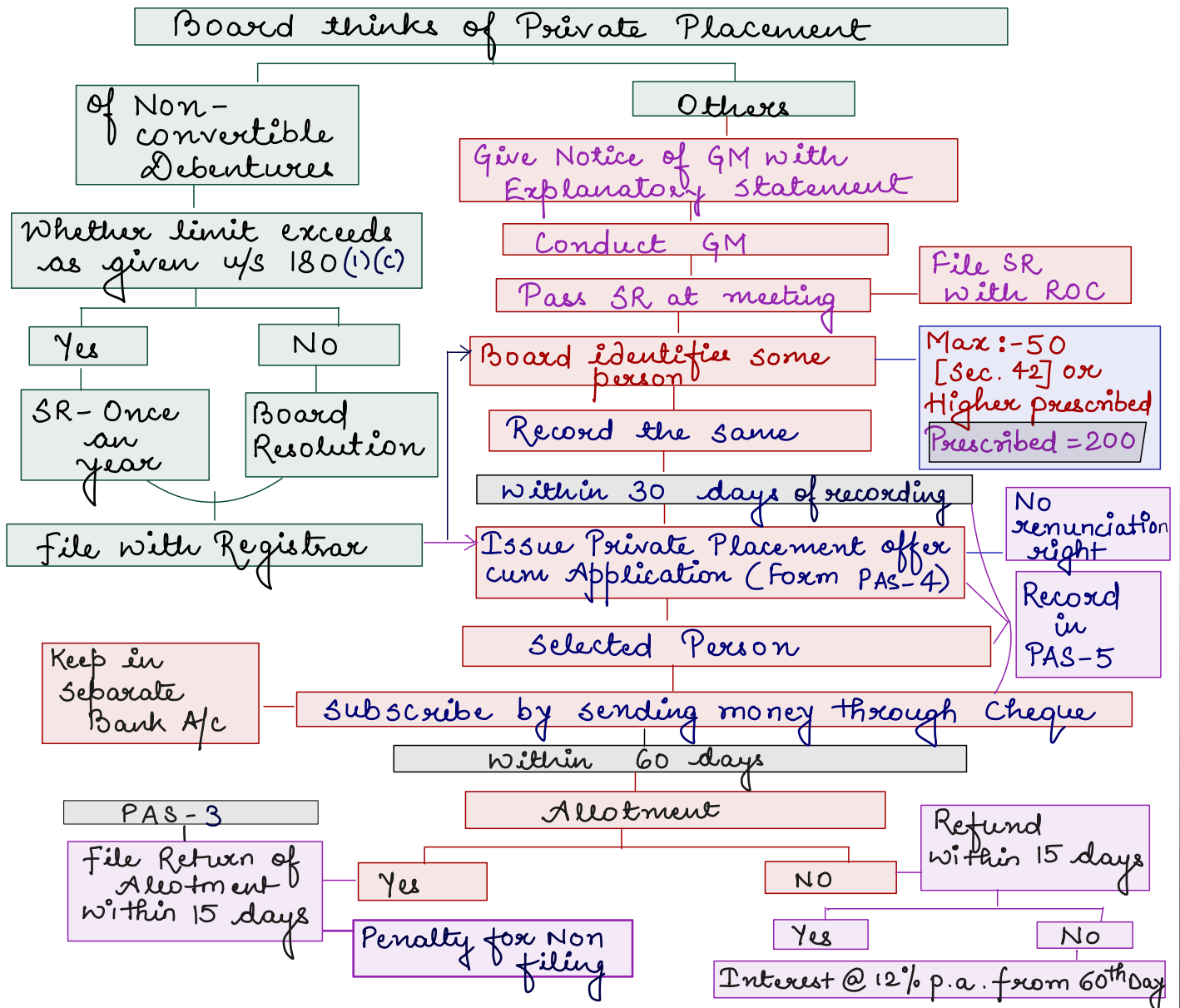

Other Points related to Private Placement

No new offer unless allotment completed/abandoned.
 No Public Advertisement

Share Capital and Debentures

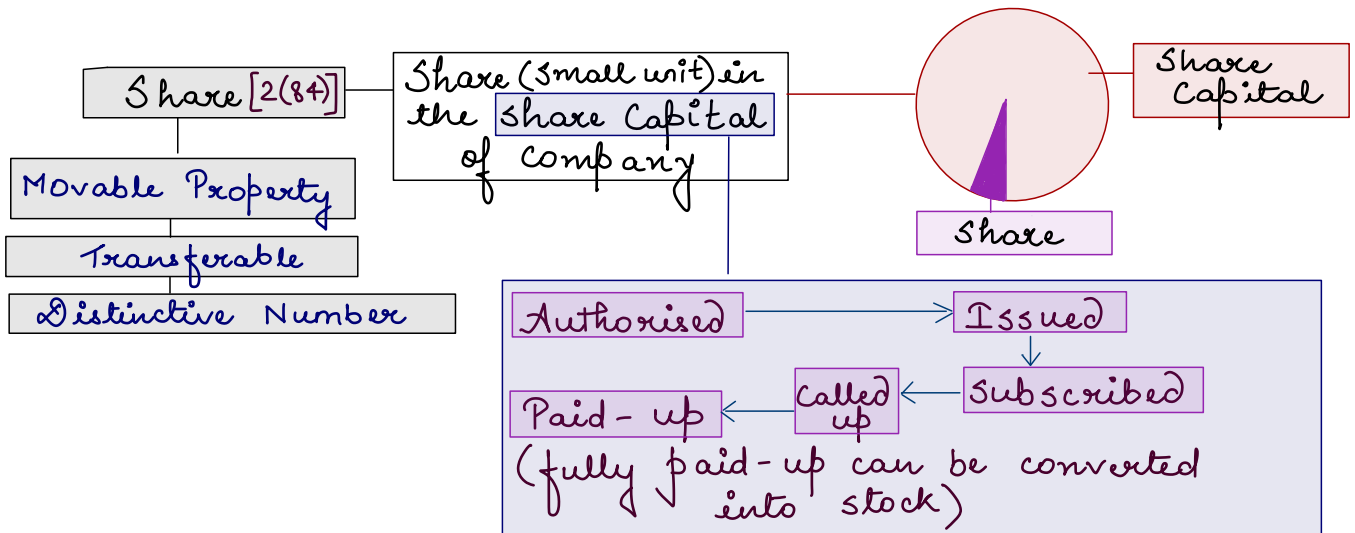

Kind of Shares [Sec. 43]

N.A. to Private Company if Memorandum/Articles say so.

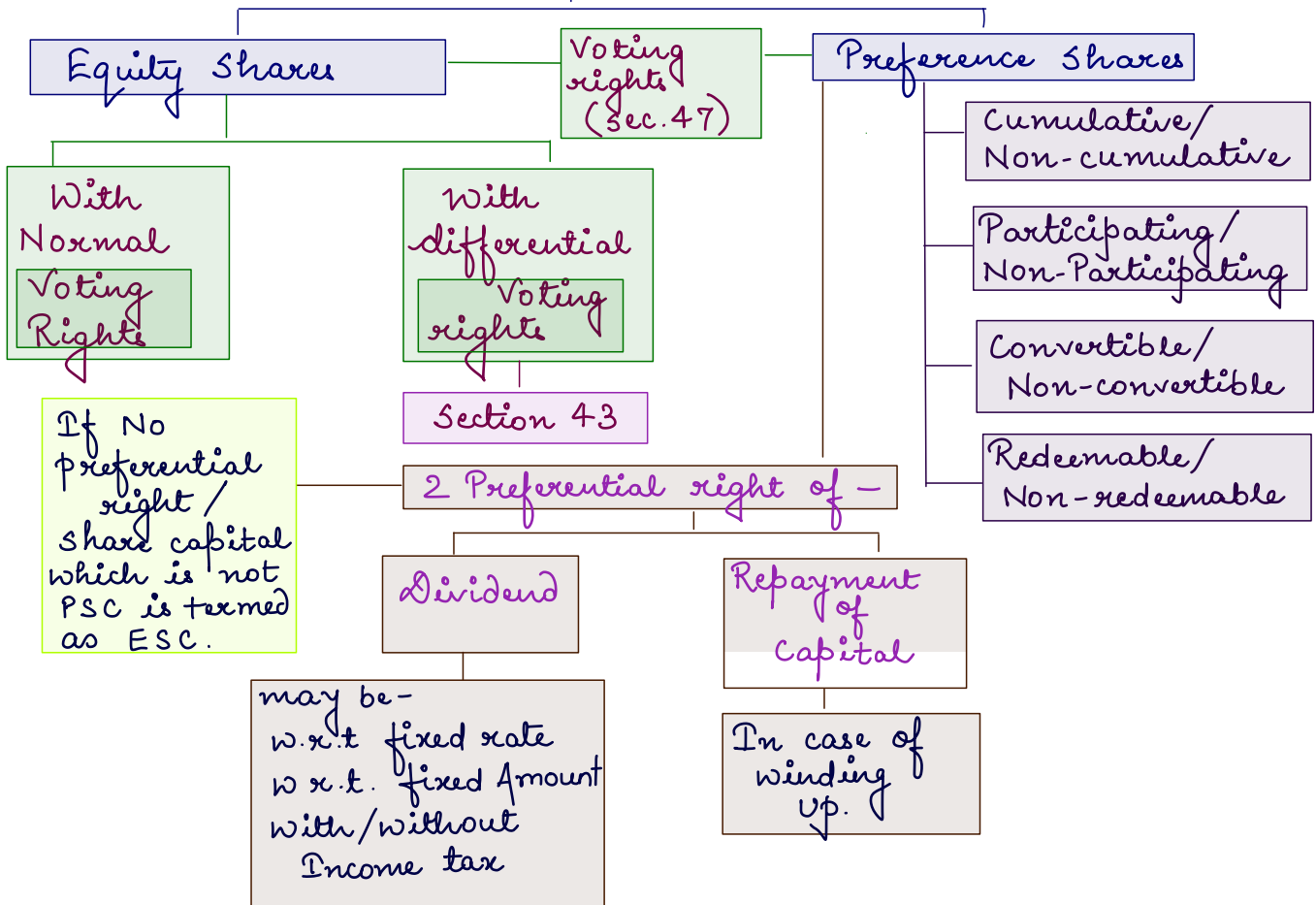

Voting Rights (Sec. 47)

Equity shareholders have right to vote on every matter

In case of Poll, in proportion to share in Paid up Capital

Preference shareholders have right to vote -

on every matter if -

Dividend not paid for 2 years or more.

on resolution affecting their right

on winding up resolution

on resolution for repayment of capital

Shares with DVR [Sec. 43] - Read with Rule 4

Not applicable to Private Co. whose MOA/AOA so provides.

Authorisation in Articles of Association

Call GM by sending Notice + Explanatory Statement

Listed Co.

Resolution by Postal ballot

Others

Ordinary Resolution at meeting.

Conditions of issue :-

Max shares with DVR = 74%

No default :- filing of FS + AR last 3 years.
Payment of dividend, repayment of deposits
redemption of Debentures/Pref. shares
Repayment of loan/statutory dues [5 years Disqualification]

Not penalised by court in last 3 years for offence of RBI Act, SEBI, SCRA, FEMA, special Act

Disclosure in Register, Explanatory Statement and Board's report.

Issue of Shares at Discount [Sec. 53]

Shares issued at discount is void

If issued

Refund all money in addition to penalty with interest @ 12% p.a.

Except Sweat Equity

or Debt converted under Debt restructuring scheme/Statutory Resolution Plan in accordance with RBI regulations

Issue of Sweat Equity Shares [Sec. 54]

issued to Directors/Employees as Reward for Value Addition

Must belong to class of shares already issued.

Call GM by sending Notice + ES

Pass SR at meeting specifying

Allot within 12 months of SR

at a discount

for consideration other than cash

No. of shares
Current Market Price
consideration
Directors/E^e

Conditions

listed company

Regulations by SEBI

Unlisted company

Rule 8 by CG

lock in period of 3 years

limit :- 15% of ESC in one FY, 25% of ESC at any time.

Start-up - limit of 50% for 10 years

Register in form SH-3

Prescribed details in Explanatory Statement & Board's Report

Non-cash consideration - treatment according to AS.

Issue of Shares at Premium [Sec. 52]

No condition, No restriction, No limit for such issue

No express Power in Articles

Private Placement

If Public offer

Transfer Premium received to Securities Premium A/c

follow SEBI guidelines also

This A/c is not a free Reserve

has Specific Uses only

If used

✓

Not used

Reduction of Capital

- Bonus Shares
- Expenses/comm/Discout on equity Shares
- Buy back

for Prescribed companies

for Others

- Buy back
- Bonus shares
- Expenses/comm/discout on Shares or Deb.
- Expenses - Preliminary
- Redemption Premium

Issue of further Shares [Sec. 62]

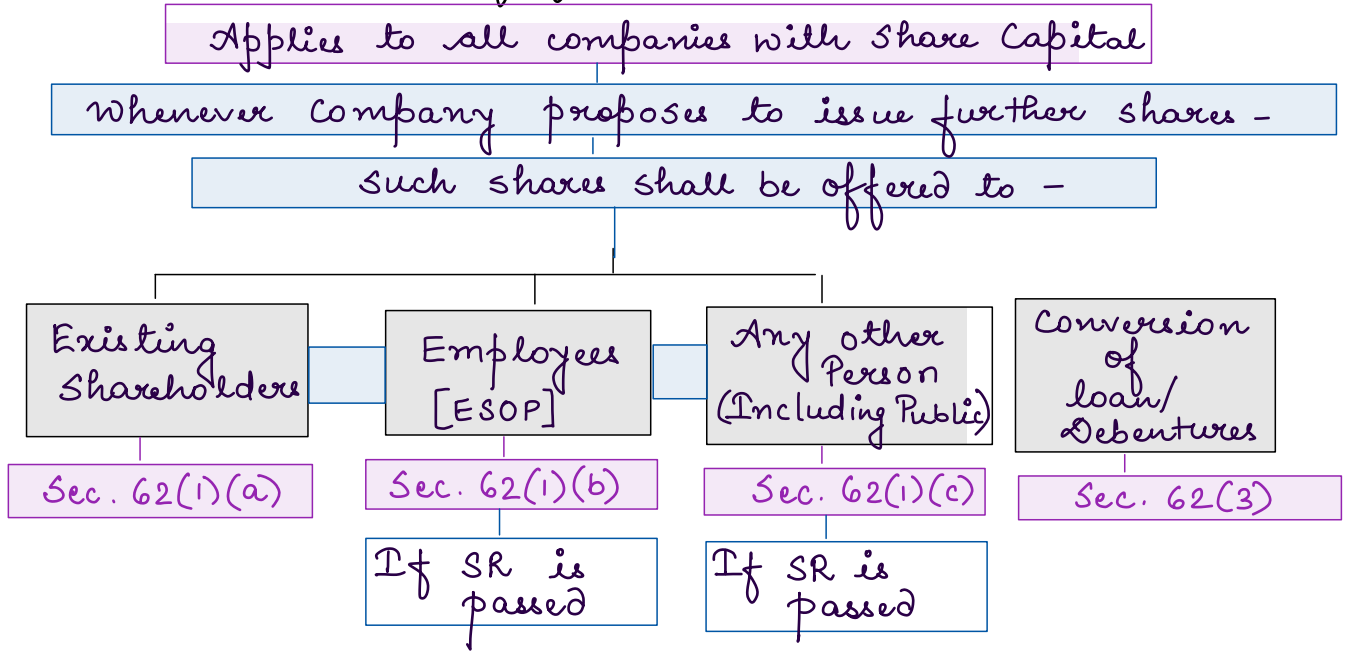

Rights issue [Section 62(1)(a)]

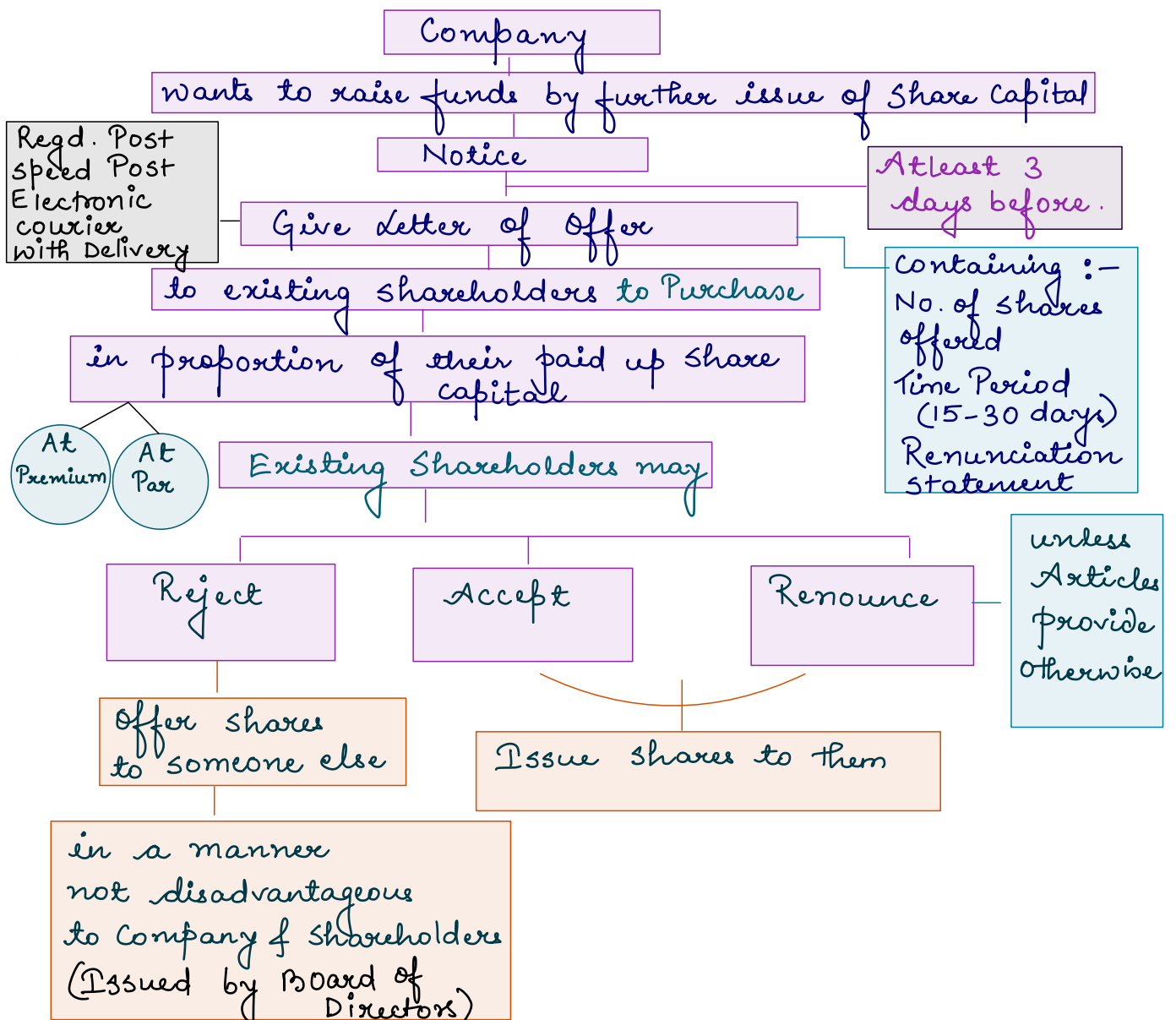

Employee Stock Option Plan (ESOP) - Sec. 62(1)(b)

Read with Rule 12

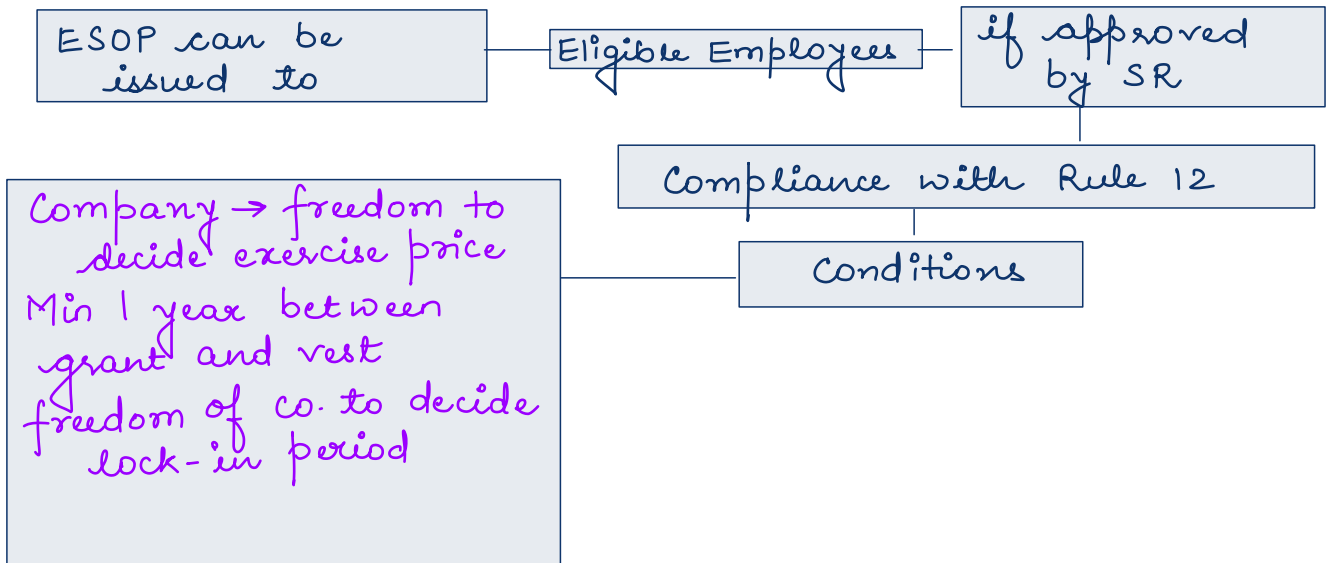

Conversion of Loan/Deb into Equity

If company

has to issue Equity shares upon conversion of debt

In case issued to Government

If in Public Interest

considering factors, Govt

thinks it may direct conversion without terms also

Co. agrees

Issue

Co. disagrees

Appeal within 60 days

to Tribunal

Tribunal shall pass order

Others

convert & issue if Terms of issue were approved by SR

No need to comply with provisions of this section

Bonus Shares (Section 63)

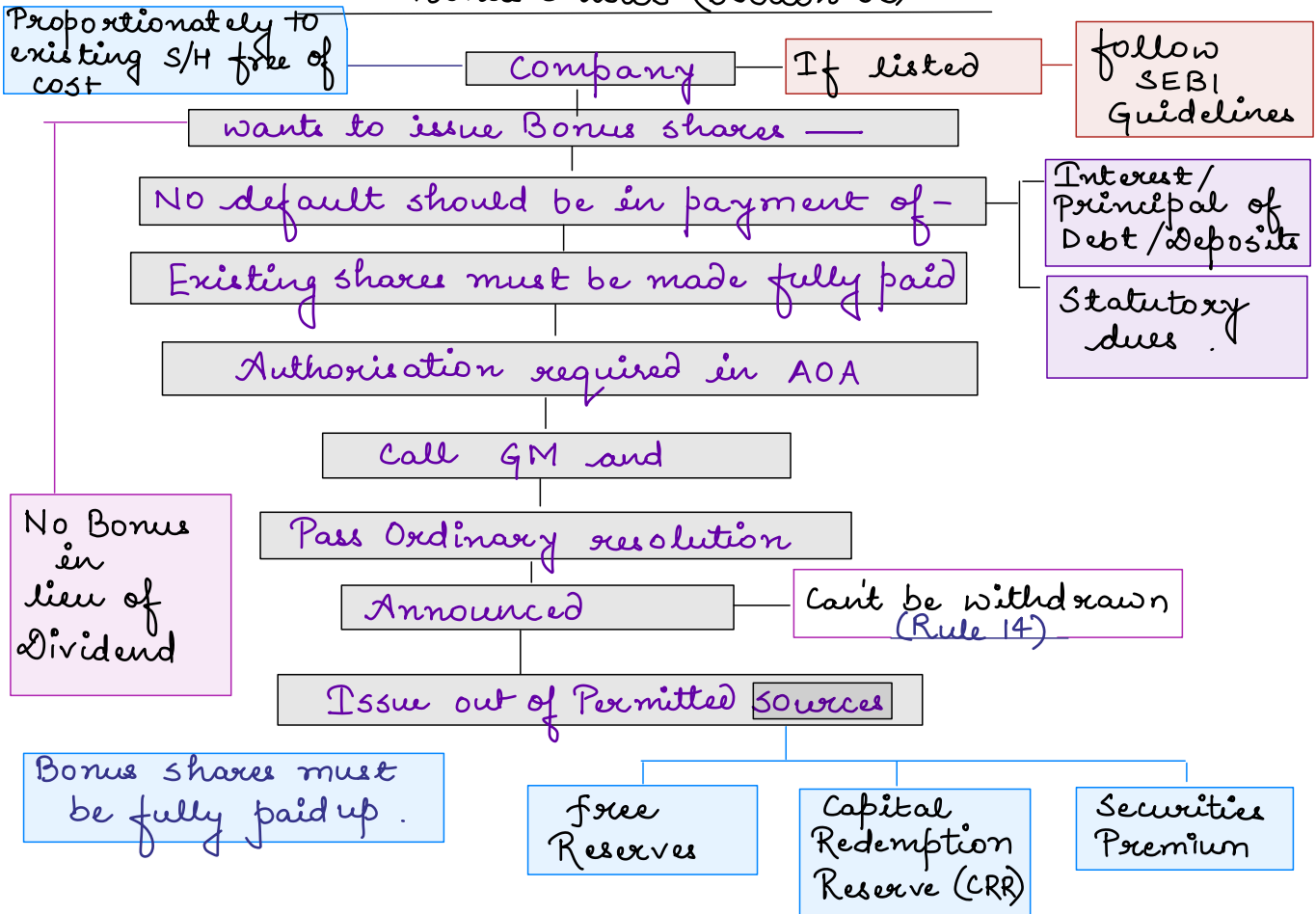

Issue of Preference Share (Sec. 55)

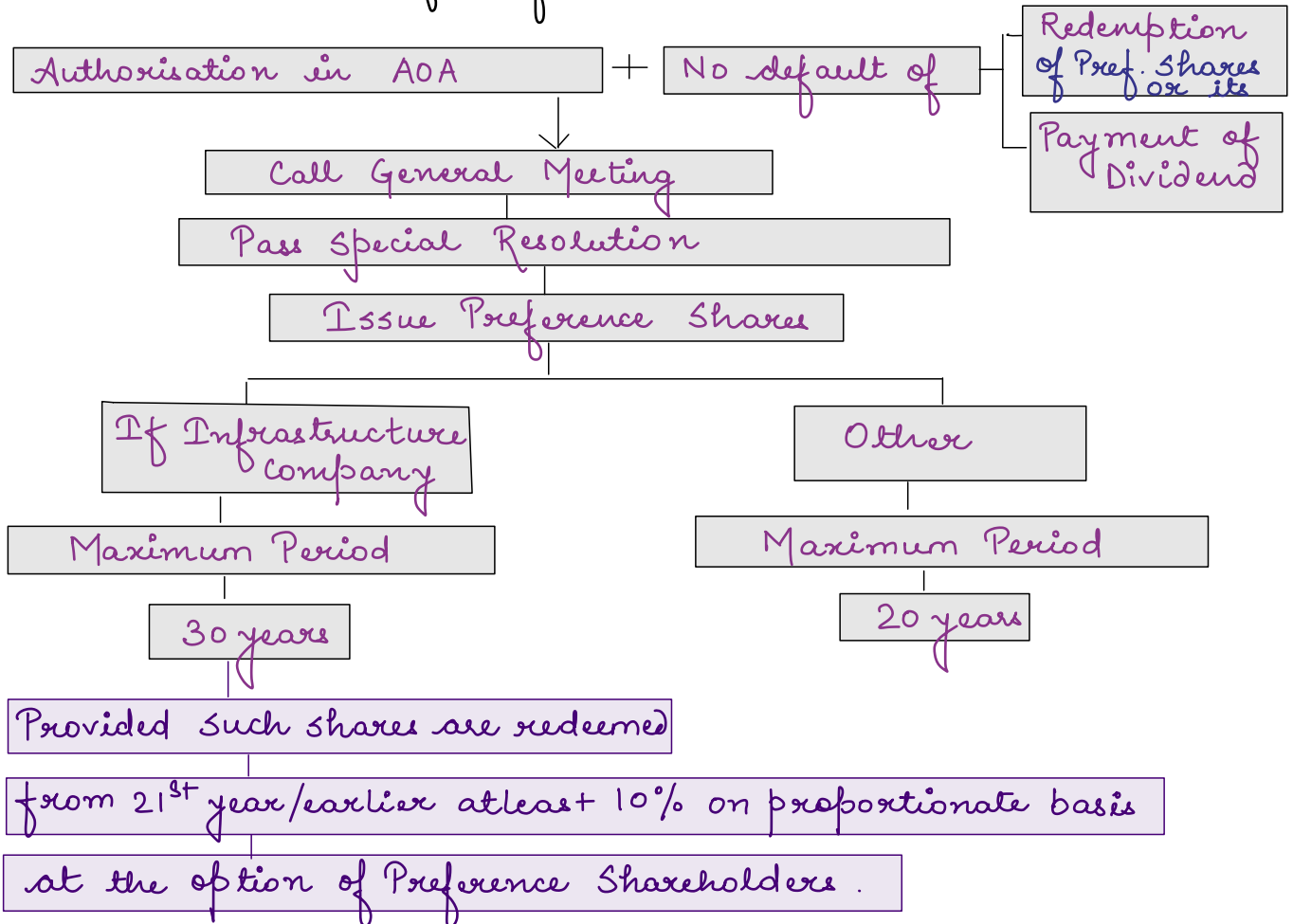

Redemption of Preference Shares

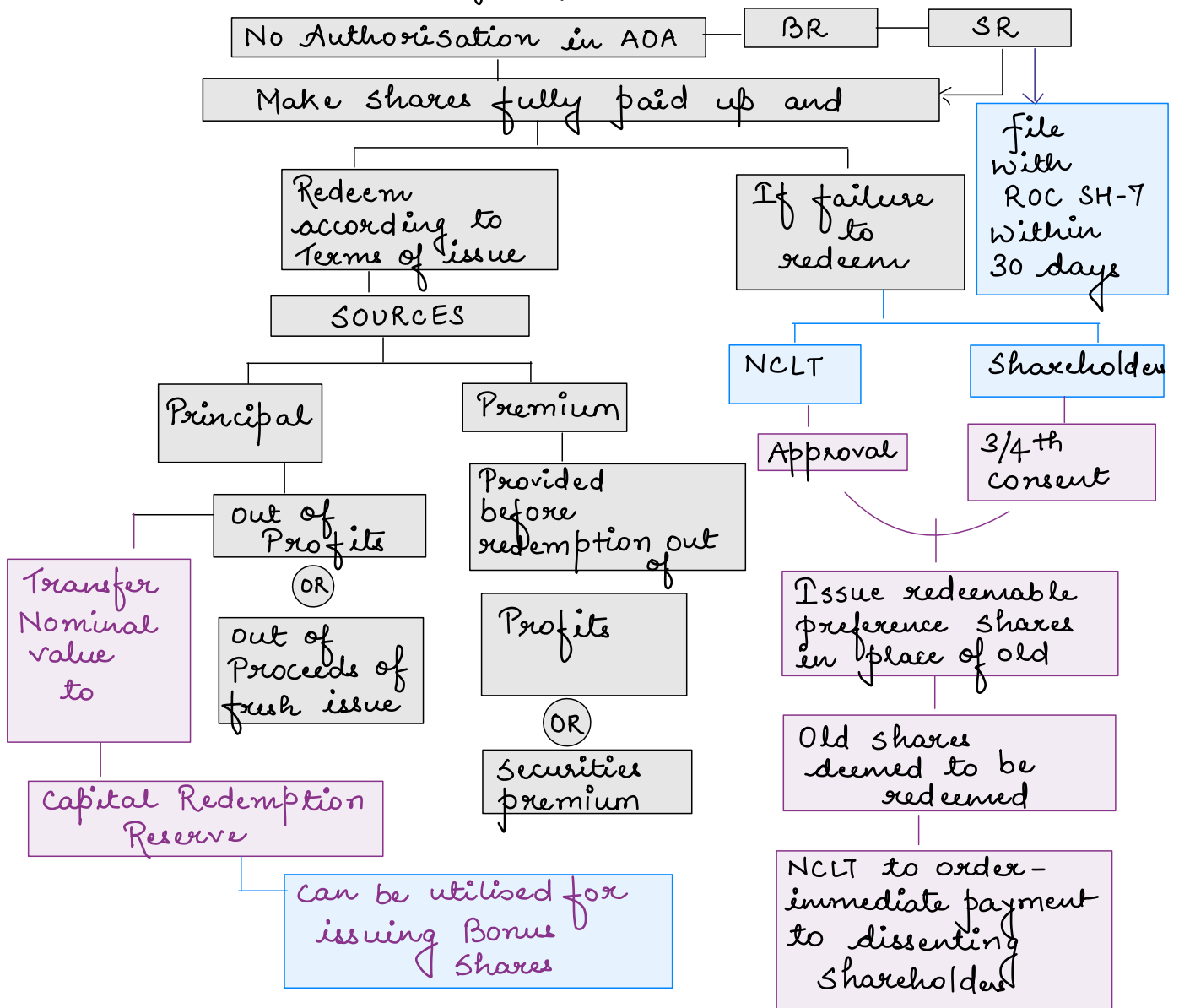

Alteration of Share Capital (Sec. 61)

Cases :-

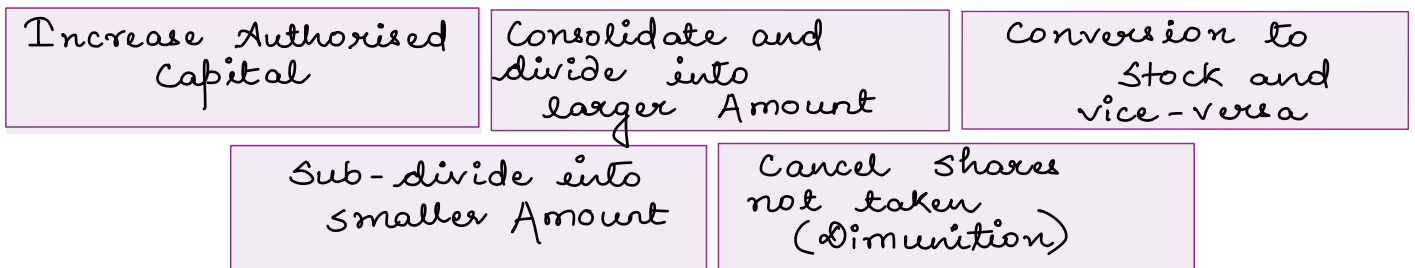

Procedure :-

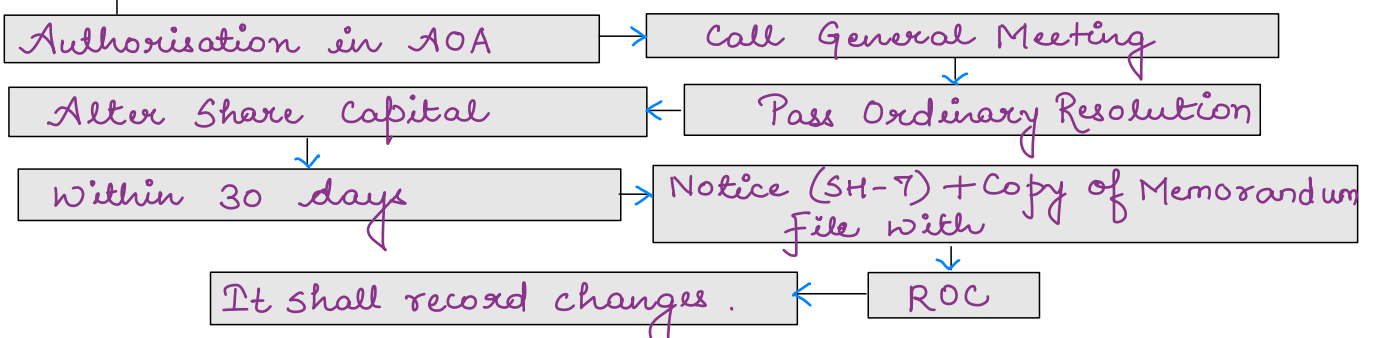

Downloaded From www.castudynotes.com
Reduction of Share Capital [Sec. 66]

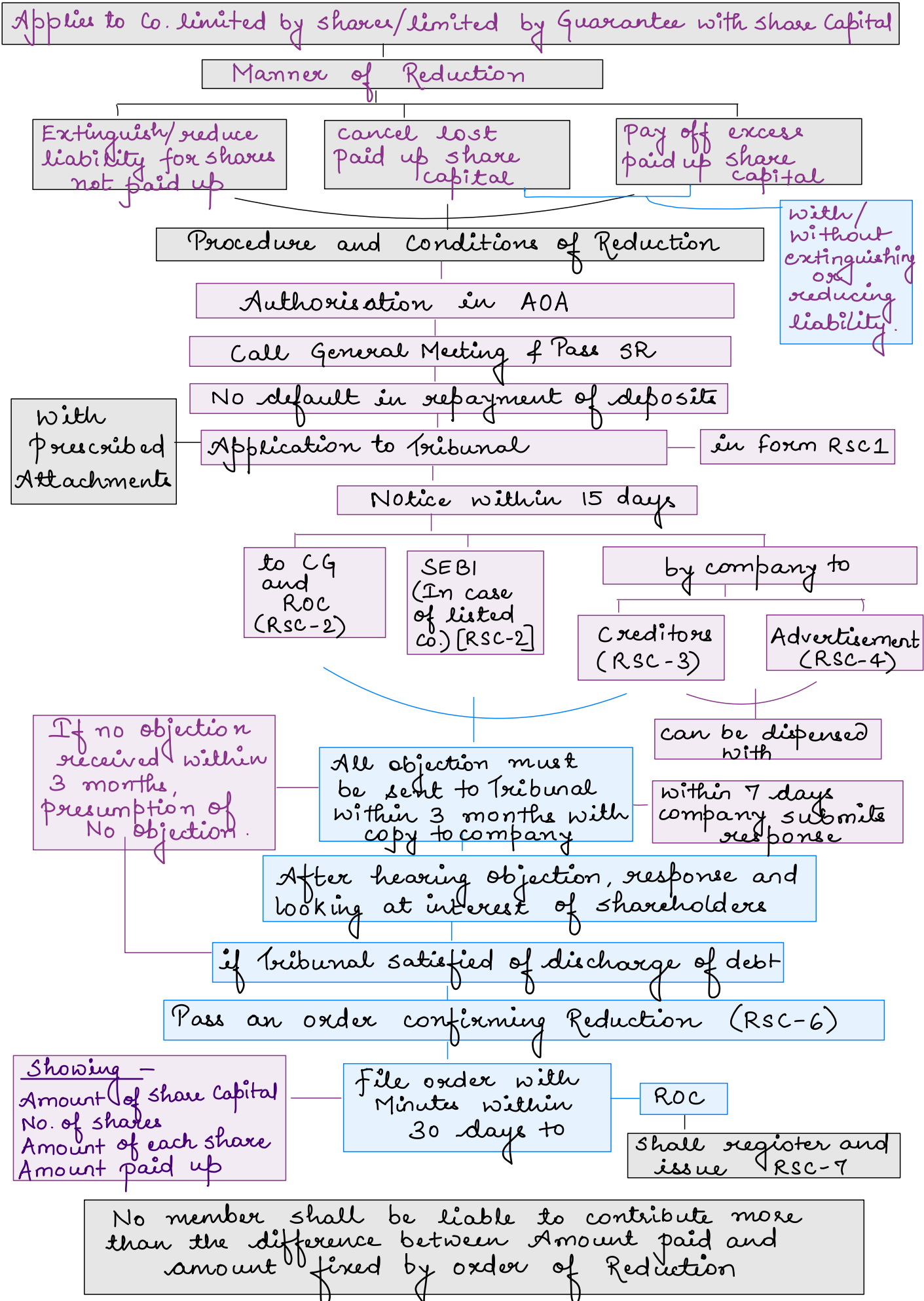

Prohibition on financial Assistance for Buy Back (Sec. 67)

Company not to give Direct/indirect financial assistance for Purchase of its own shares / of Holding co.

Exceptions

Lending by Banking co. in ordinary course of business.

In acc. with Scheme by SR for benefit of E^e for fully paid up shares.

Giving of loans not exceeding 6 months salary of E^e for fully paid up shares

N.A. to Private co. if -
→ No Body corporate invested in it.
→ Borrowings less than lower of (2xPUC or 50 cr)
→ No default in such repayment of borrowings

Prohibition of Buy-back in certain case (Sec. 70)

No Buy-back allowed

If default by company in-

Repayment of Deposits/ interest
Redemption of Debentures
" " Pref. shares
Payment of Dividend
Repayment of Term loan/ interest due to any financial Institution

If Non-compliance of

Sec. 92 (Annual Return)
Sec. 123 (Declaration of Dividend)
Sec. 127 (Payment of Dividend)
Sec. 129 (Financial Statement)

Allowed if default rectified AND 3 years lapsed

Buy - Back Provisions

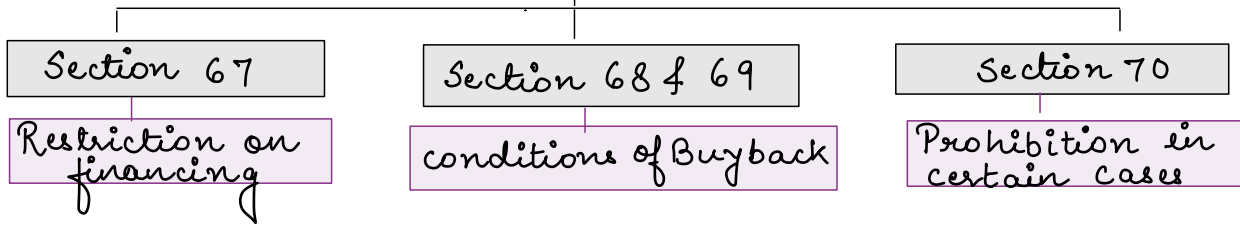

Buy back of Securities [Sec. 68]

A company may purchase its own shares / Specified securities

If Authorisation in AOA out of

SEBI compliance for listed Co.



Transfer Nominal Value to CRR (Sec. 69)

Check the limit of Buy back -

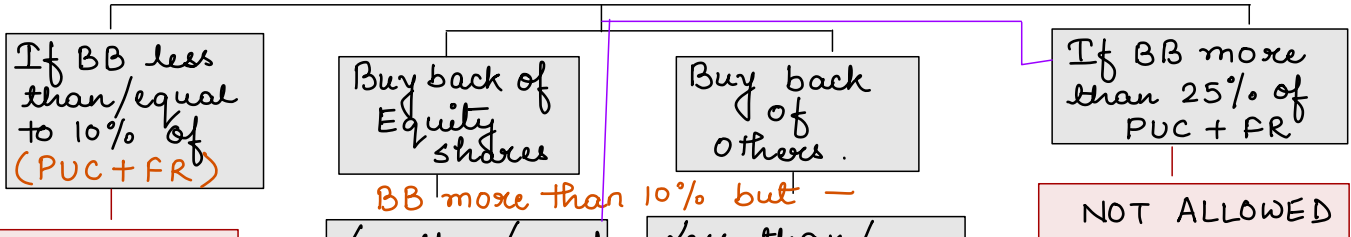

Call GM by sending Notice + Explanatory Statement

Pass Special Resolution

Partly Paid up shares

Not allowed

fully paid up shares

from Existing Holders

Open Market

Employees

through letter of offer

Agree

Disagree

Min Time 15 days
Max Time 30 days

BUY

Destroy Physical Certificate (7 days)

No BB within 1 year

No new issue within 6 Months

file Declaration of Solvency with ROC (SH-9)

Maintain Register (SH-10)

file return of BB within 30 days. (SH-11)

Other Points of BB :-

- Buyback shall be completed within 1 year of passing of resolution for buy-back (SR or BR)
- Ratio of debt owed by the company must ^{not} be more than twice the aggregate of Paid-up capital and free reserves after such buy-back. (CG may notify a higher ratio for any class)

Transfer of Securities [Sec. 56 read with Rule 11]

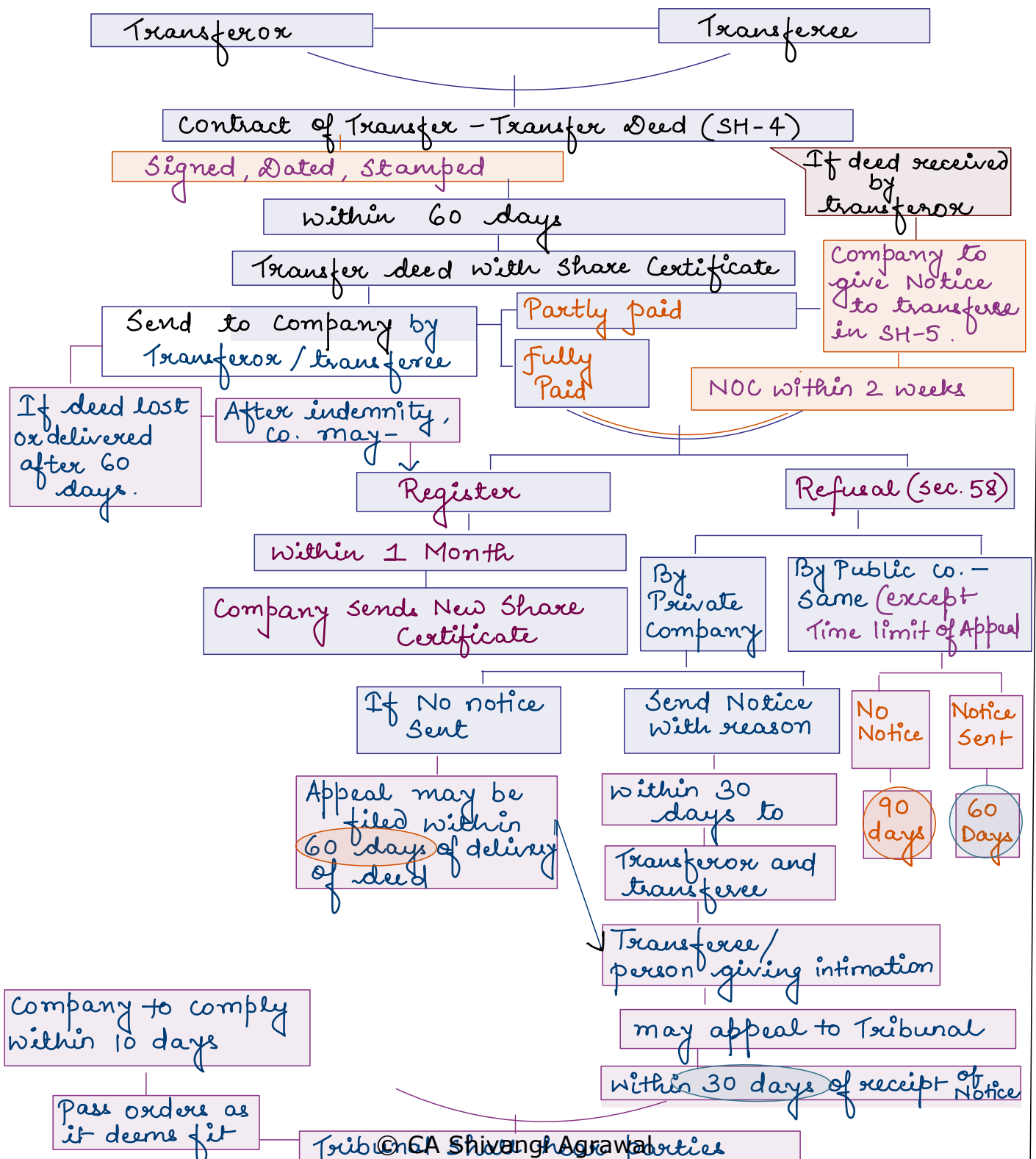

Transmission of Securities.

It is different from Voluntary transfer. In this, A person becomes entitled to shares by operation of law.

No transfer Deed, On receipt of intimation

Company registers the securities in the name of -

legal representative/
official assignee

No voting right until name registered

Forged Transfer

Transfer of shares where Transferor's sign are forged on transfer Deed.

It is void ab initio

Original owner continues to be member

If company registered transferee as member

Original member can compel company to restore name

Company cancel share certificate of transferee

If transferee transferred to innocent Purchaser
New Purchaser not entitled to securities

But right to claim damages from co. and co. → Right to recover damages from depositor of forged deed.

Rectification of Register [Sec. 59]

Person aggrieved / Member / Company

may appeal for rectification

if entry without cause
omission without cause
Default / delay in entering
or removing name
without cause

with Tribunal

Tribunal after hearing parties
may dismiss appeal
order rectification
damages

Company, Depository, DP,
SEBI, Holder

may apply for rectification

if transfer in contravention
of Co's Act, SCRA, SEBI, other law

to Tribunal

Tribunal to direct company
to rectify.

Debentures [Sec. 71]

No Debenture shall carry any voting right.

May issue convertible (full/part) Debentures

may issue Secured Debentures

complying with Rule 18 conditions

after passing SR in GM

Tenure of Redemption -
Max - 10 years
Infrastructure - Max 30 years

at prescribed percentage

Create DRR out of profits available for Dividend

Secured by charge on Assets - sufficient

Invest prescribed Amount in Specified Assets.

Appoint Debenture Trustee

- compulsory if - prospectus is issued
- Public offer is made
- offer to members exceeding 500

Before issue of Prospectus / letter of offer

Appoint Debenture trustee if Mandatory

To perform duties and incur liability as prescribed

Company shall pay interest and redeem debentures acc. to terms

If failure to do so -

Debenture Holder OR

Debenture Trustee

may make application to Tribunal

Tribunal after hearing may order forthwith payment

Creation of DRR

DRR not required in case of - listed co. → AIFI
Banking
Financial Inst.
Other listed co.

Unlisted co. → NBFC & Housing finance
Private Placement

Other Unlisted co. → 10% of Deb.

Creation of DRI

On or before 30th April

Invest 15% of deposits maturing on 31st Max

in specified securities

by listed Public issue (Other than AIFI, Bank, PFI)

Unlisted (Other than AIFI, Bank, PFI, NBFC, Housing finance)

Debenture Trustee

Before appointment,

Obtain written consent and such statement to

appear in letter of offer / Prospectus.

Eligibility

Be disqualified if -

- ▷ beneficially holds shares.
- ▷ is promoter/Director/KMP/ officer/e^o of C/H/S/A.
- ▷ entitled to money apart from remuneration.
- ▷ Indebted to C/H/S/A or subsidiary of Holding
- ▷ given guarantee of debt
- ▷ has pecuniary relation [3 yrs] (lower of -
2% of Gross T/O or Total income
50 lakh
Prescribed Higher Amount)
- ▷ is relative of promoter/E^o /Director /KMP

Duties

to protect interest and redress grievances of Deb. Holders.

Convene Meeting
On written request
by Debentureholders
with 1/10th value
OR

On happening of
event affecting
interest of
debentureholders.

can be removed before term
if 3/4th value holders give
consent.

Liability

If Debenture Trustee →
Guilty of breach
of Trust OR
fails to exercise
due care

↓
liable for
damages.

[can be exempted
from some liability
if 3/4th value
holders give
consent]

Acceptance of Deposits by Companies

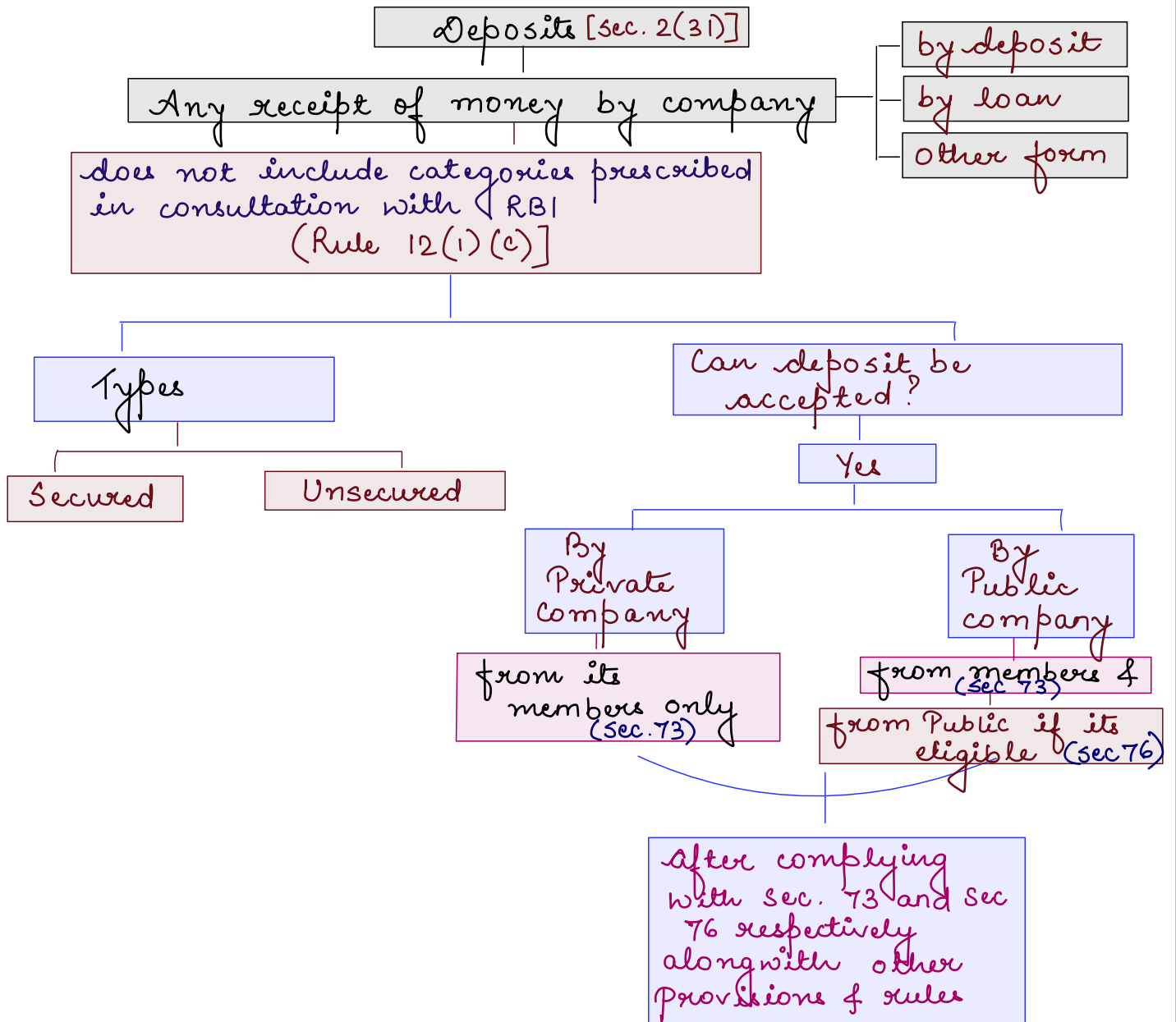

Amounts not considered as Deposits [Rule 2(1)(c)]

★	Received from Government	CG/SG/Source guaranteed by them/local Authority/ Statutory Authority
★	Received from foreign source	foreign Govt, foreign banks, Multilateral financial Institution foreign citizen etc.
★	loan/facility	from Banking co./SBI/ co-operative banks
★	loan	from Public financial Institutions (PFI)

★	Issue of instruments	Commercial Paper/ Other Instrument in accordance with RBI
★	from Company	Amount received from any other company.
★	Amount towards Subscription of Securities (including Application money)	Money Pending Allotment treated as deposit if - Money → No Allotment till 60 days ↓ Not refunded in next 15 days
★	Received from Director/ relative of Director of Private Company	Such person must provide a declaration in writing that money is not borrowed funds Co. disclose in Board's report.
★	Issue of Secured/ convertible Bonds / Debentures	Security - sufficient, either first charge / Pari Passu with 1 st charge. Convertible - within 10 years
★	Listed Debentures	if Non-convertible, non-secured but listed on RSE.
★	Received from Employee	not exceeding Annual salary & no interest (Under Contract)
★	Received in trust	Non-interest bearing.
★	Trade Advances	for Goods/Services - Appropriate within 365 days. for immovable property under agreement & adjusted accordingly. Security deposit for performance of contract. long term projects for supply of capital goods. in the form of warranty for future services under agreement. as allowed by sectoral regulator for subscription towards publication.
★	Received from Promoters	If loan brought because of stipulation by bank. Exemption till repayment of bank loan.

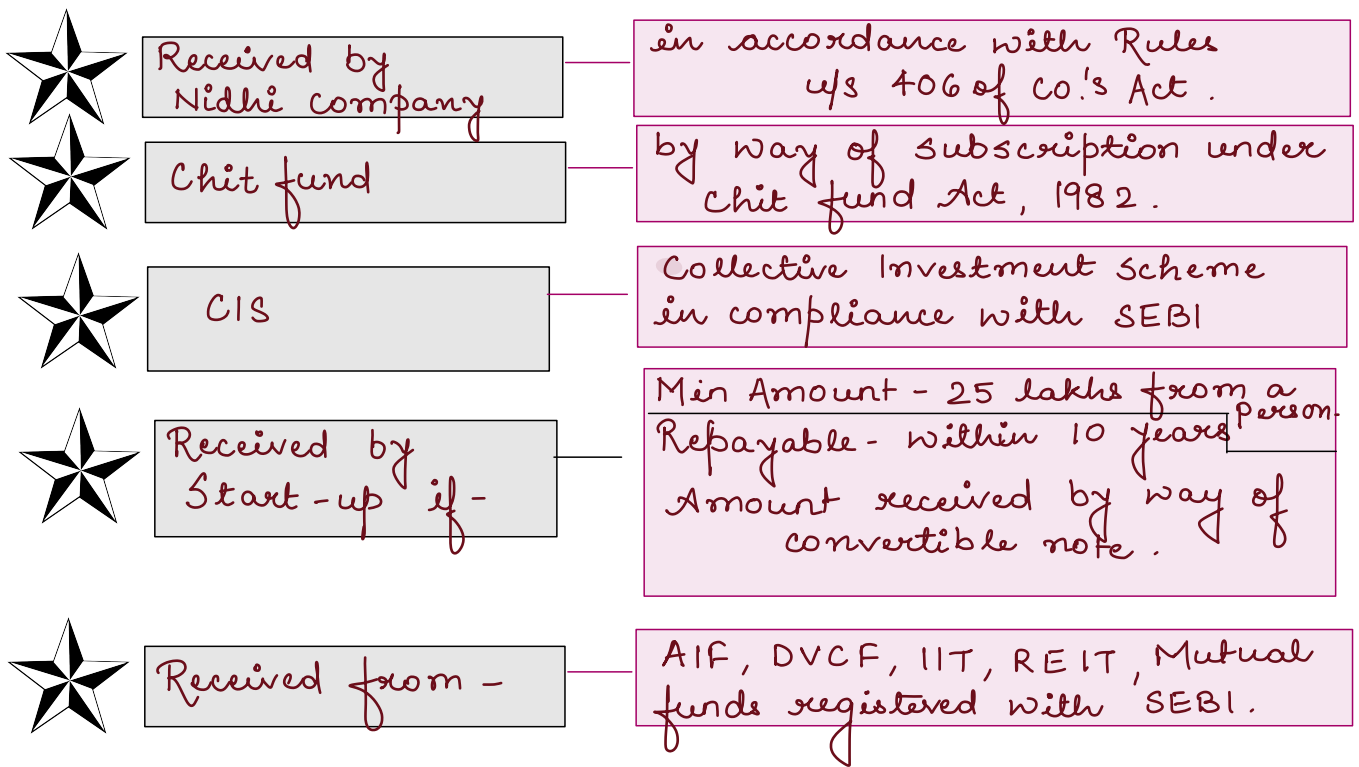

Depositor [Rule 2(i)(d)]

Member of Private / Public company who has deposited money with company

Non-member who has deposited money with eligible Public Company.

Following types of companies are exempted from Deposit provisions -

(i.e. Such companies can accept any receipt of money from anyone without compliance to this chapter)

Exempted companies - (Sec. 73(1))

- Banking company
- Non-Banking financial company
- Housing finance company
- Other company specified by CG in consultation with RBI.

Acceptance of Deposits from its Members [Section 73]

Company (Public or Private)

may accept deposits from members

by complying with such rules as prescribed by CG

Procedure / Steps as under :-

Call GM and Pass OR

Prepare circular (DPT-1 containing financial position, credit rating, Depositors (Name, Amount), Others).

Prepare Certificate of No default in repayment of Deposit / interest

file circular with ROC 30 days prior to issue

Execution of Deposit trust deed to appoint Trustee

Issue circular to members inviting deposits from them.

Creation of charge for the security provided.

Accept deposits and issue Depository receipts within 21 days of receipt of money

Transfer to DRR (20% of deposits maturing following year) before 30th April

File Return of Deposits (DPT-3) before 30th June with ROC

Repay Deposits & interest in time

Sec 73(2)(e)

Sec. 73(2)(b)

Sec 73(2)(a)

Sec. 73(2)(c)

N.A. to Private company if

- It accepts deposits upto 100% of PUC + FR + premium
- Start-up for 10 years from incorporation
- Pvt co. which is not Associate or subsidiary AND Borrowings less than lower of 2X PUC or 50 crores AND No subsisting default of repayment of Deposits.

If failure

Depositor may make Application (NCLT II)

It may order company to pay & pass other orders.

to Tribunal

Acceptance of Deposits from Public (Section 76)

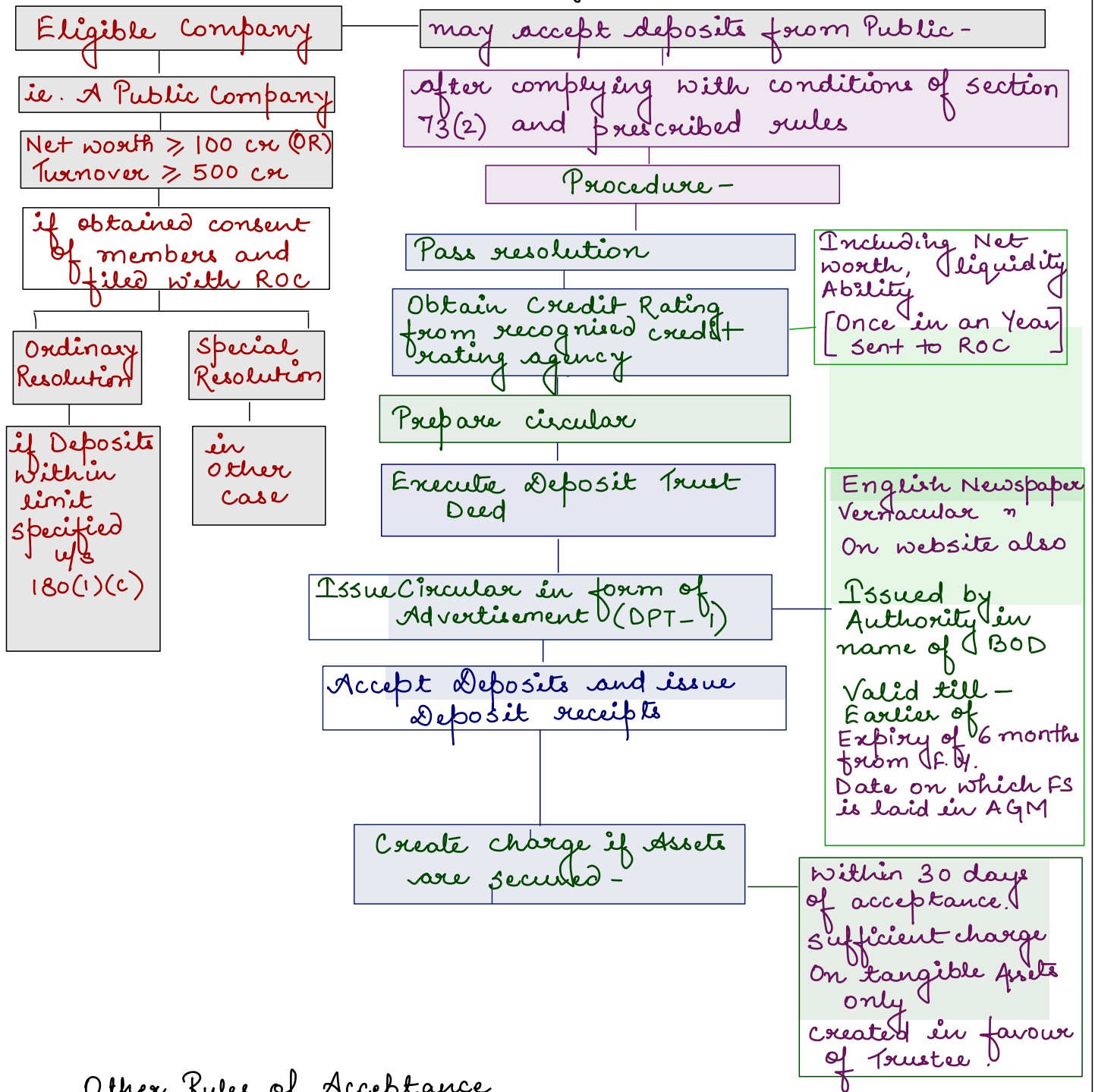

Other Rules of Acceptance

Maintain deposit register containing name, address, PAN of depositor, Date, Amount, interest, duration, charge, Nominee Preserved for 8 years, kept at registered office.

Disclosure in financial Statement :-

Amount received from Directors by way of notes [Public Company]

Amount received from Directors & relatives of Directors by way of notes [Private Company]

Tenure of Deposite

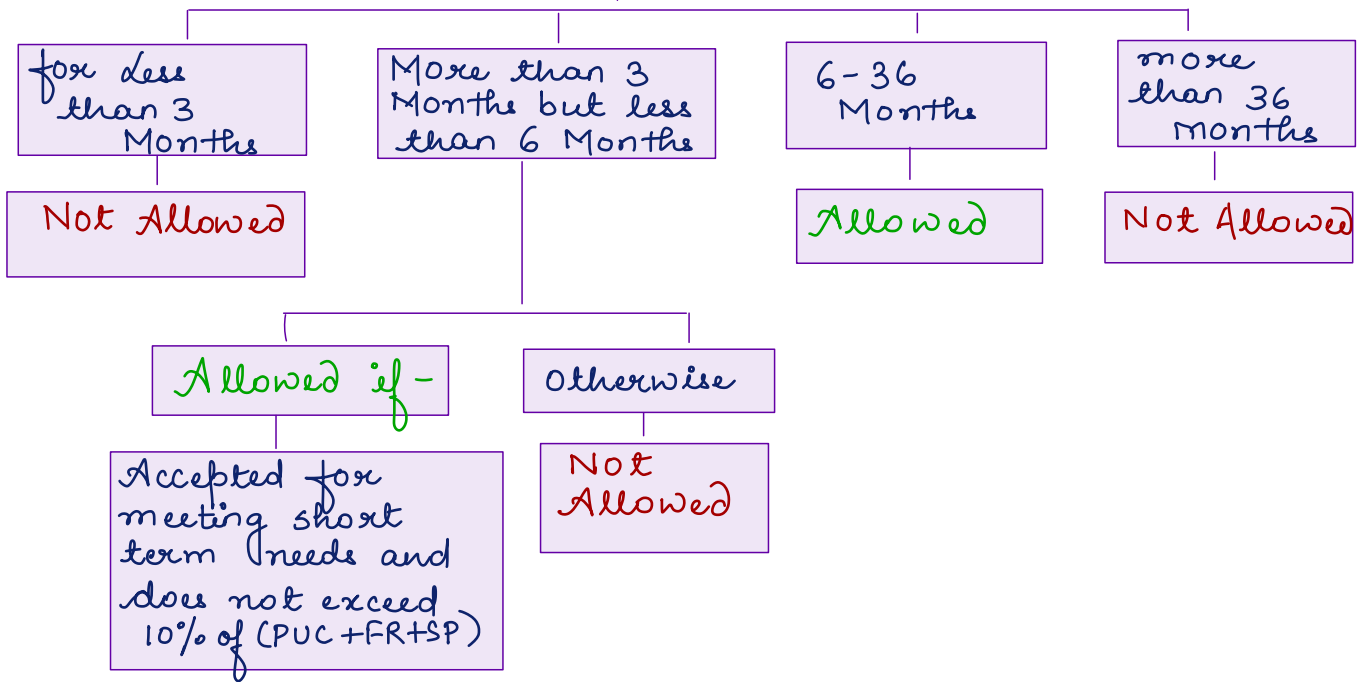

Limit on Deposite

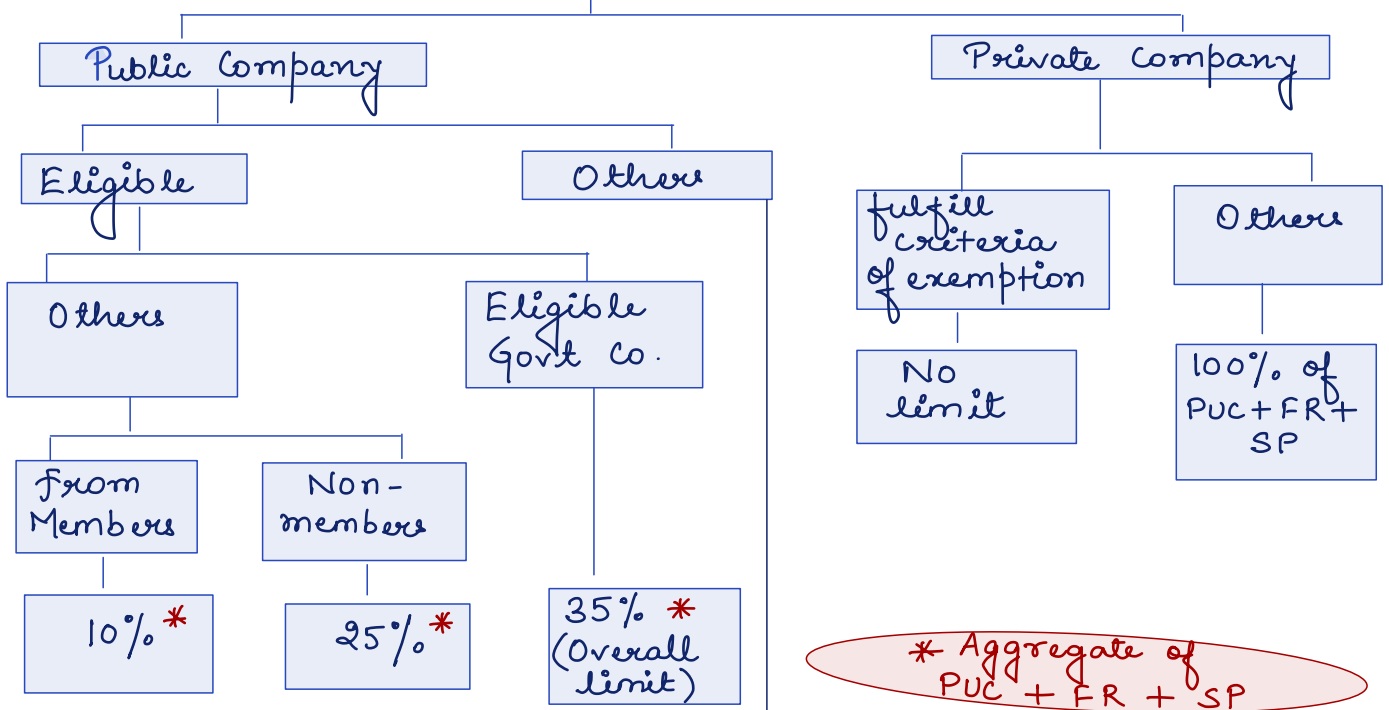

All other type of company - 35% (PUC + FR + SP) from members
 IFSC public co. - 100% (PUC + FR + SP) from members

Deposits may be accepted in joint names not exceeding 3.

Rate of interest not more than rate specified by RBI for NBFCs

Appointment of Trustee for Depositors

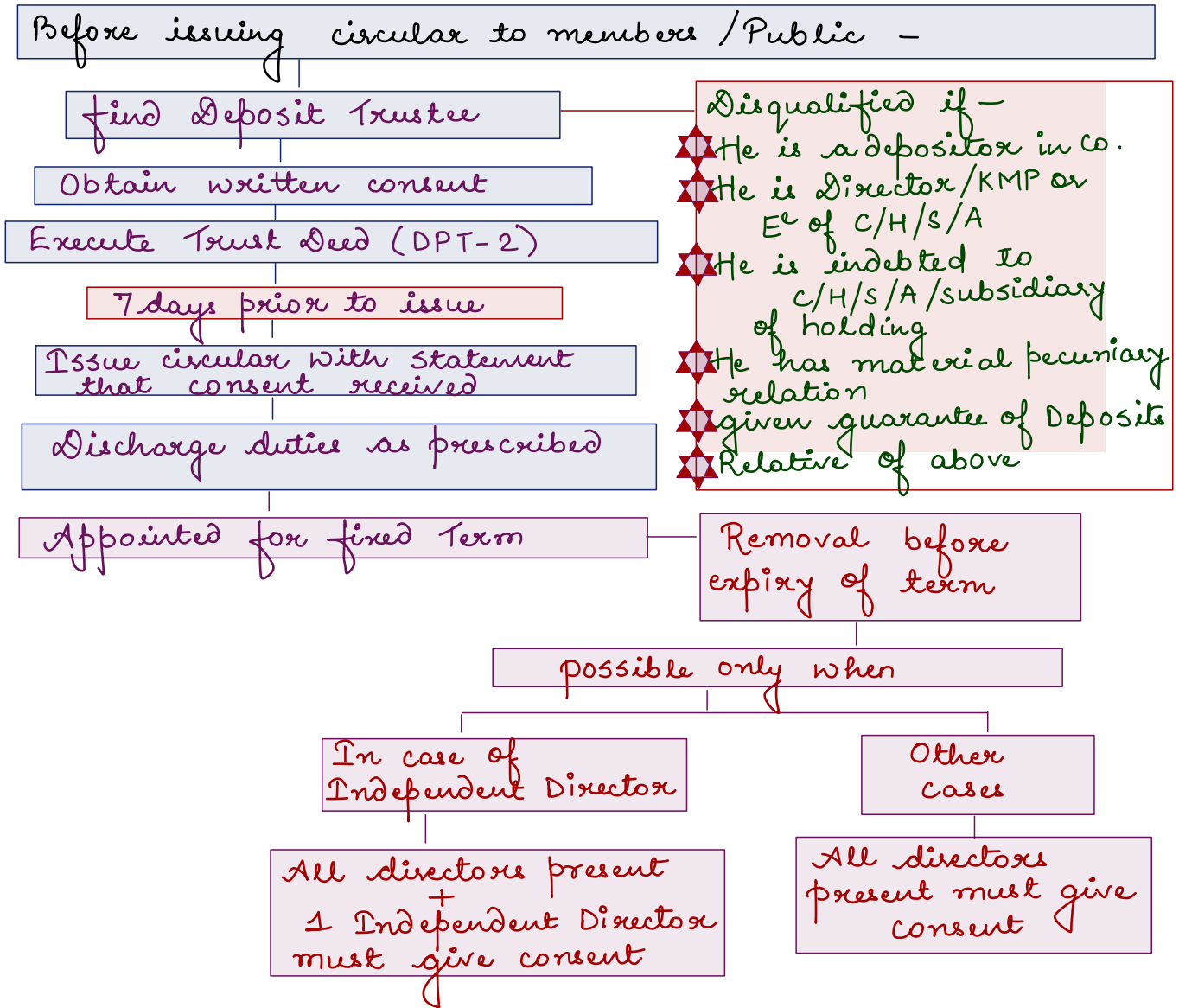

Repayment of Deposits accepted before Commencement of Act [Sec. 74]

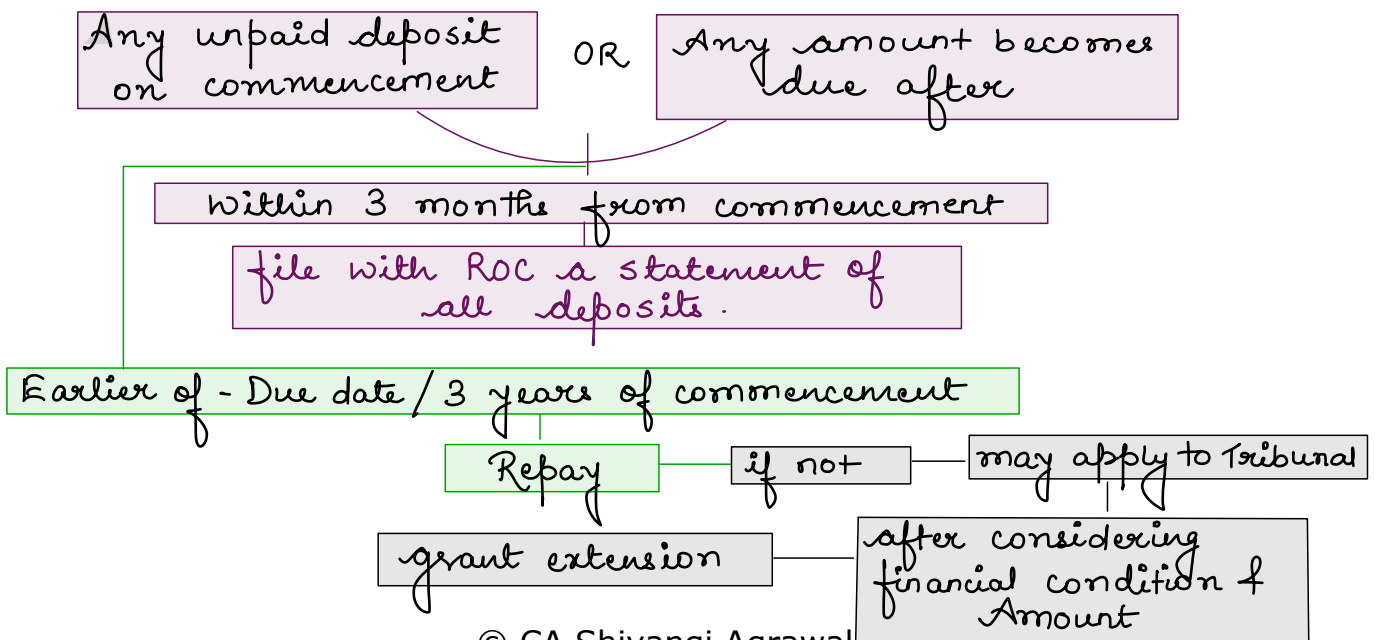

Contravention of Section 73 or 76 or rules

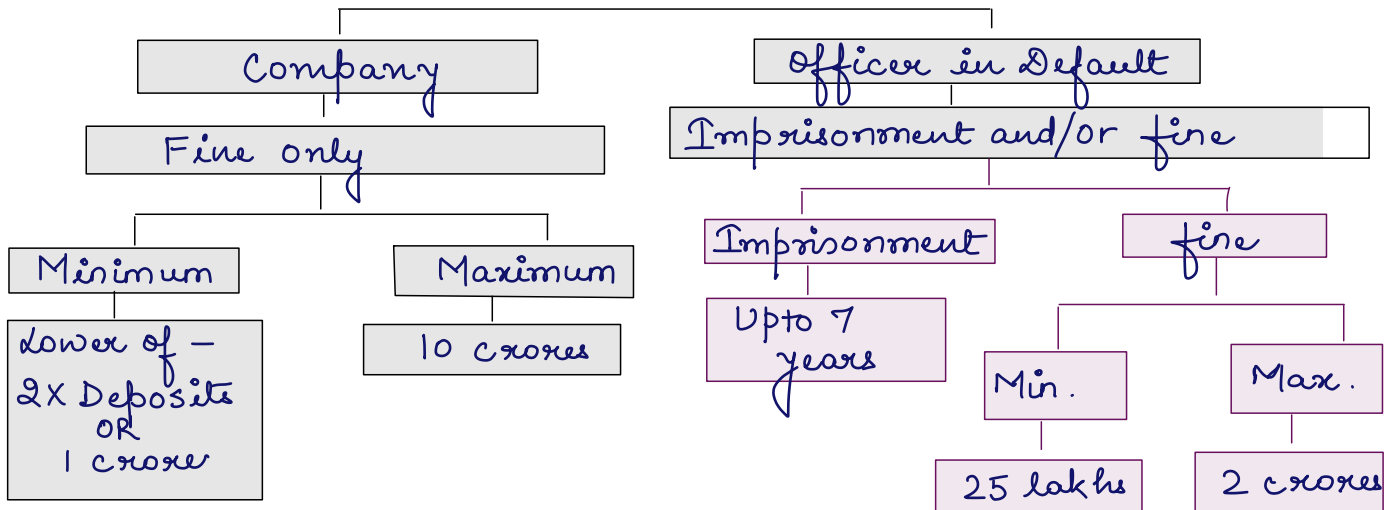

liable u/s 447 if intention to deceive proved.

Registration of Charges

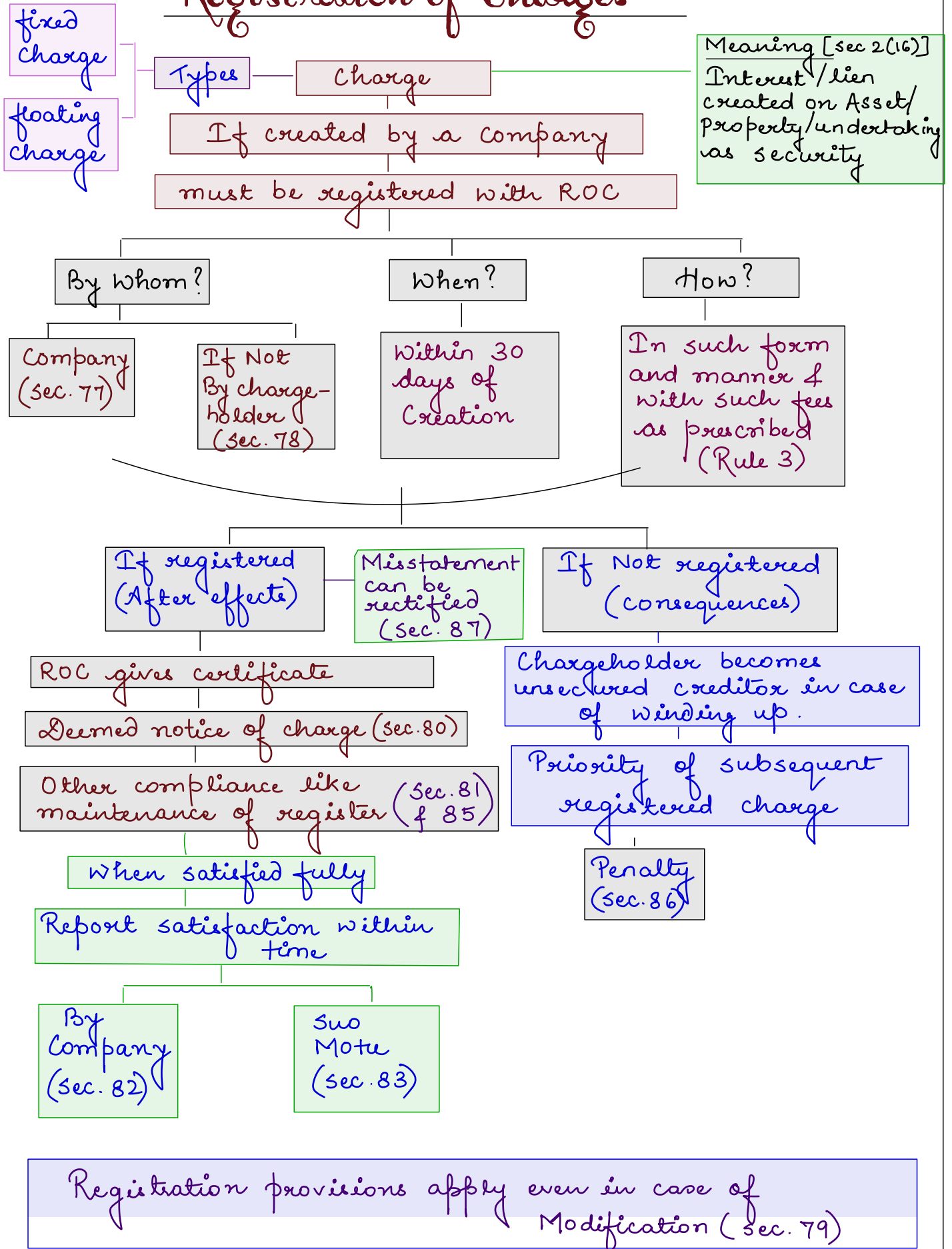

Date of Notice of charge (Sec. 80)

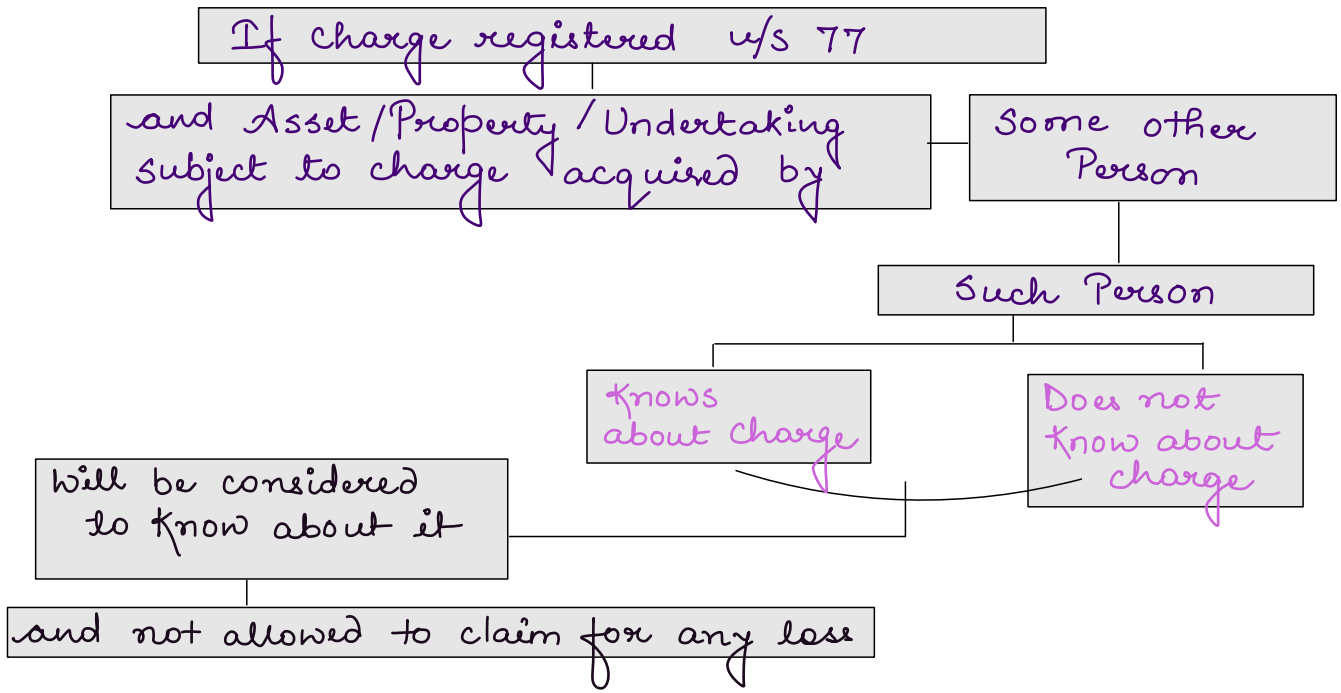

Duty of Company to register charge (Sec. 77)

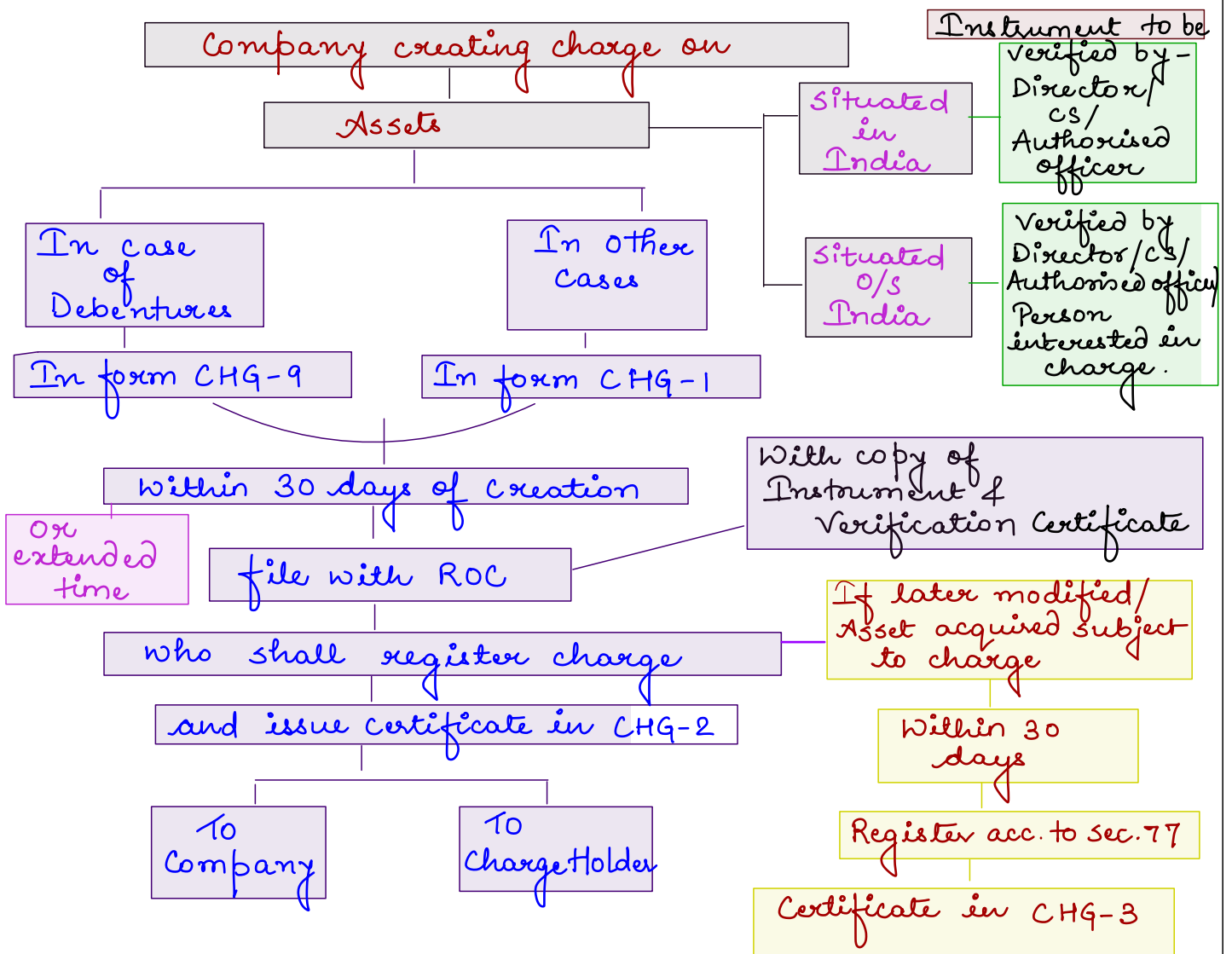

Time limit for Registration of charges

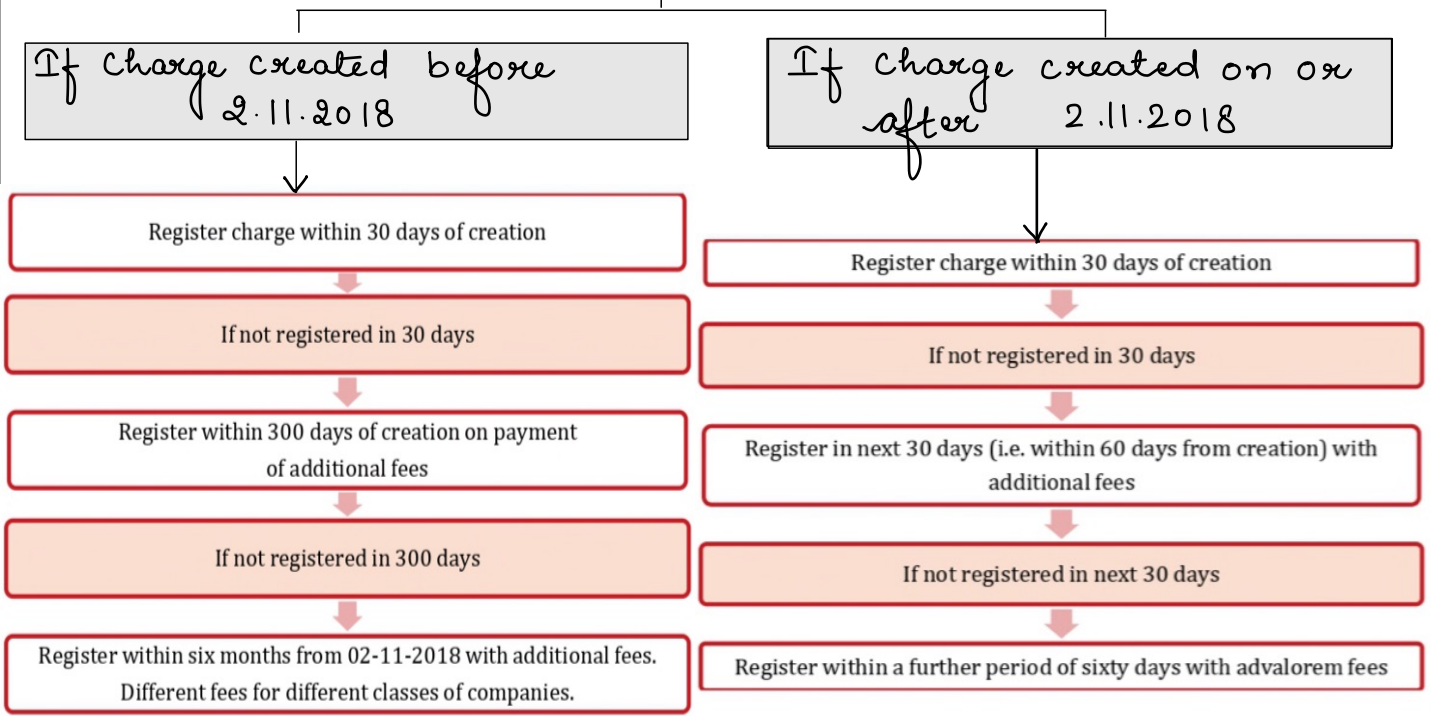

Registration of charge beyond this period is not allowed

No further extension for registration can be granted.

Registration of Charge by Charge Holder (Sec.78)

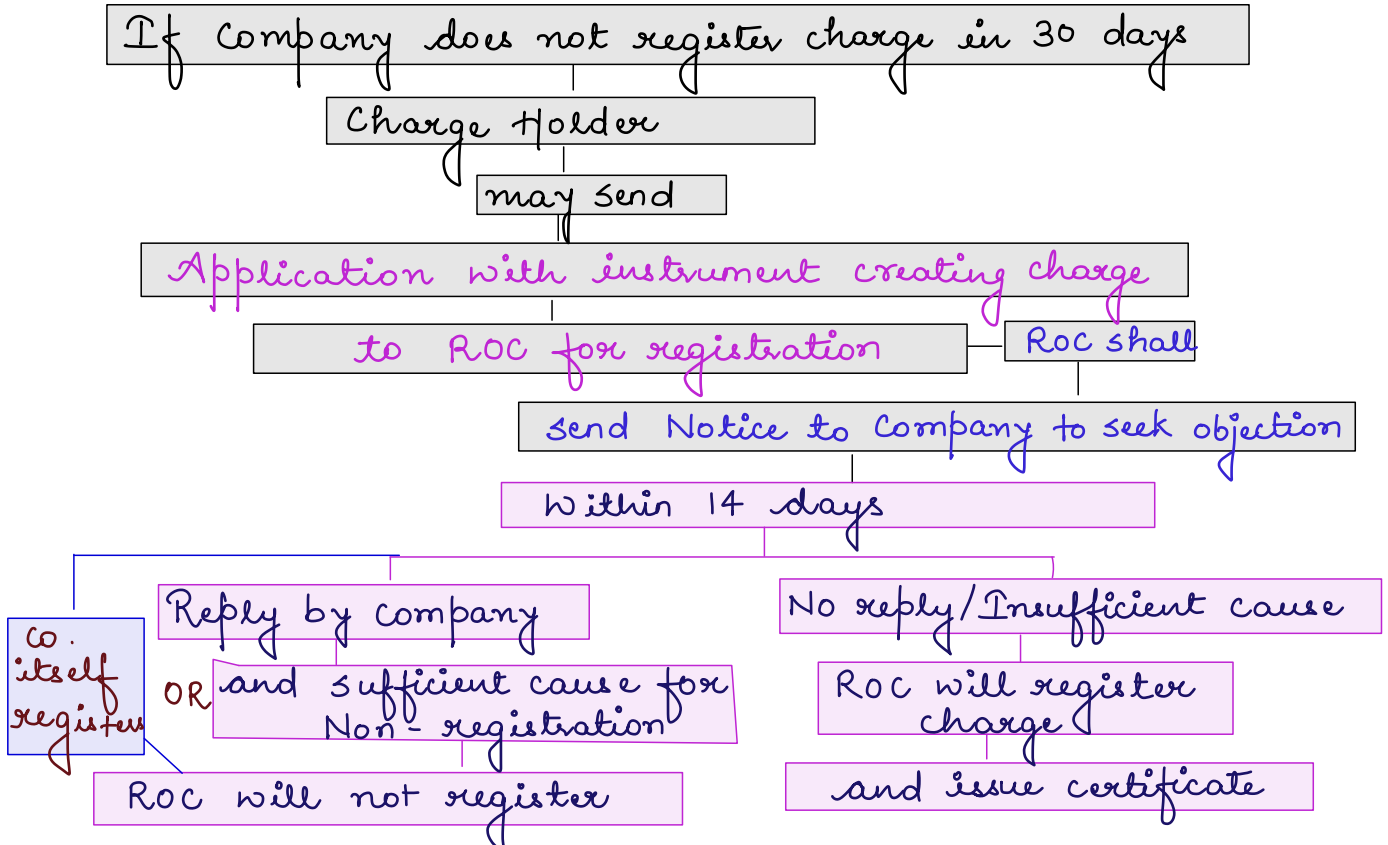

Consequences of Non-Registration.

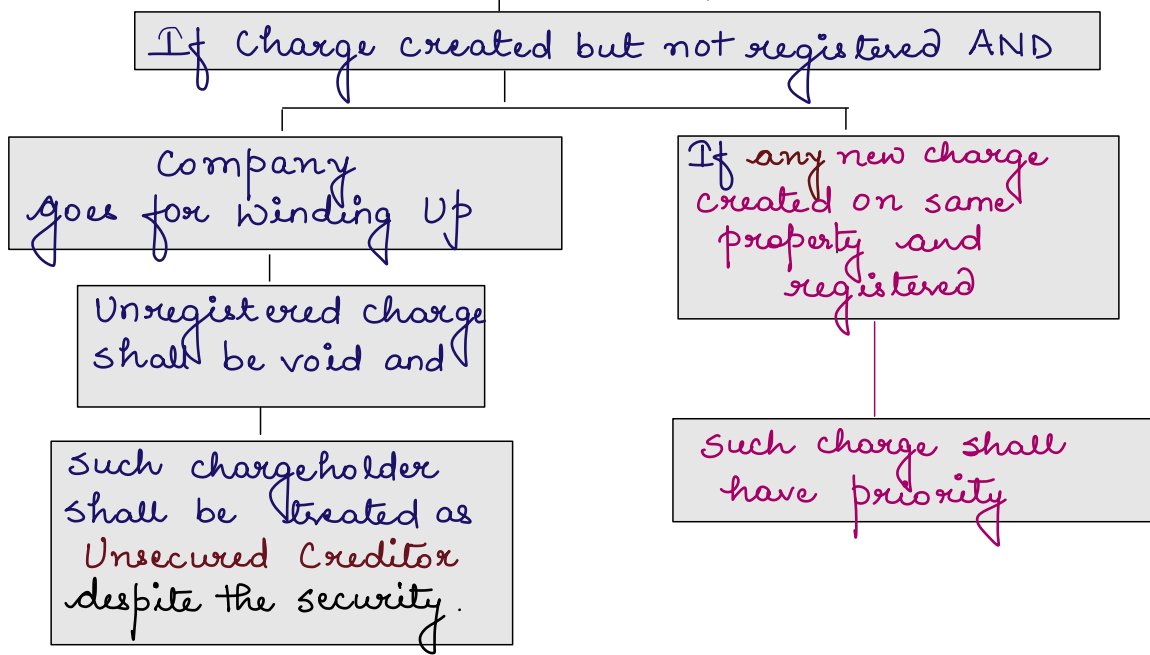

Register of Charge (Sec. 85)

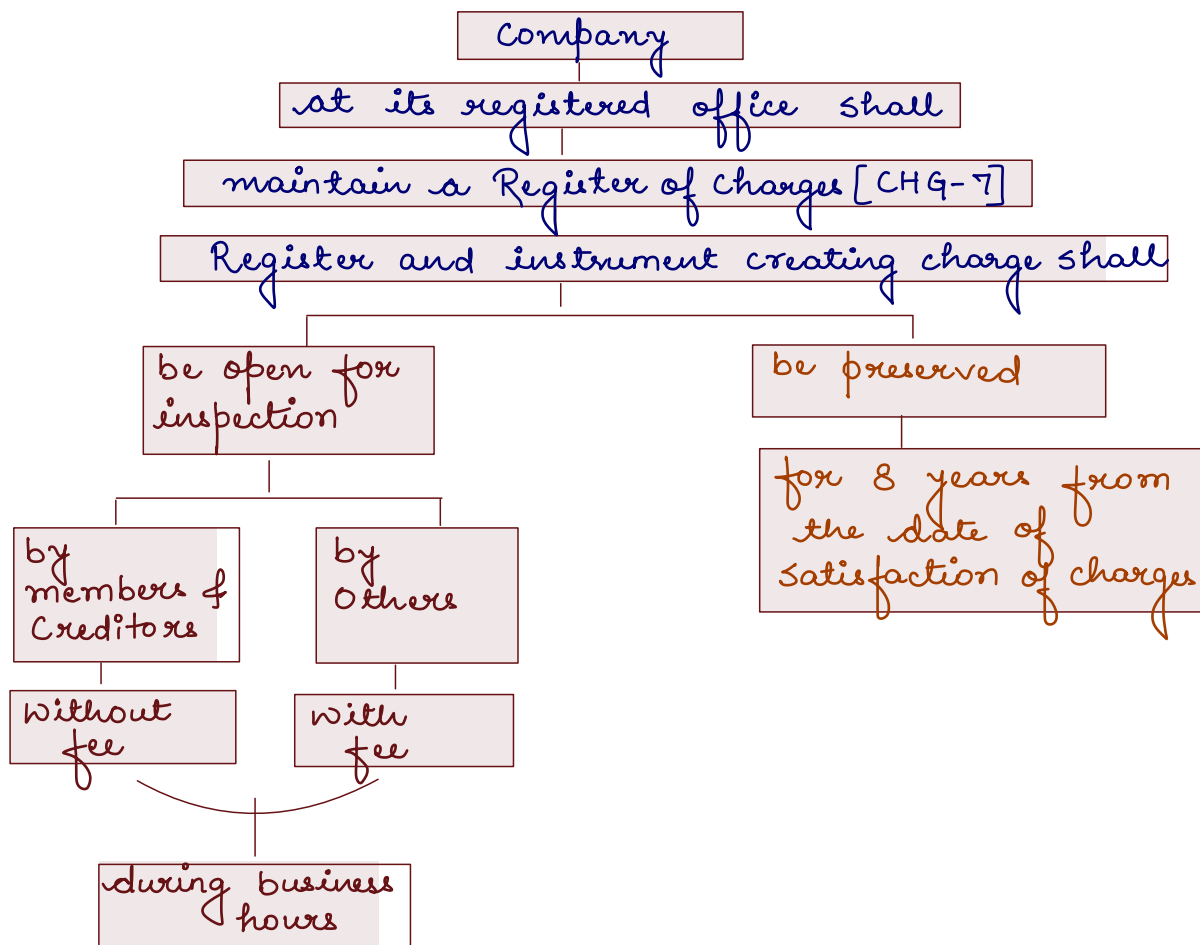

A register shall also be maintained by Registrar and open for inspection.

Satisfaction of charge (Sec.82)

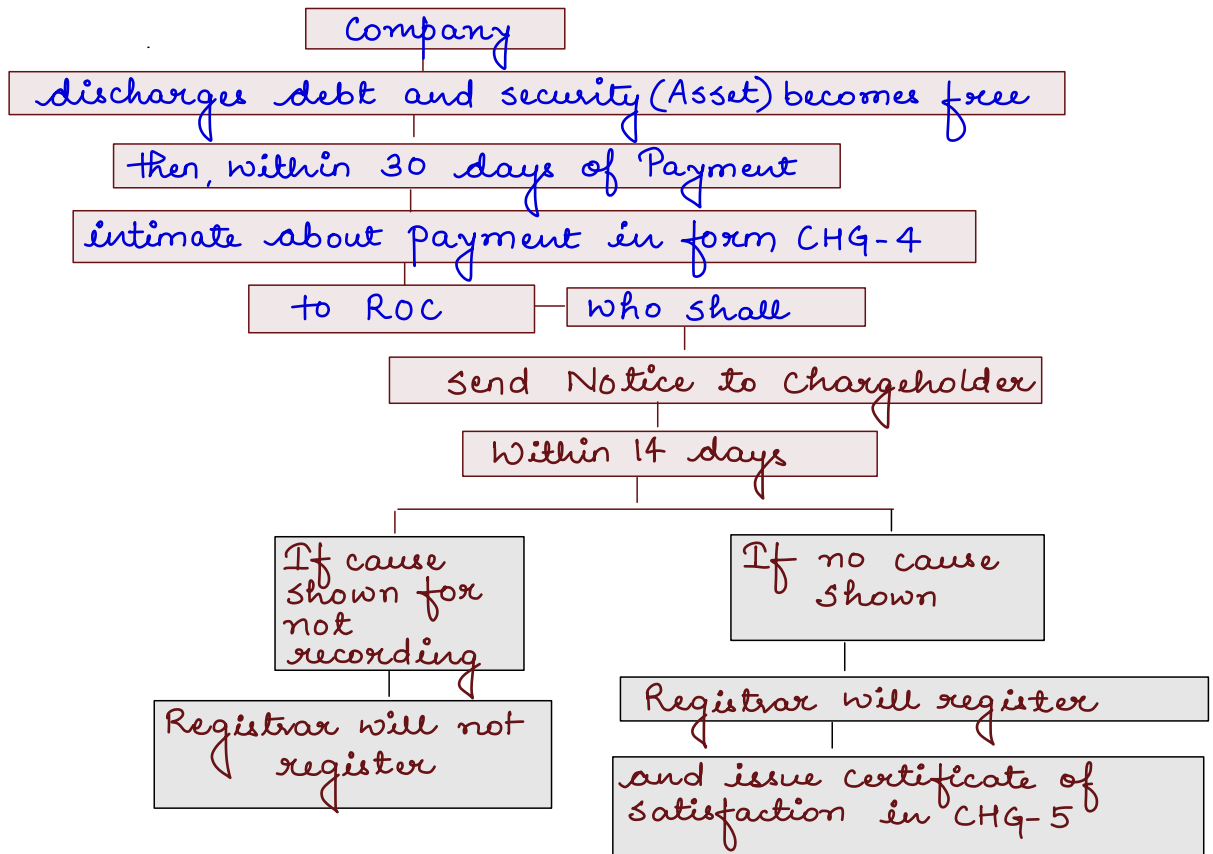

Satisfaction of charge without intimation by company Section 83

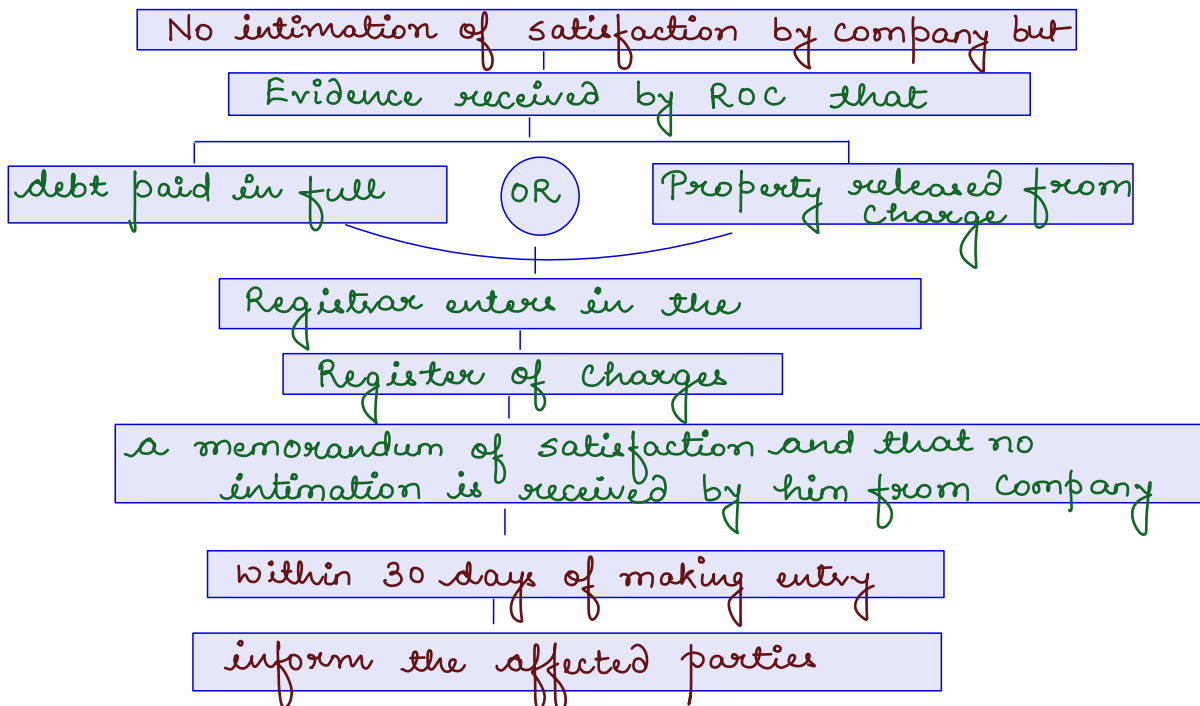

Downloaded From www.castudynotes.com
Rectification in Register of Charges (Sec. 87)

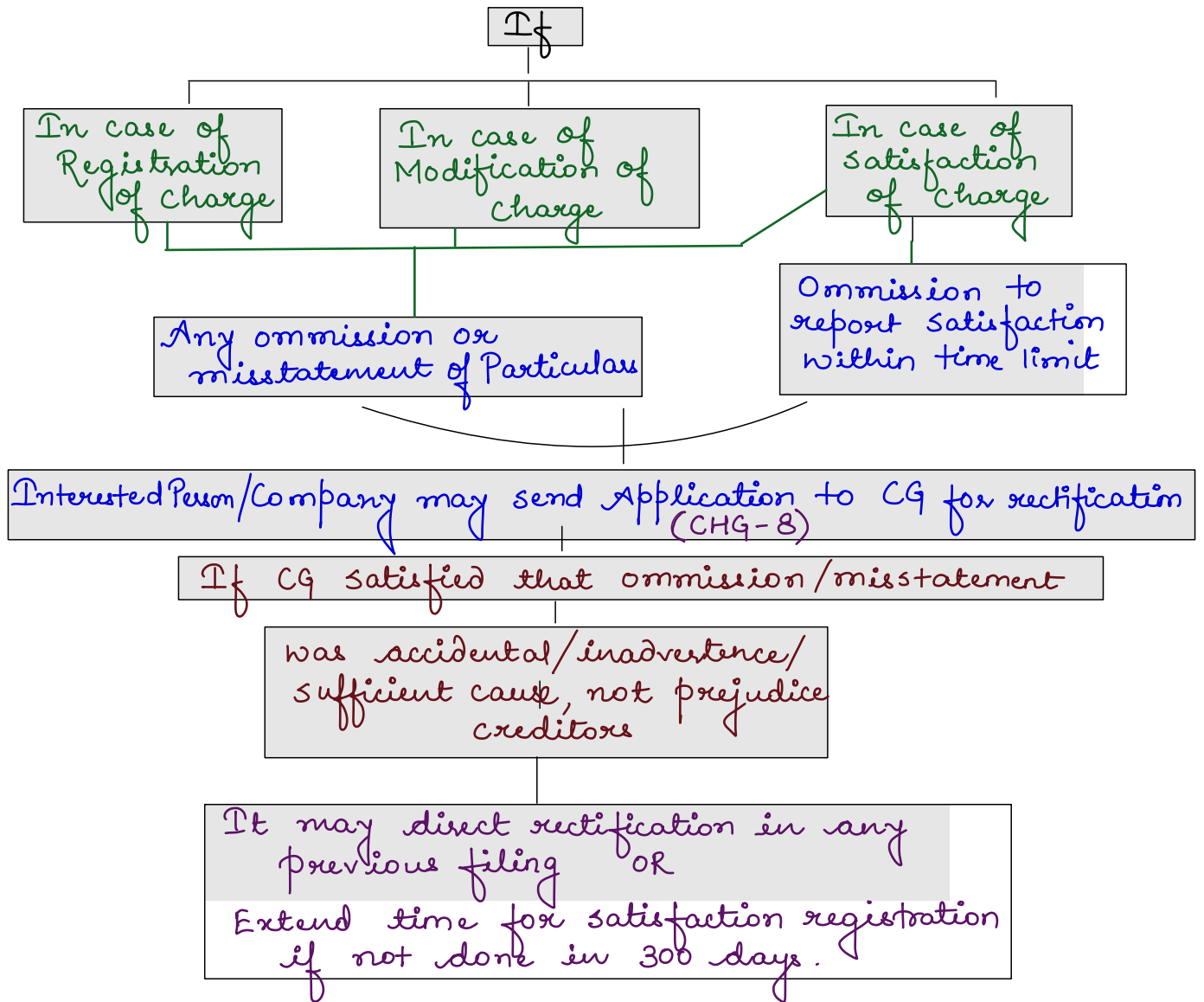

Types of Charges

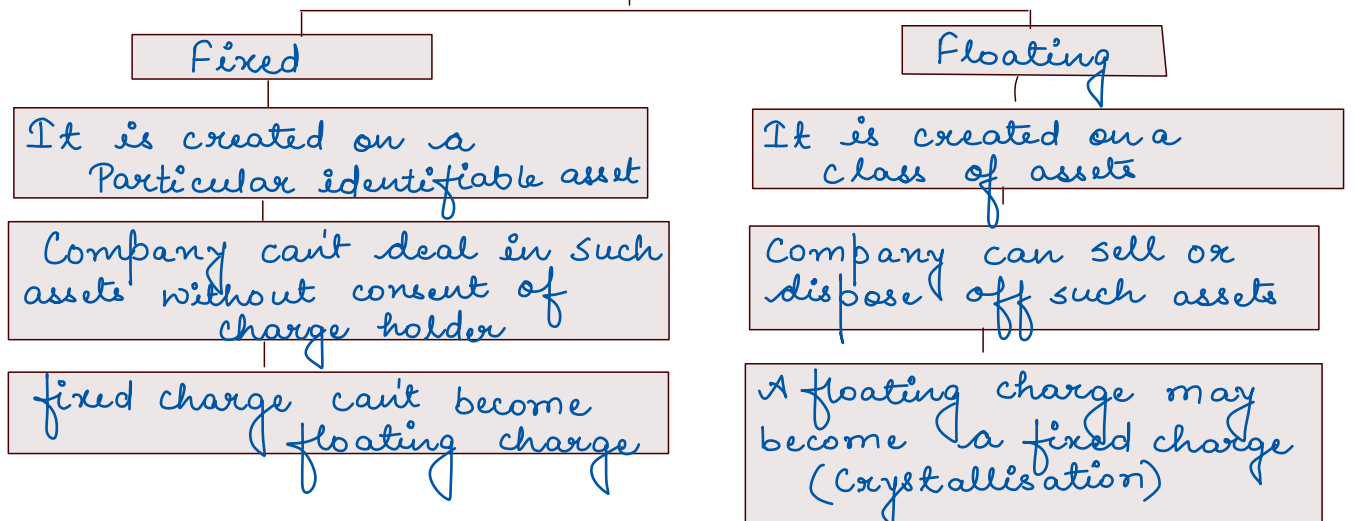

Management & Administration

Chapter VII - containing Section Numbers 88 to 122

Register of Members [Sec. 88]

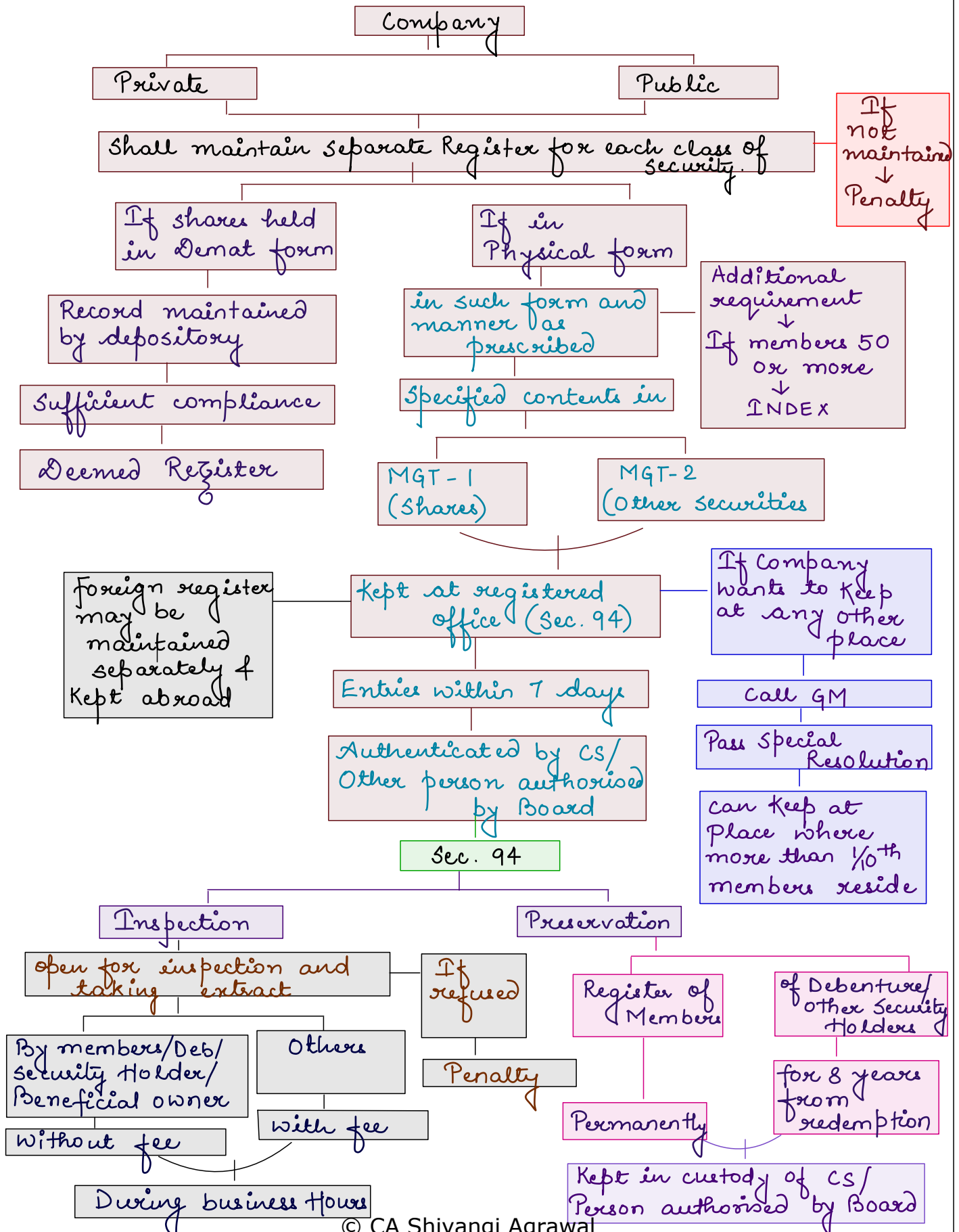

foreign Register [Sec. 88 read with Rule 7]

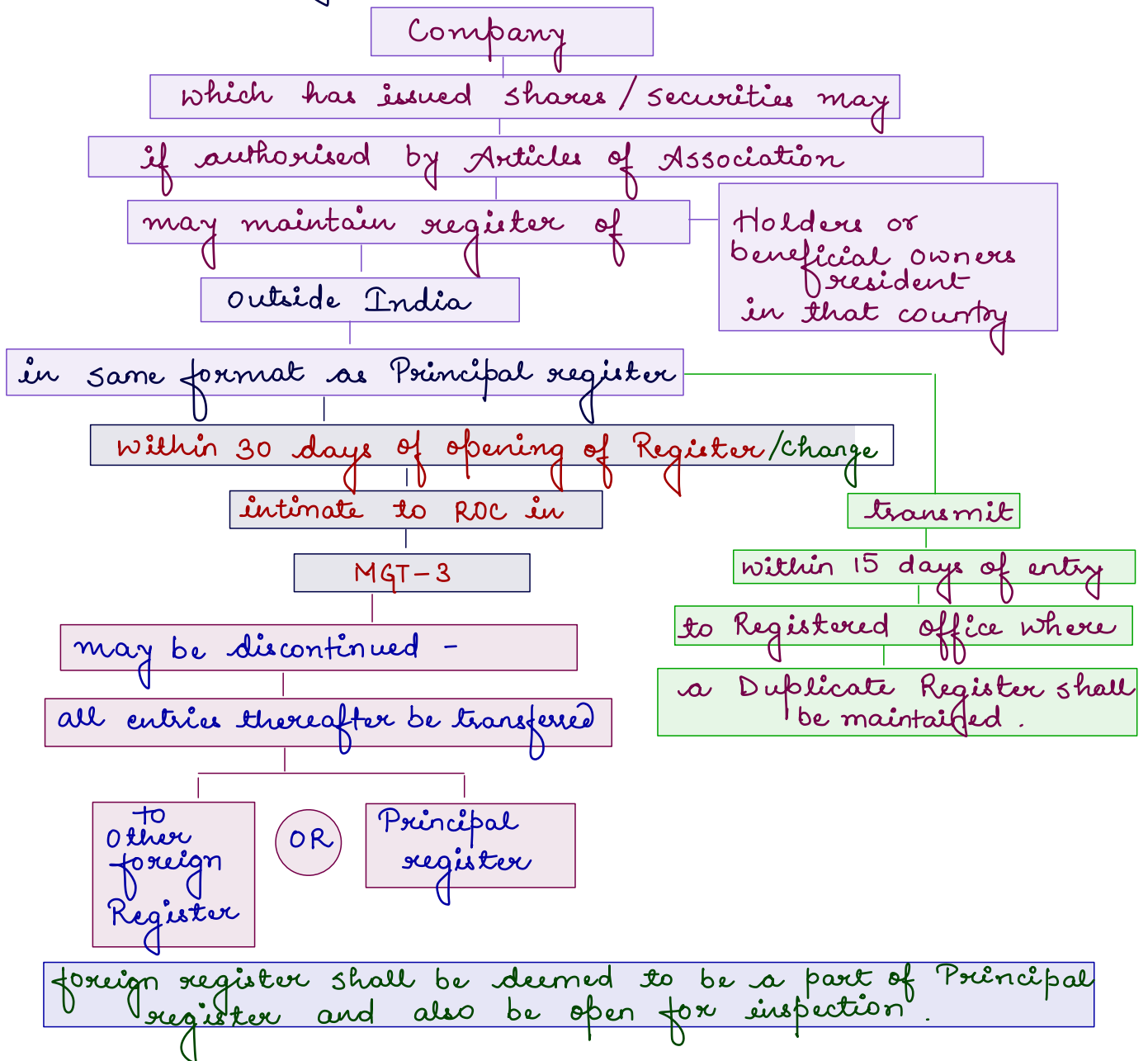

Power to close Register [Sec. 91 read with Rule 10]

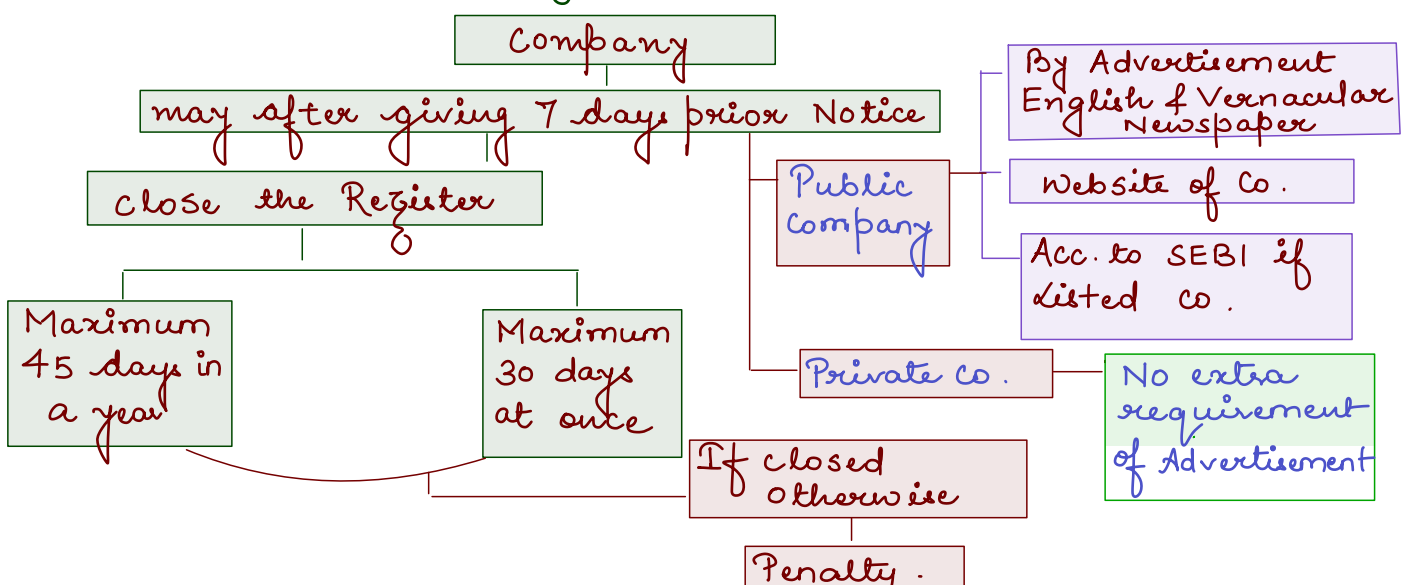

Beneficial Ownership [Sec. 89]

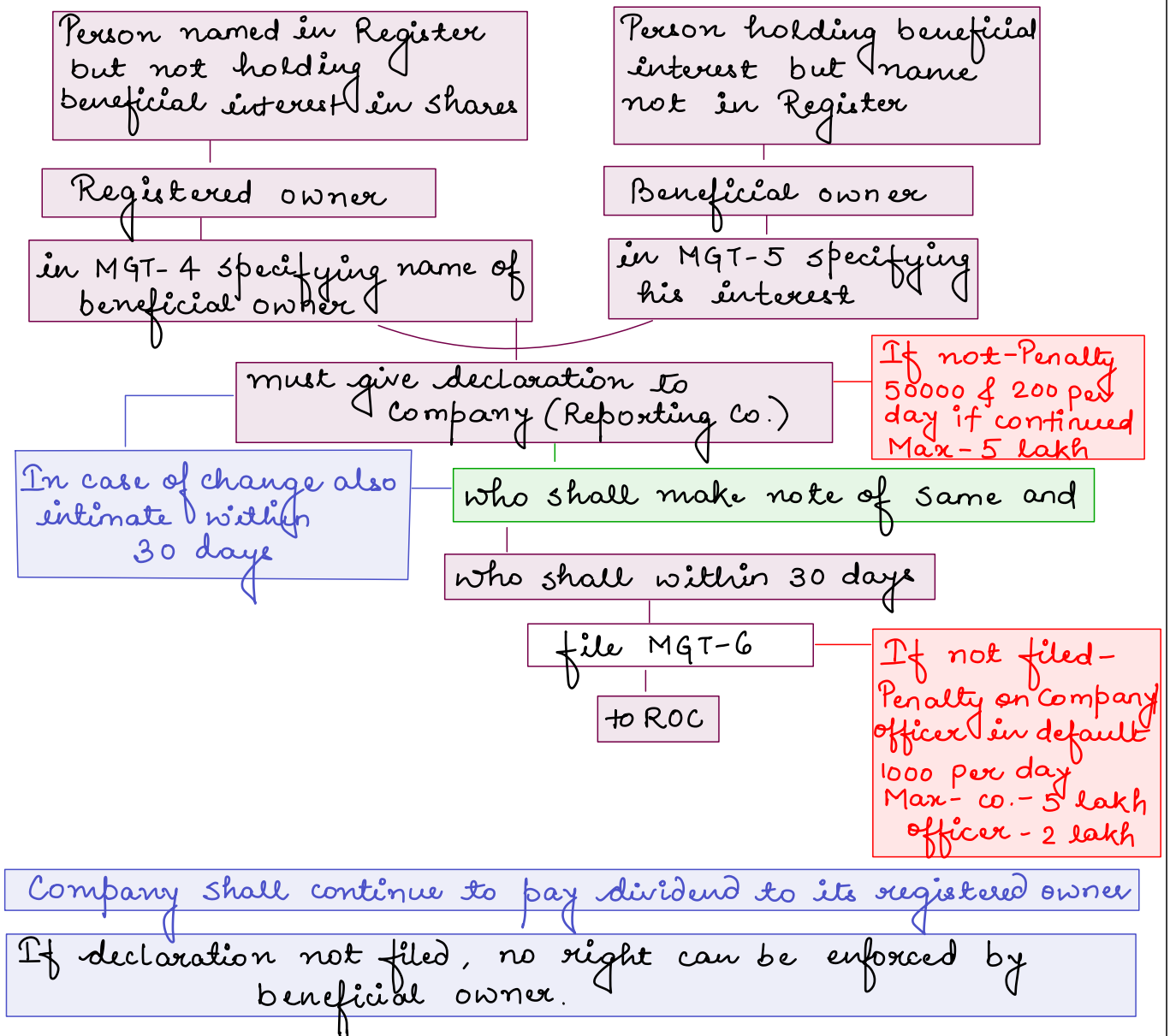

Significant Beneficial Ownership [Sec. 90]

Meaning of SBO (Sec. 90 read with Rule 2(i)(h) of Companies (SBO) Rules, 2018)

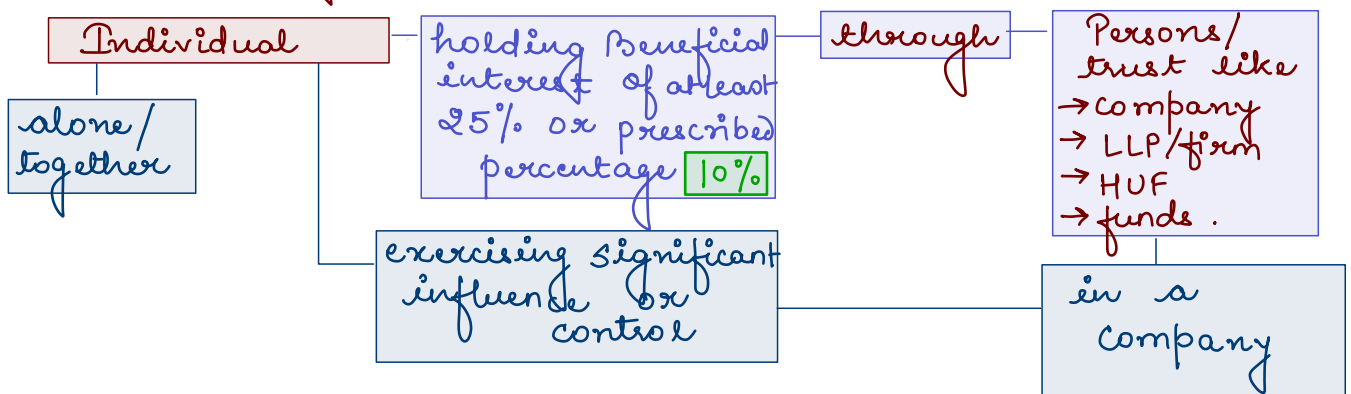

An Individual having direct holding of shares of more than prescribed percentage shall not be Significant Beneficial Owner.

Declaration by SBO [Sec. 90]

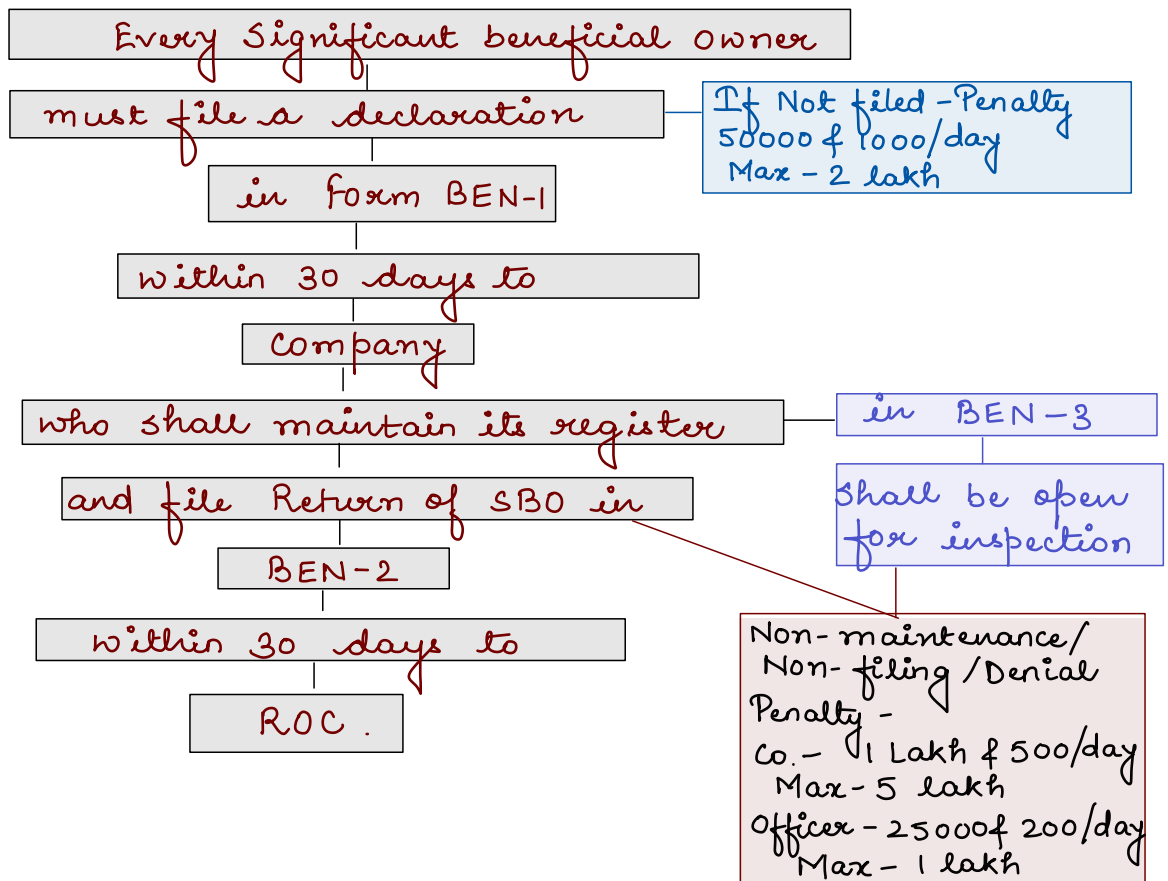

Duty of Company in respect of SBO [Sec. 90]

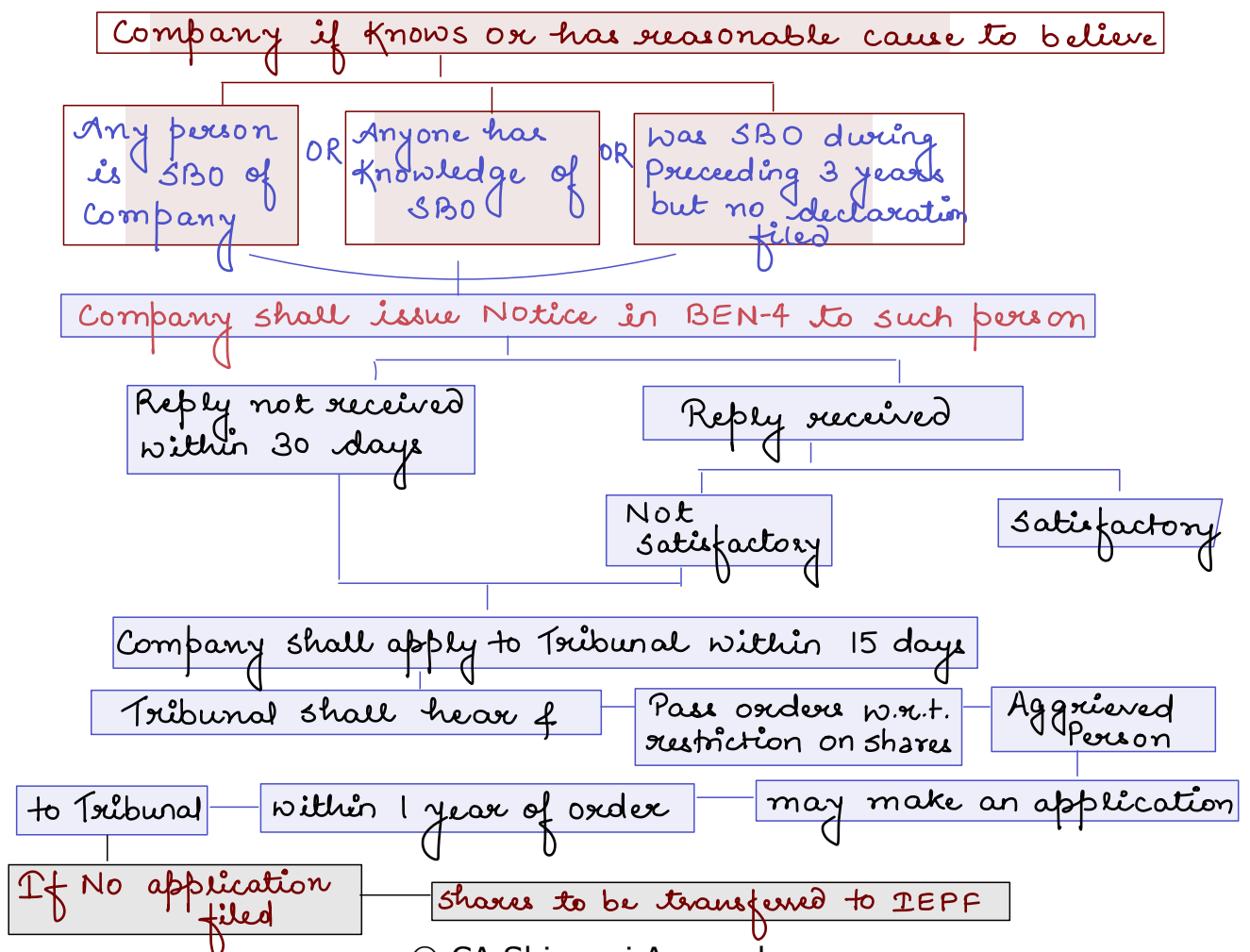

Meetings

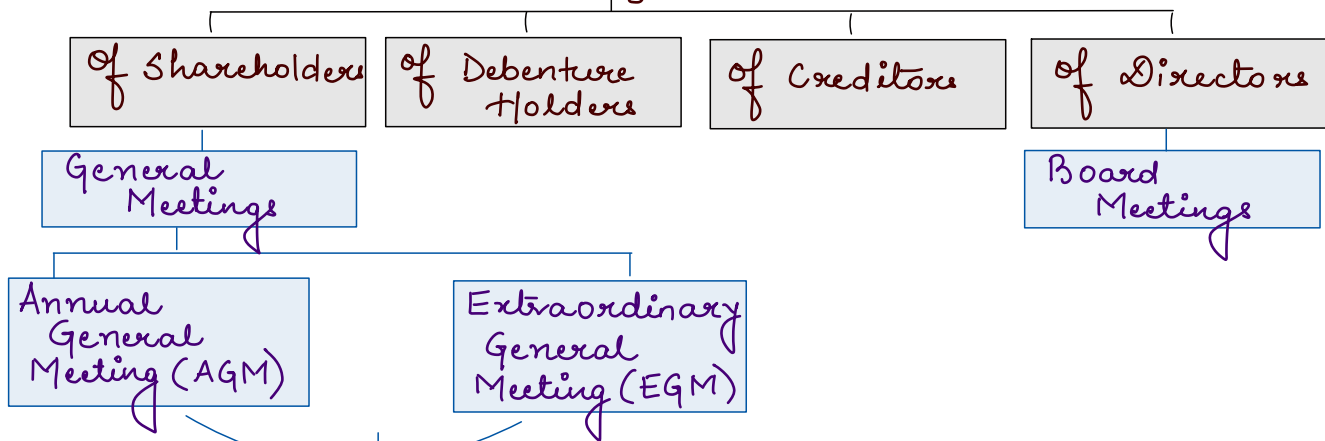

Properly called Properly convened Properly conducted

Pre-requisites of Meeting

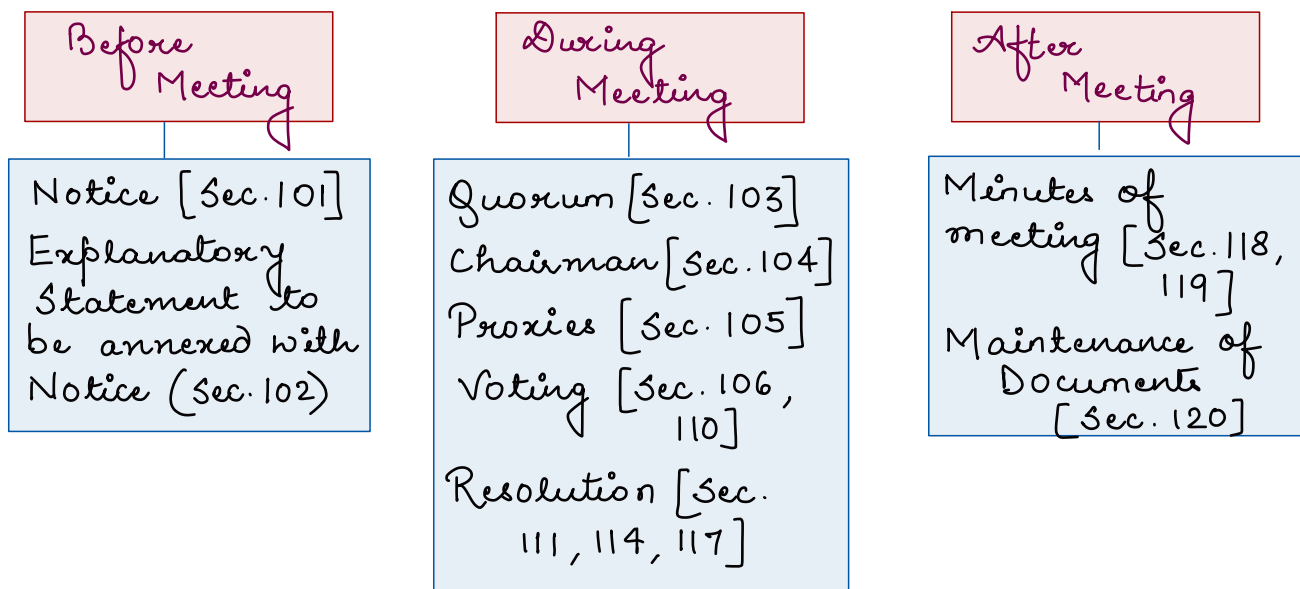

Resolution by Members

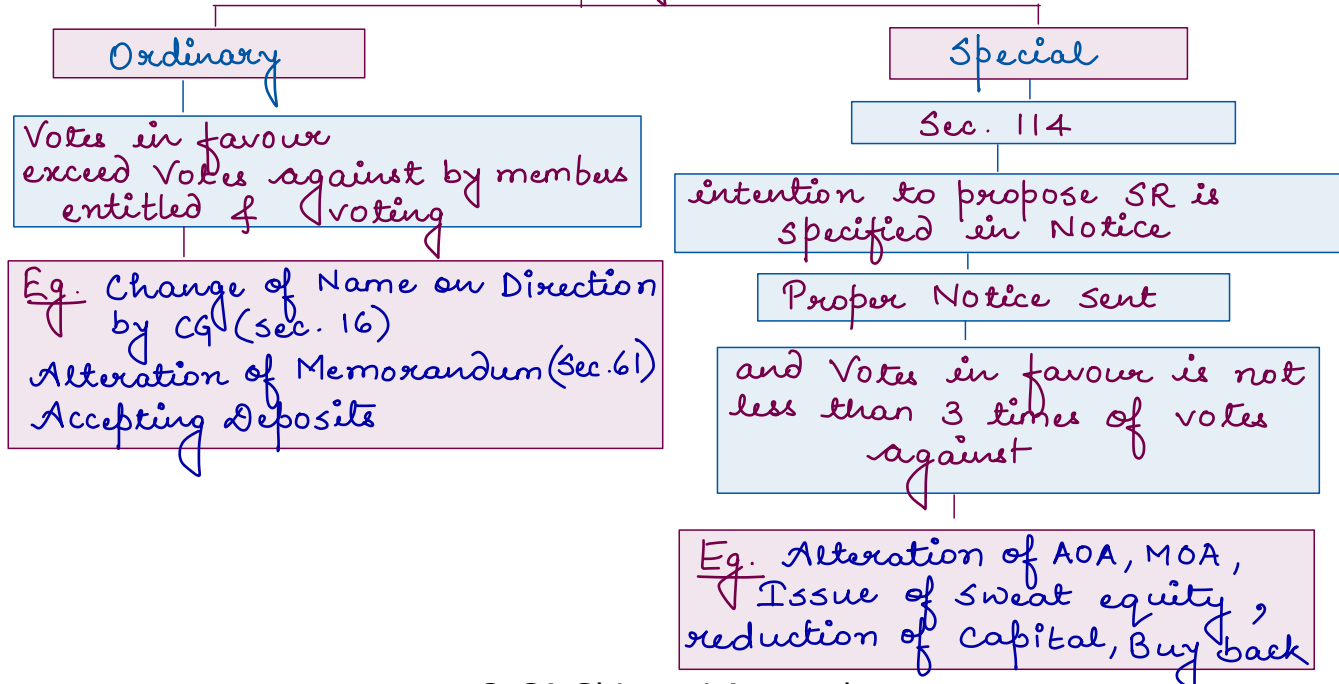

Notice of a Meeting [Sec. 101]

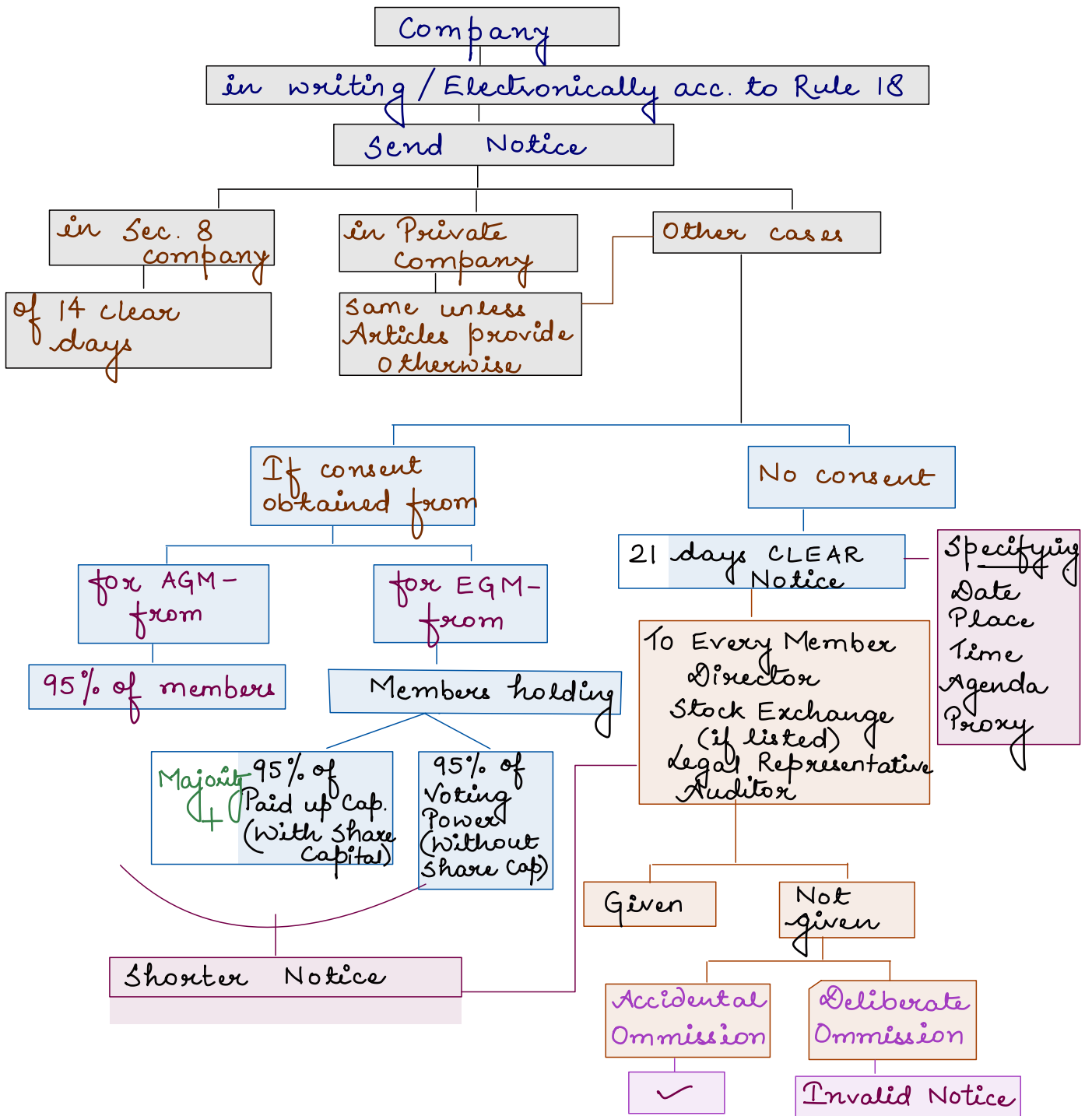

Agenda/Business to be transacted [Sec. 102]

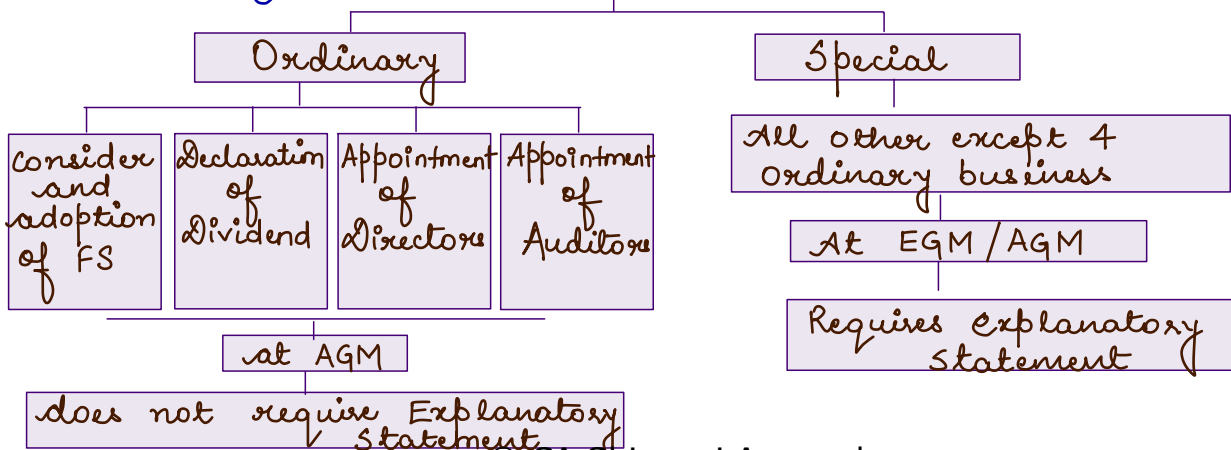

Explanatory Statement

to be annexed with Notice for transacting every special business

Contents

Material facts

Disclosure of interest of Director/KMP

Other relevant information to take decision

If related to other company, shareholding of 2% or more of Director/KMP/Promoter in that Co.

If reference to any document, Date, time and place where it can be inspected.

Compensation and Penalty for insufficient or Non-disclosure.

Quorum (Sec. 103)

Private Company

Higher of -

2 members personally present

OR

No. prescribed by Articles

Public Company

Higher of -

limit or

No. prescribed by Articles

5 if Members ≤ 1000

15 if Members $> 1000 \leq 5000$

30 if Members > 5000

Quorum to be present within 1st half n hour of meeting

Yes

No

If EGM was called by requisitionists

Meeting stands cancelled

Other cases

Adjourned to

Same day, Place, time of Next week

OR

As determined by board

by giving 3 days Notice

Individually

OR

Through Advertisement

Proxy - Not counted for Quorum

Quorum must only at commencement Not required throughout meeting.

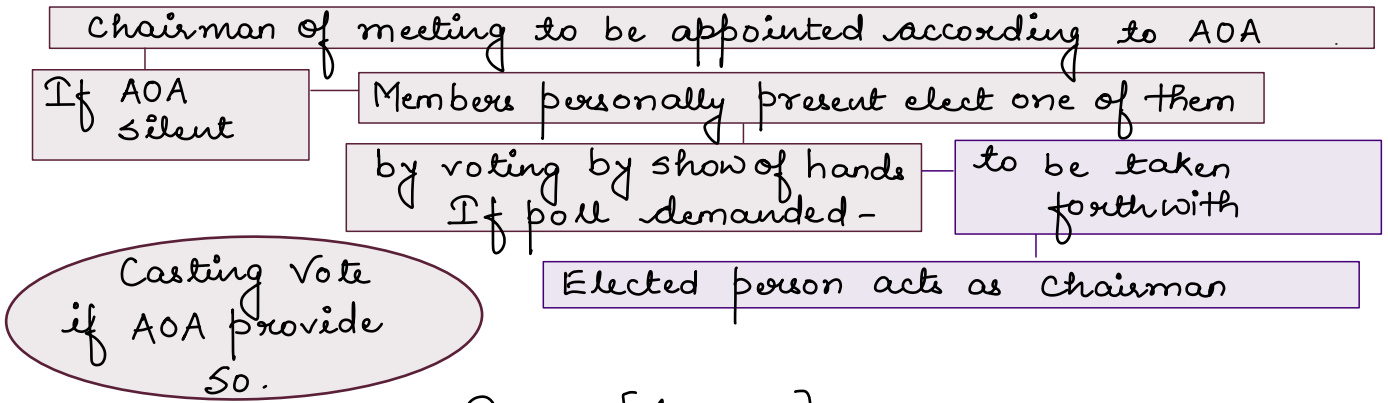

Proxy [Sec. 105]

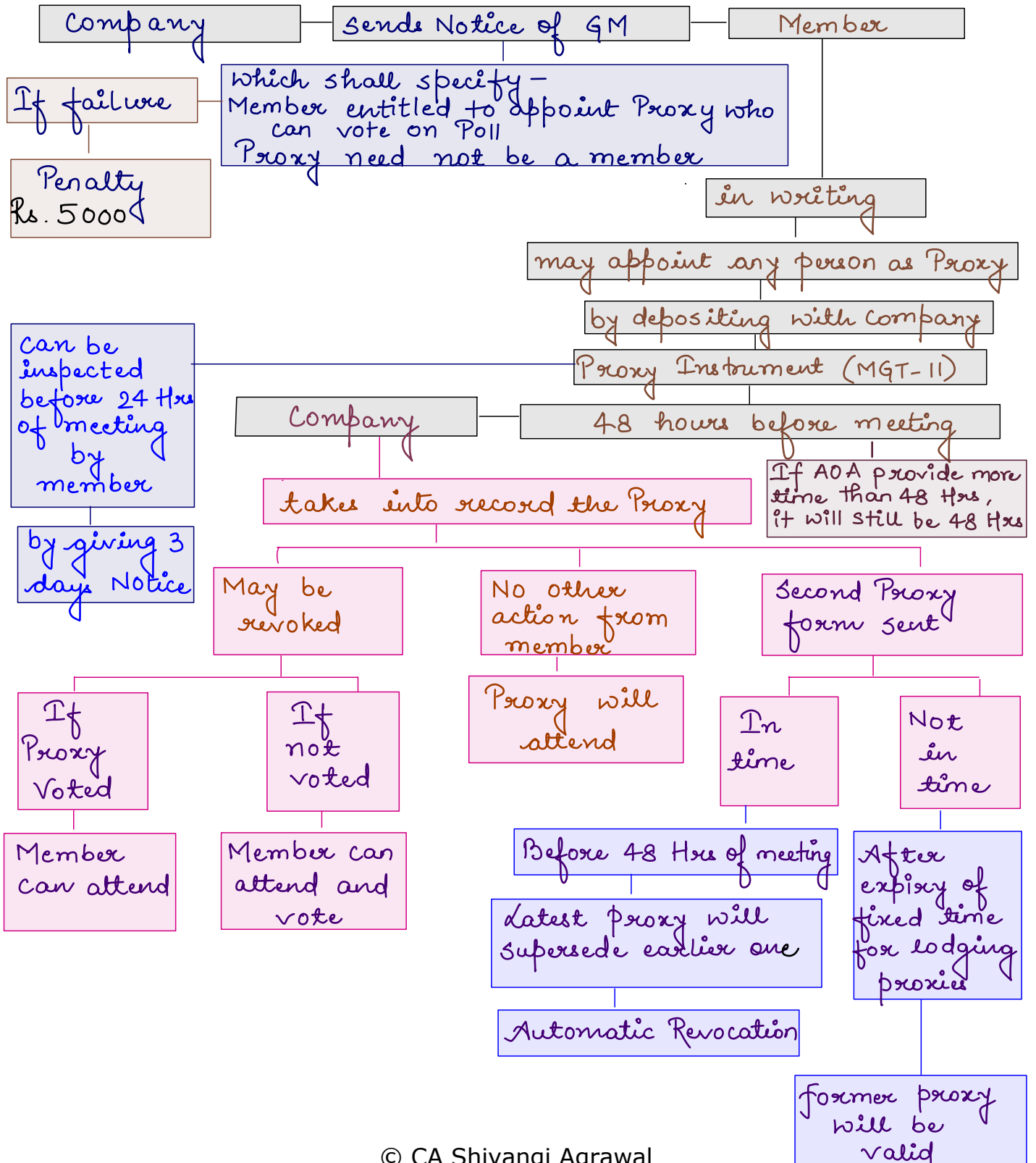

Proxy - No right to speak at meeting.
 can't vote on show of hands.
 Not counted for Quorum.
 Right to vote on Poll.

One Person can become a Proxy -
 → of not more than 50 members. and
 → holding not more than 10% of Share capital with voting rights.

Voting

Member/Proxy may use his votes differently on a Poll (Sec. 106)

Voting rights can be restricted if authorised by AOA on the ground of Non-payment of call/sums due.

Manner of Voting

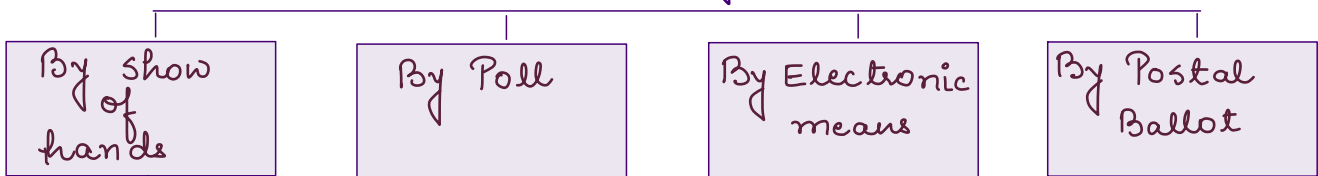

A resolution shall be decided by show of hands - (At GM) unless poll demanded u/s 109 or Voting carried out electronically u/s 108.

Voting by Poll in Meeting [Sec. 109]

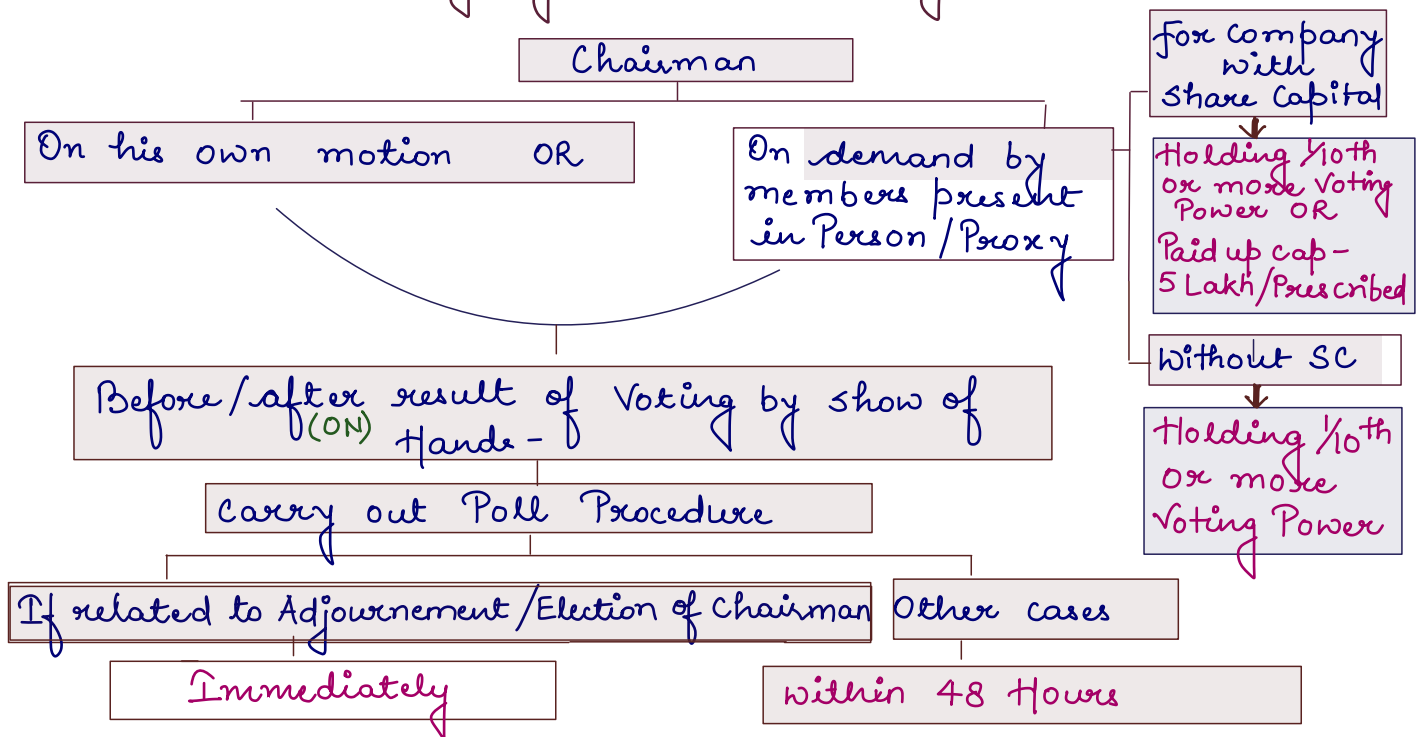

Procedure of Poll

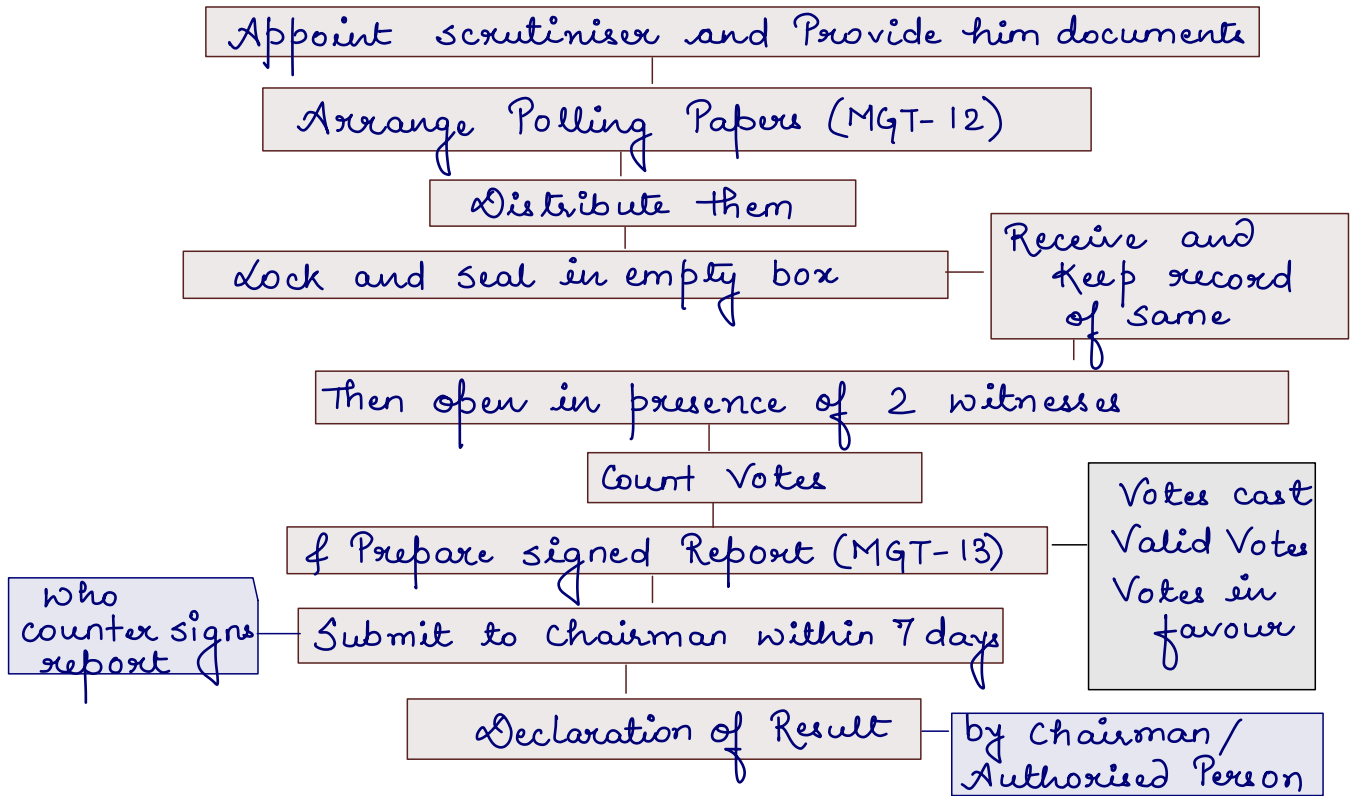

Voting by Electronic means [Sec. 108]

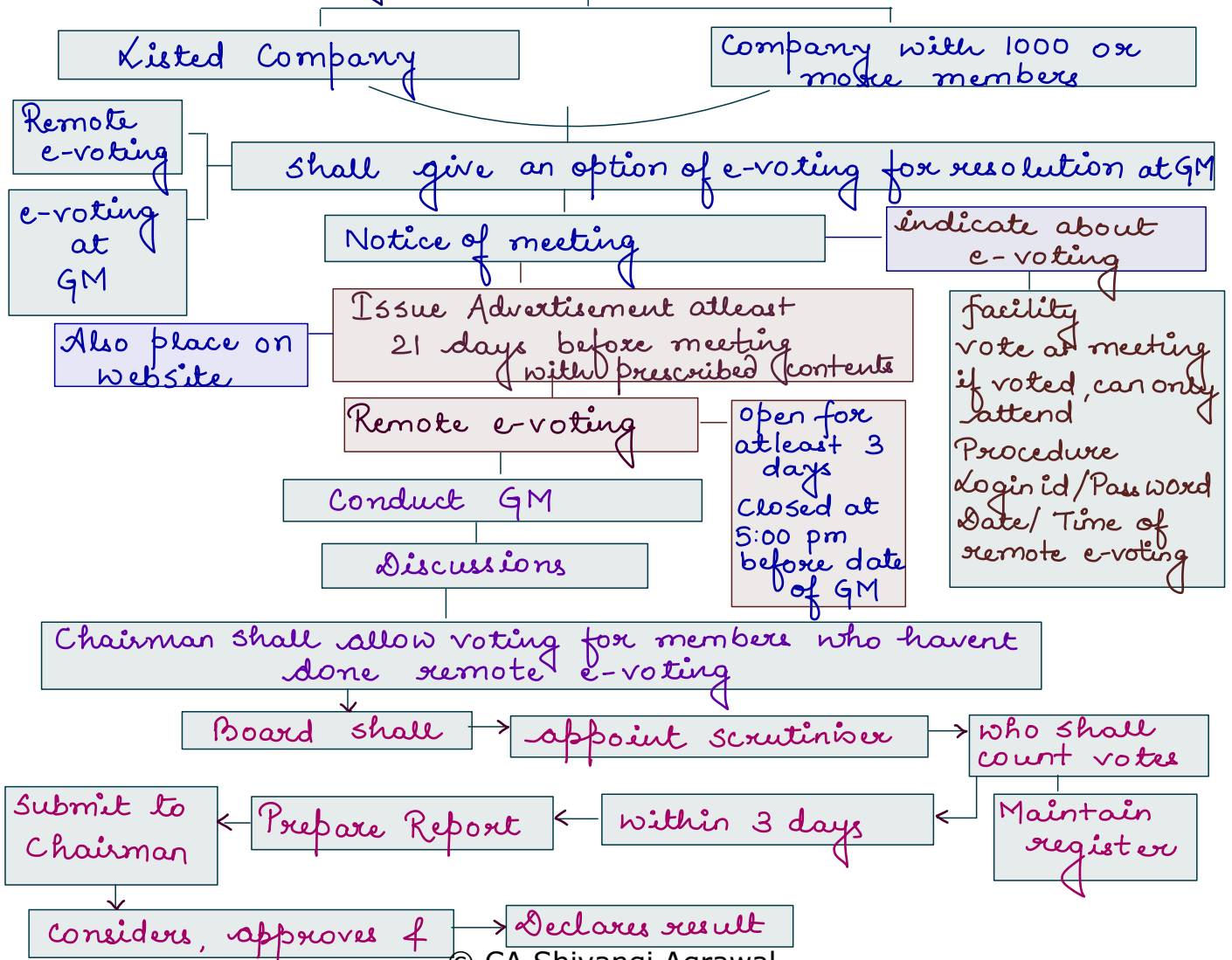

Voting by Postal Ballot (Sec. 110 read with Rule 22)

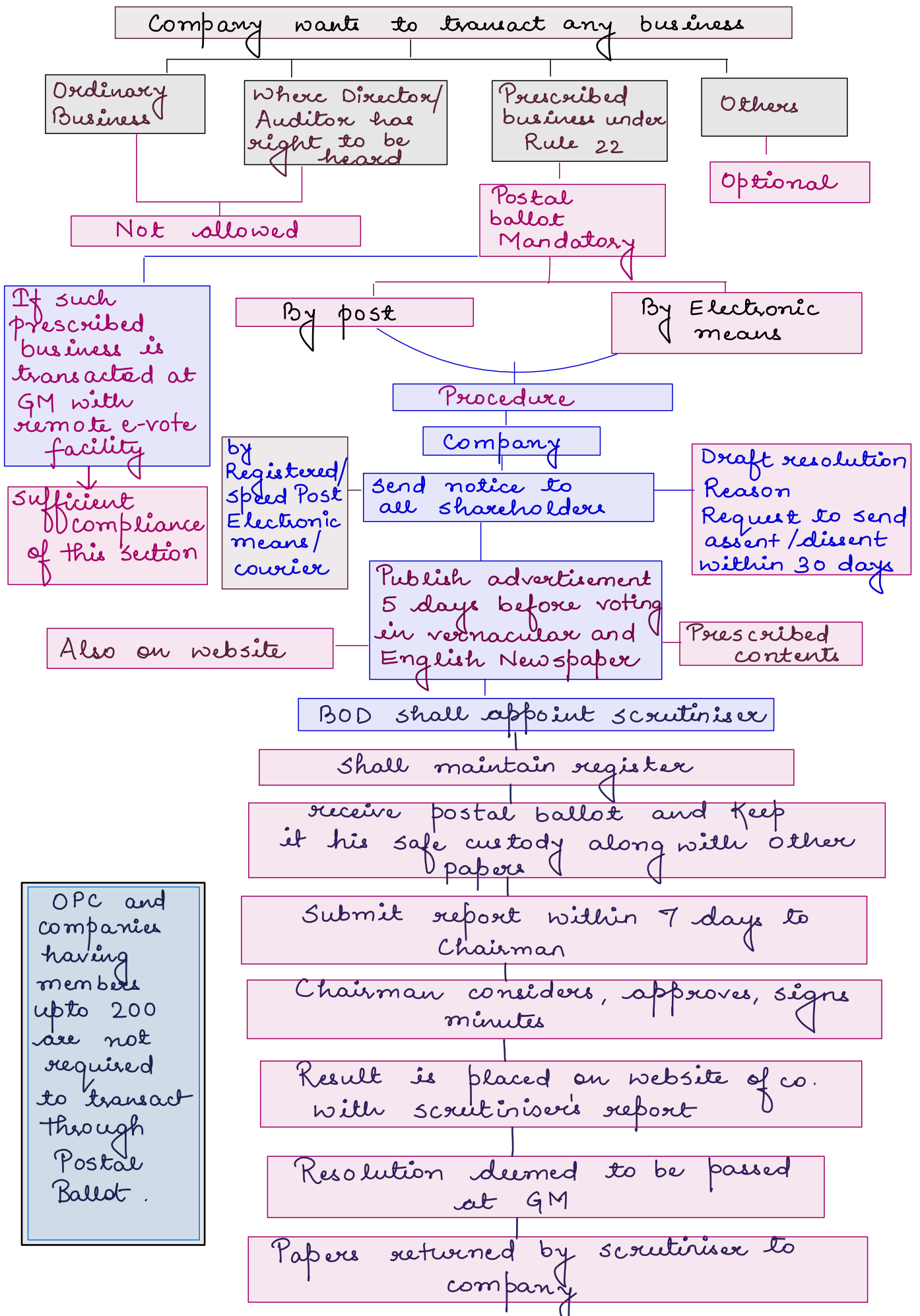

Mandatory - Postal ballot in following cases :-

- Alteration in Object Clause
- " in AOA → to make Private company
- Shifting of registered office outside city.
- variation in objects when money from Prospectus unutilised.
- Issue of shares with DVR
- Variation of rights
- Buy back
- Election of Director (Sec. 151) [Small Shareholder's Director]
- Sale of Undertaking (Sec. 181)
- extending lease (Sec. 186)

Annual General Meeting [Sec. 96]

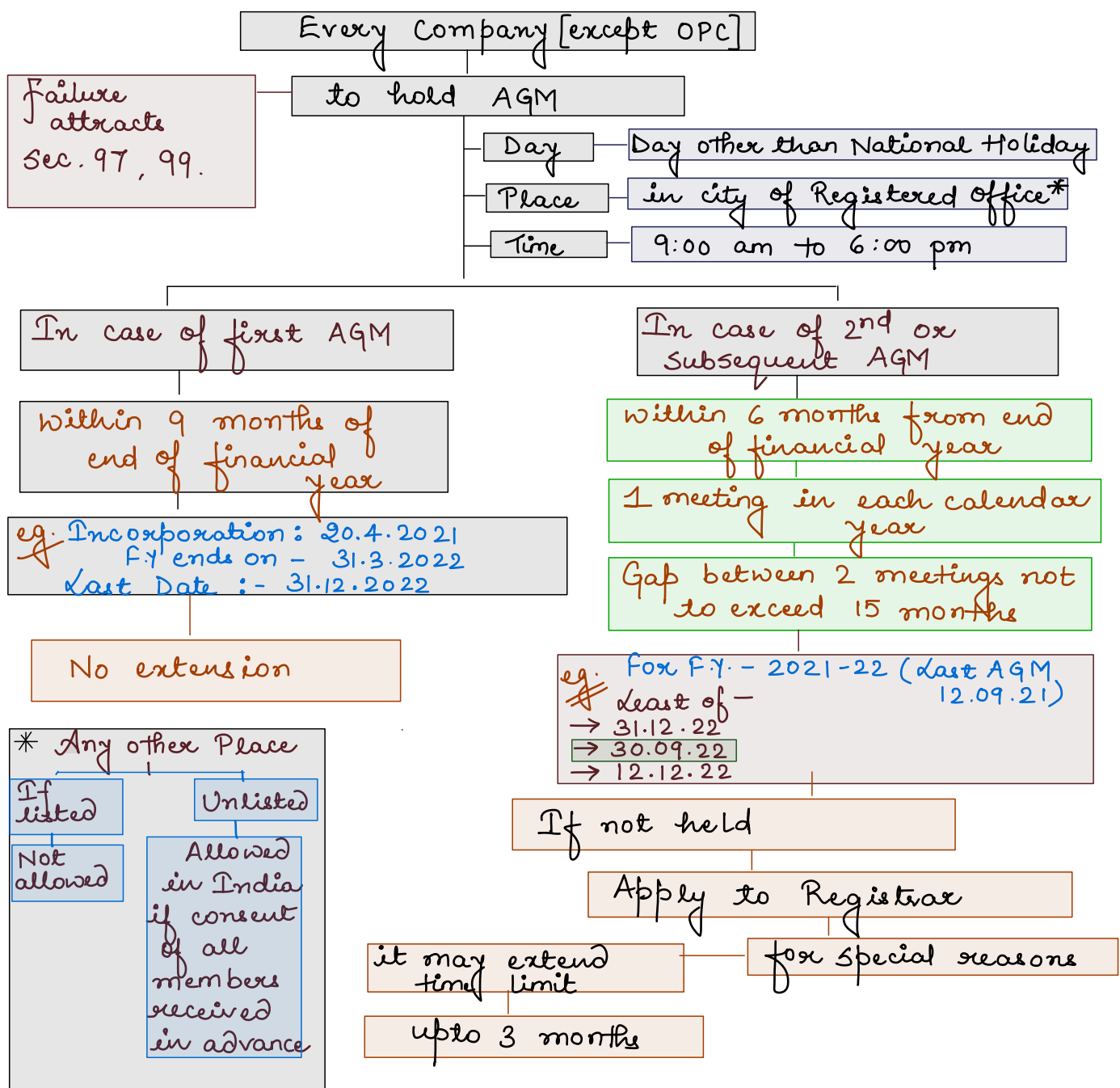

AGM/EGM not required for OPC
Communicate decision to member & prepare minutes

Failure to hold AGM (Sec. 97)

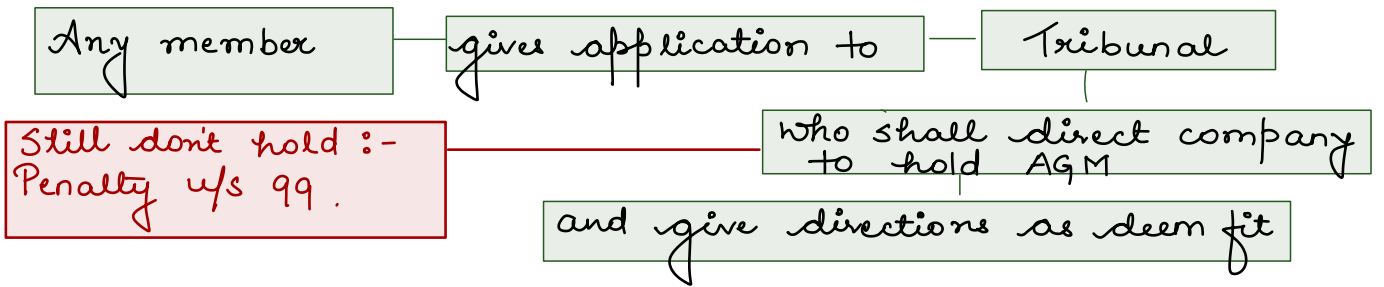

Report on AGM [Sec. 121]

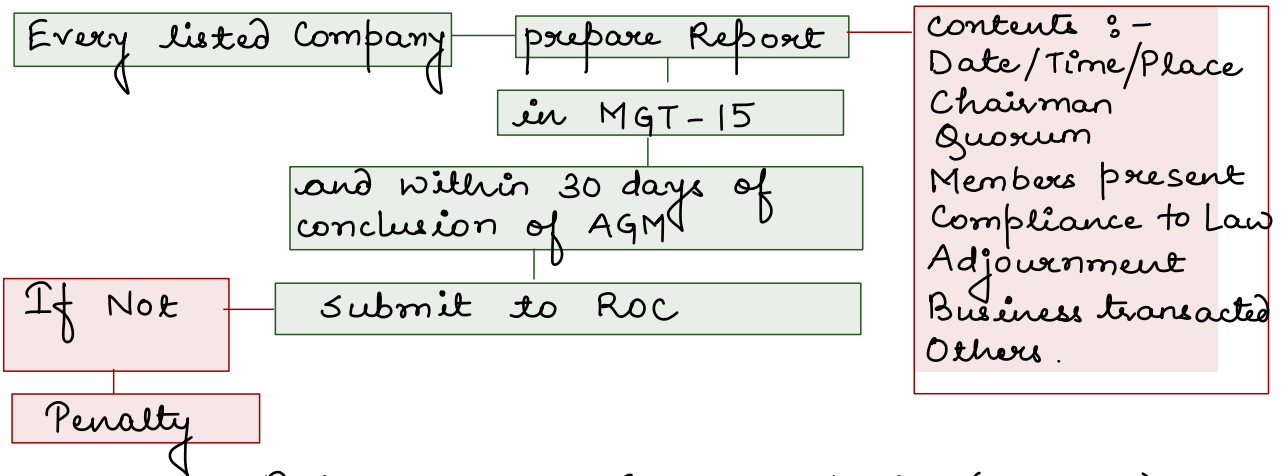

Extra Ordinary General Meeting (Sec. 100)

Who can call EGM ?

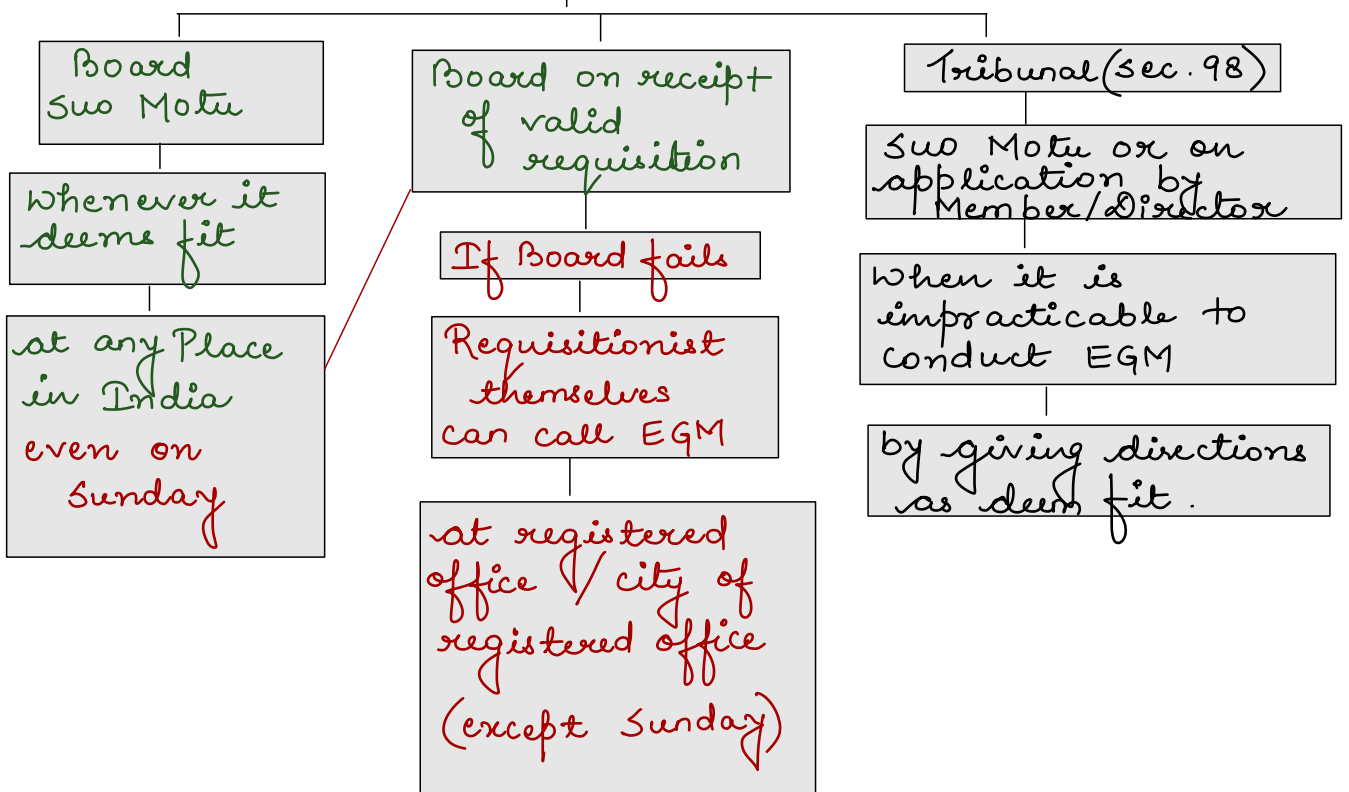

EGM by eligible members

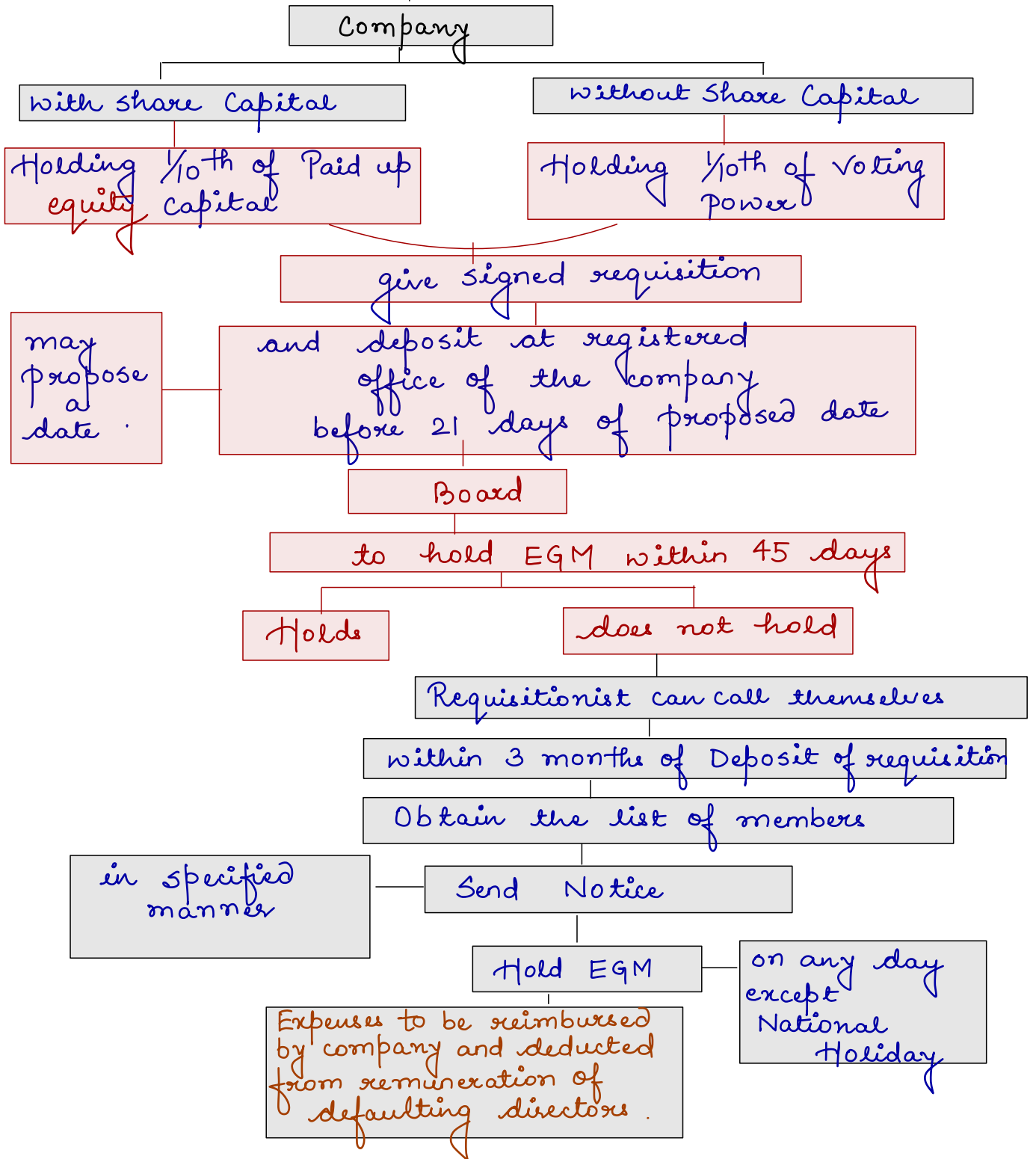

Circulation of Members Resolution (Sec. 111)

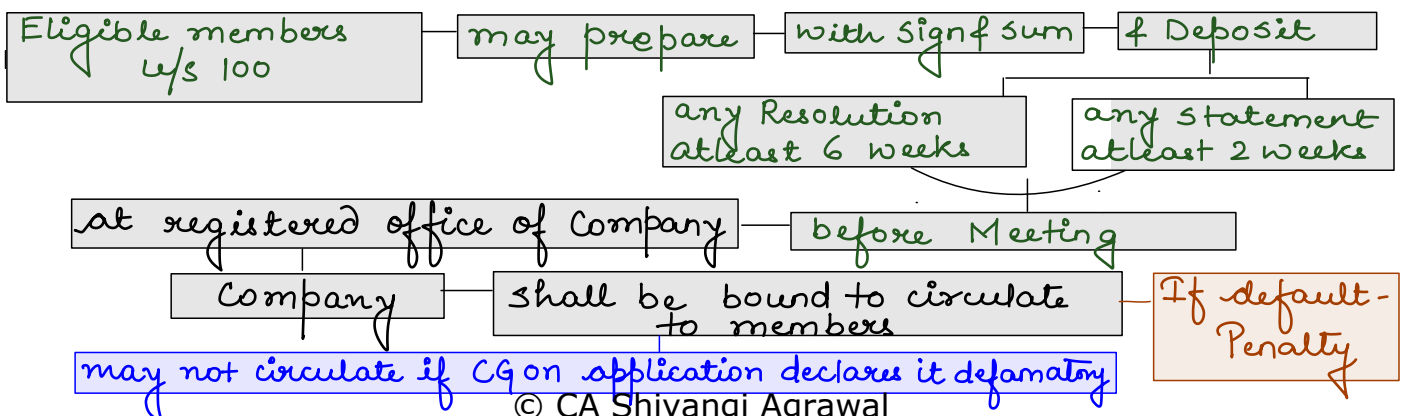

All special resolution along with other specified Resolutions must be filed with ROC within 30 days of passing resolution in MGT-14 (Sec. 117)

Resolutions requiring Special Notice (Sec. 115)

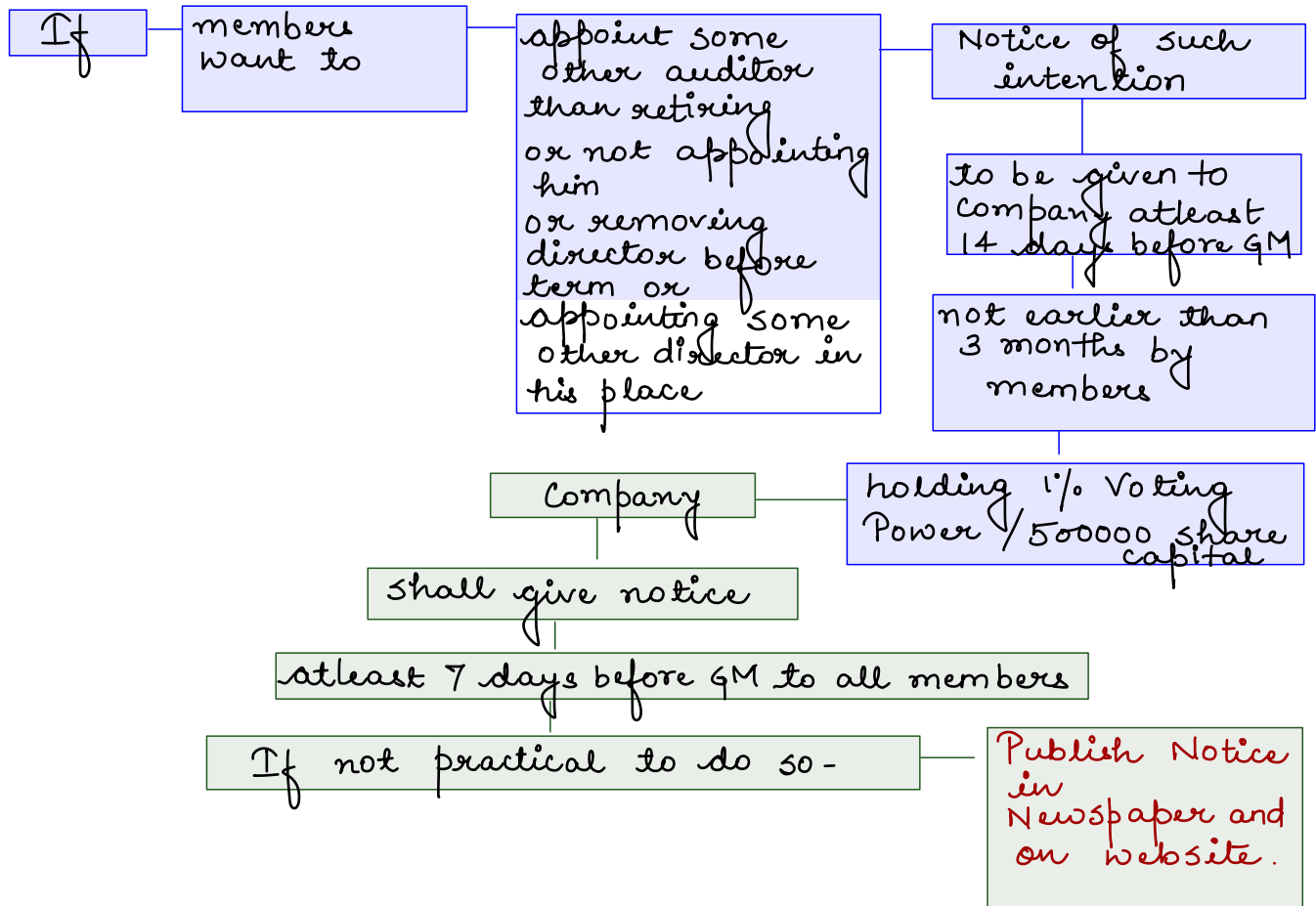

Minutes of Meeting [Sec. 118, 119]

Separate Minute book for each type of meeting

signed, dated, consecutively numbered

Preserved Permanently

Signing by chairman

Kept at registered office

fair & correct summary

Not loose pages

Prepared and signed within 30 days of conclusion of meeting

Open for inspection during business hours by members without charge

Annual Return [Sec. 92]

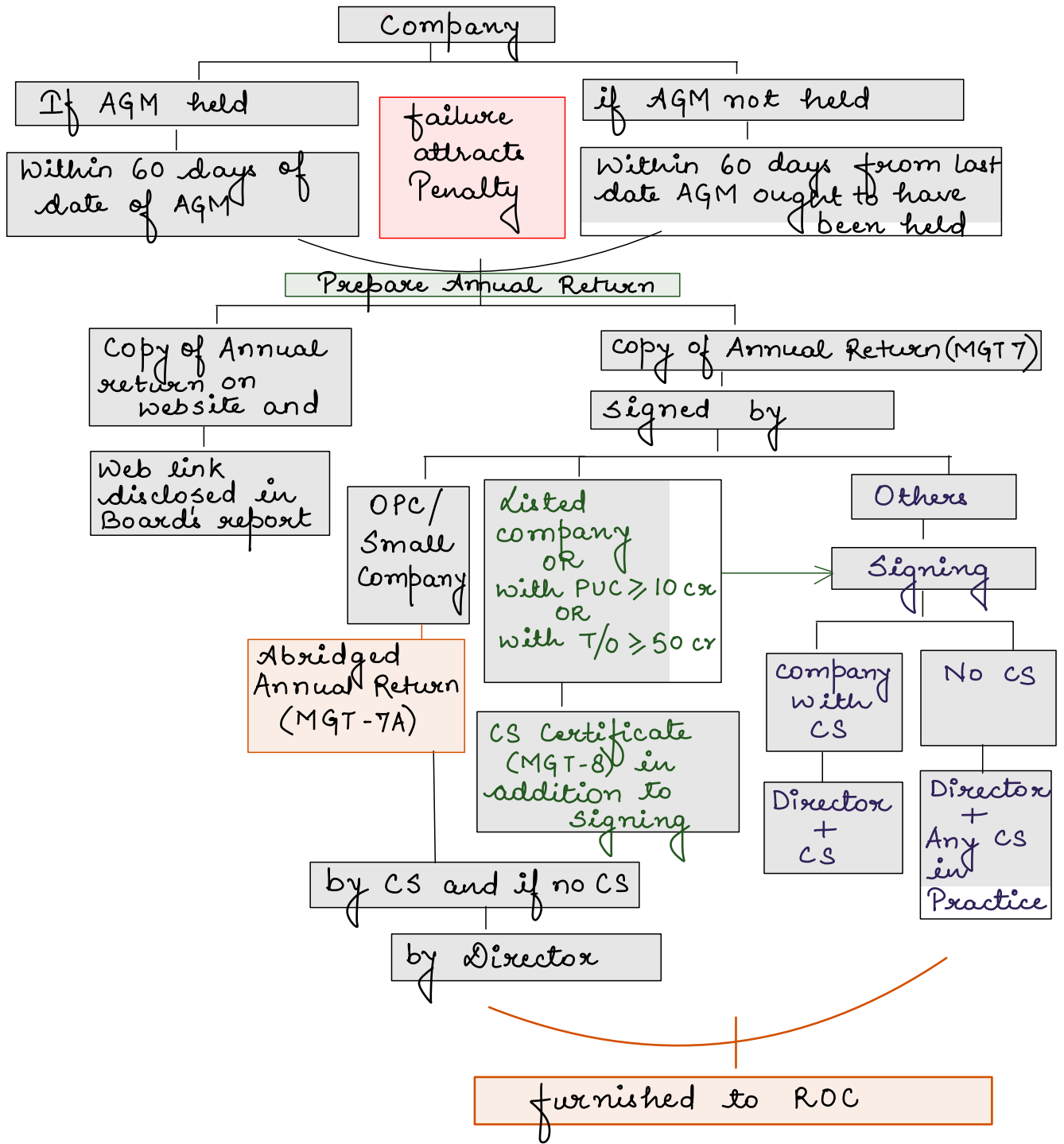

Failure to file Annual Return :-
 Company - 10000 + 100 per day (Max = 2 lakhs)
 Officer in default - 10000 + 100 per day (Max = 50000)
 CS certifies not in conformity with law
 Penalty = 2 lakh

Declaration & Payment of Dividend

Chapter VIII (containing sections 123-127)

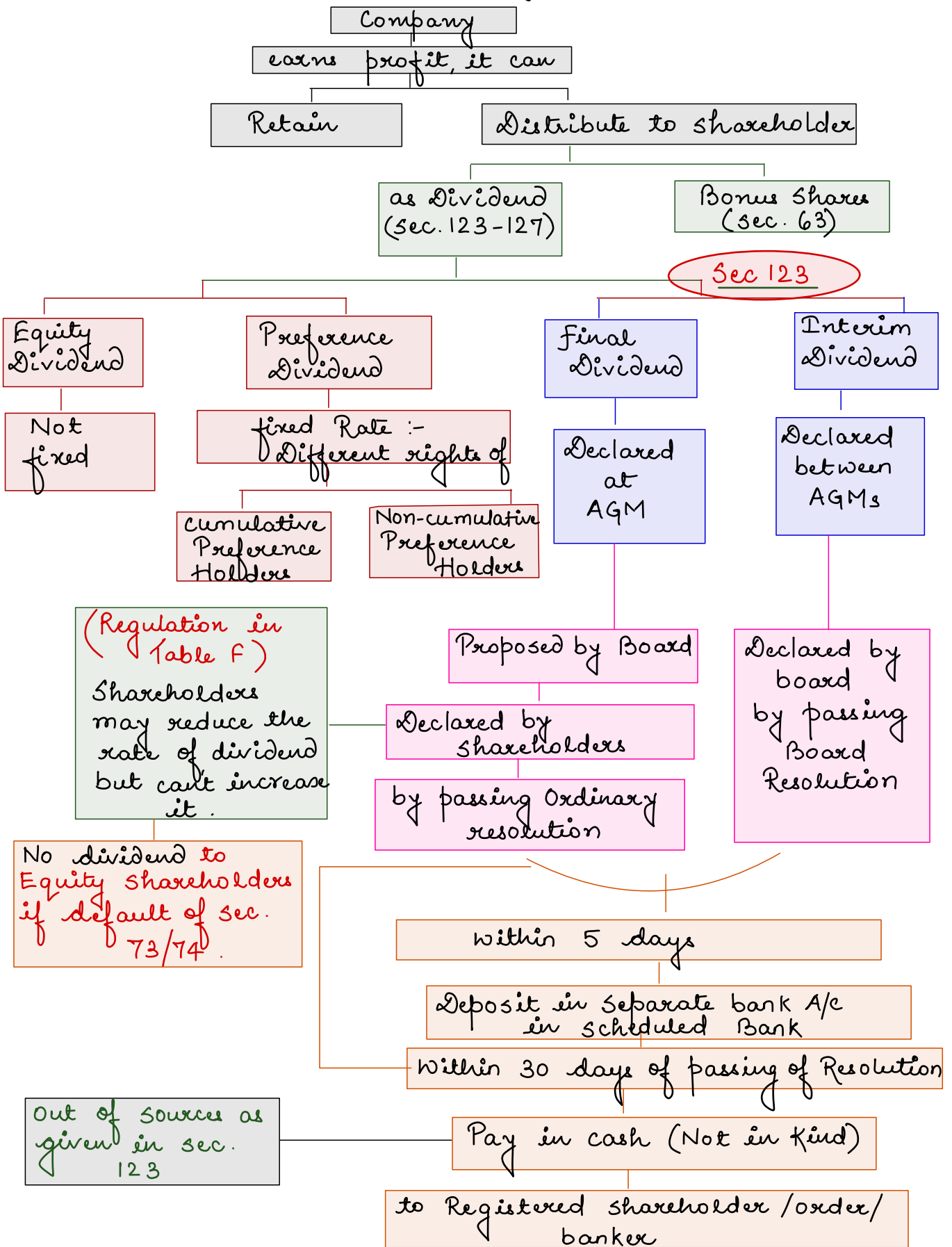

Interim Dividend

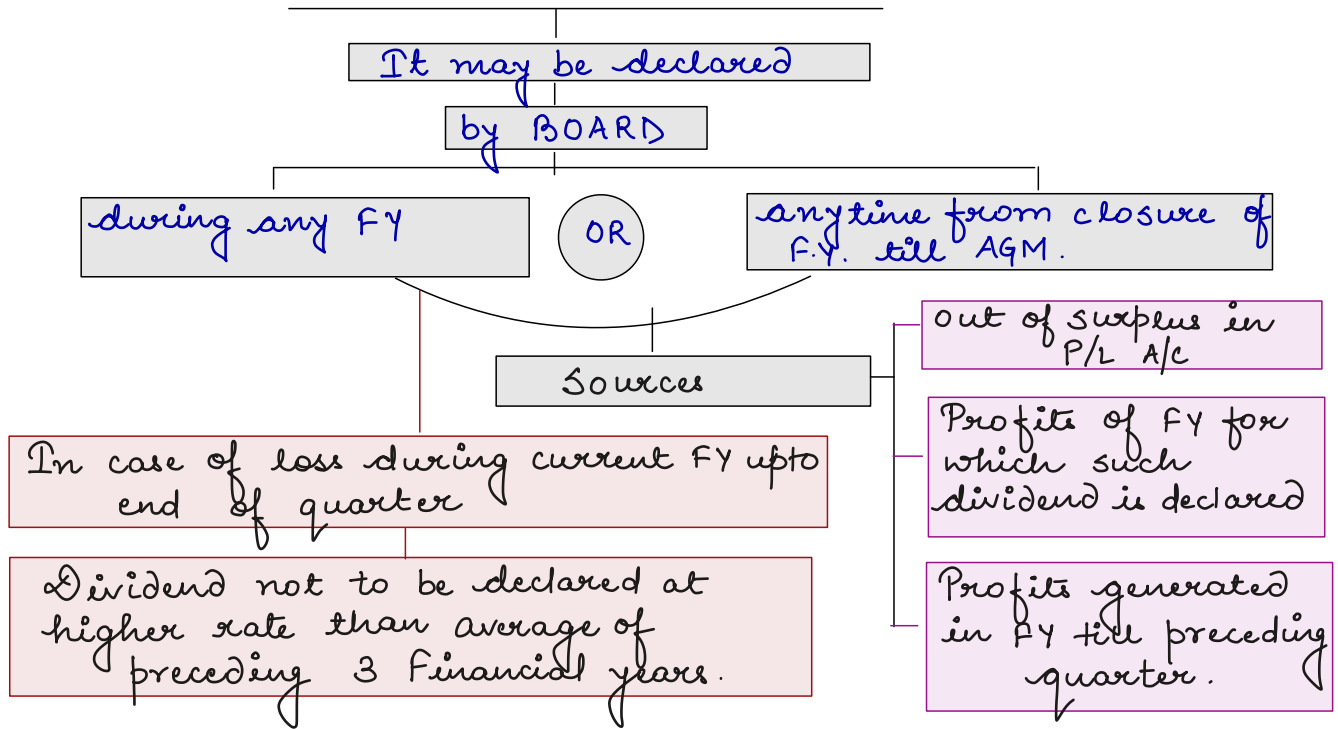

Sources of Dividend

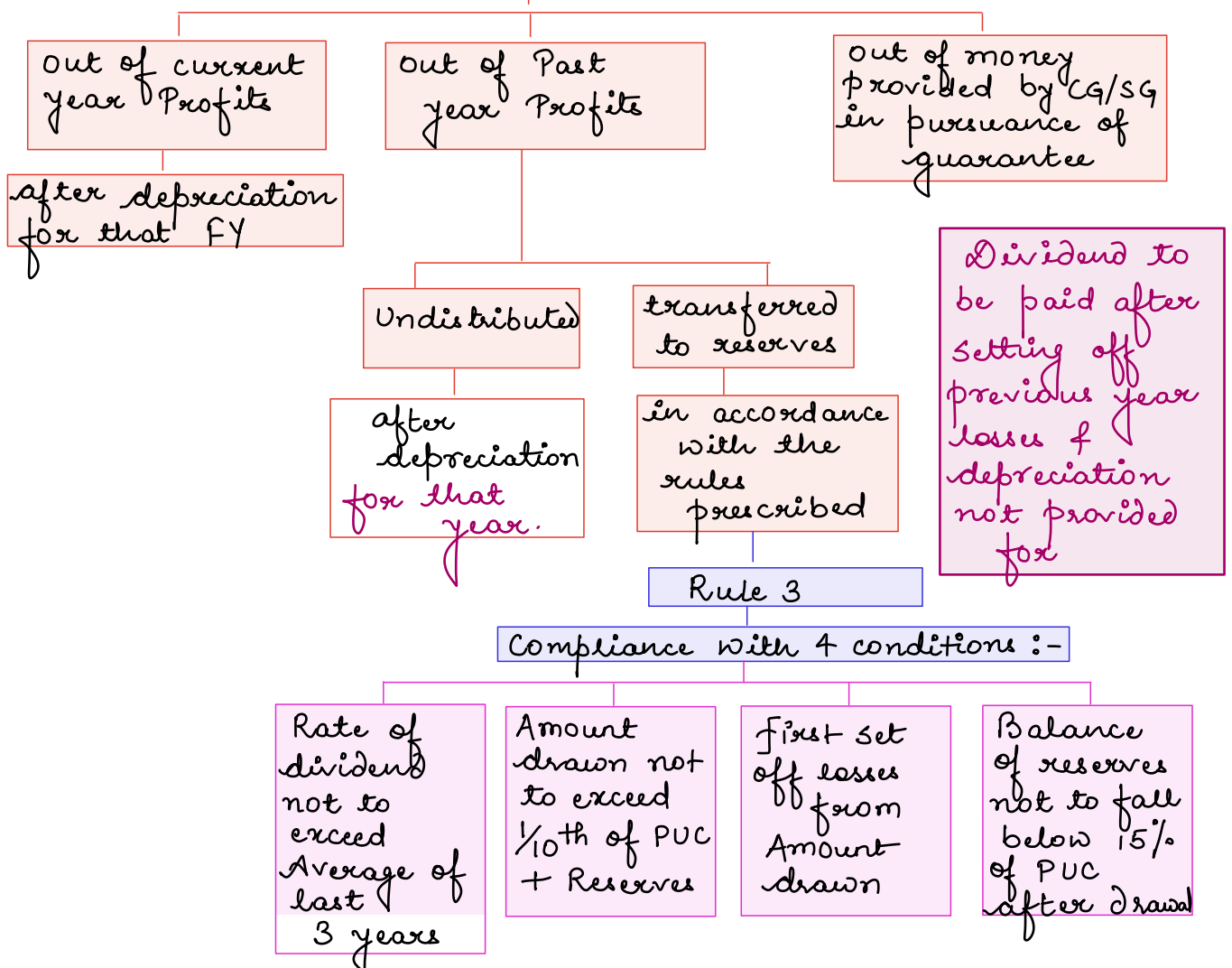

Unpaid Dividend (Sec. 124)

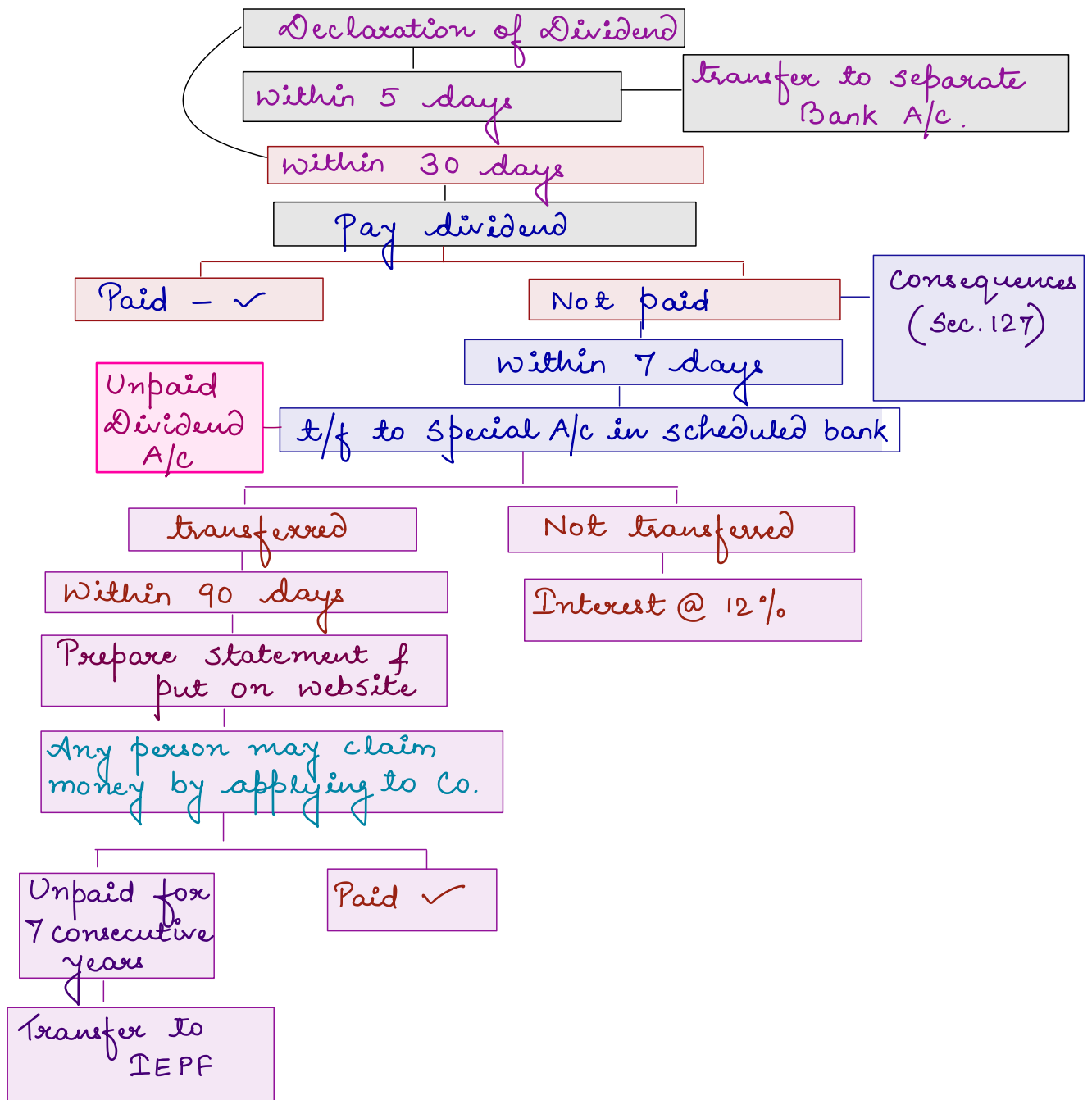

Investor Education & Protection Fund (IEPF) [Sec. 125]

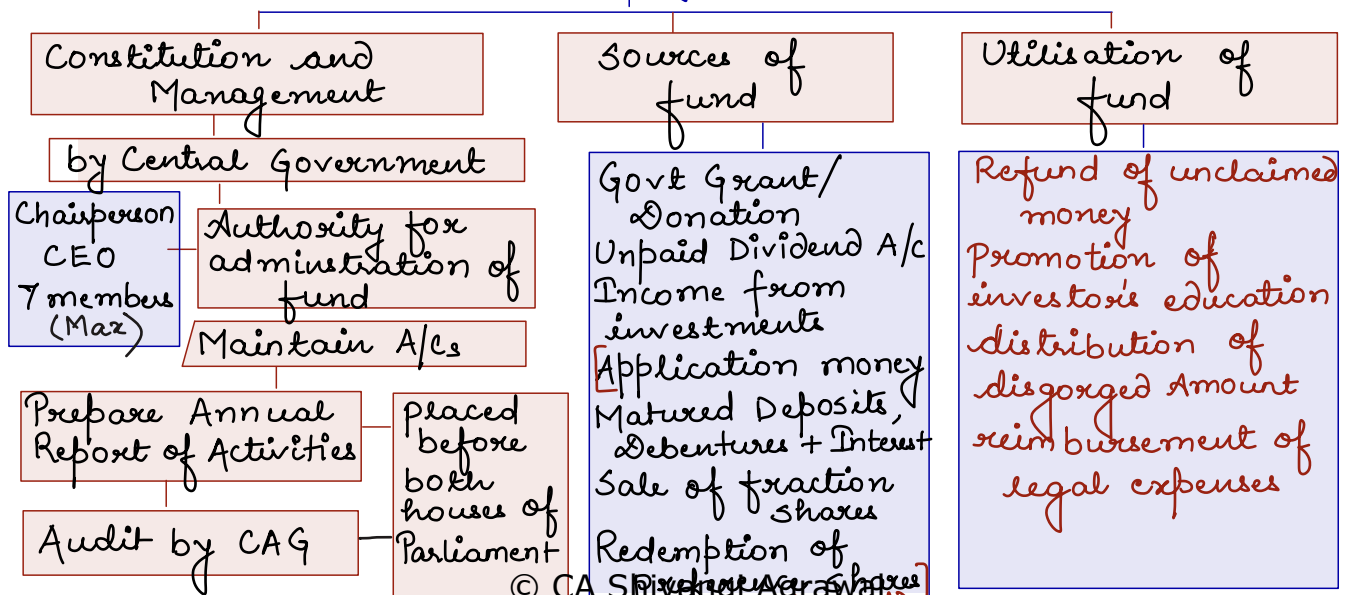

Failure to distribute Dividend [Sec. 127]

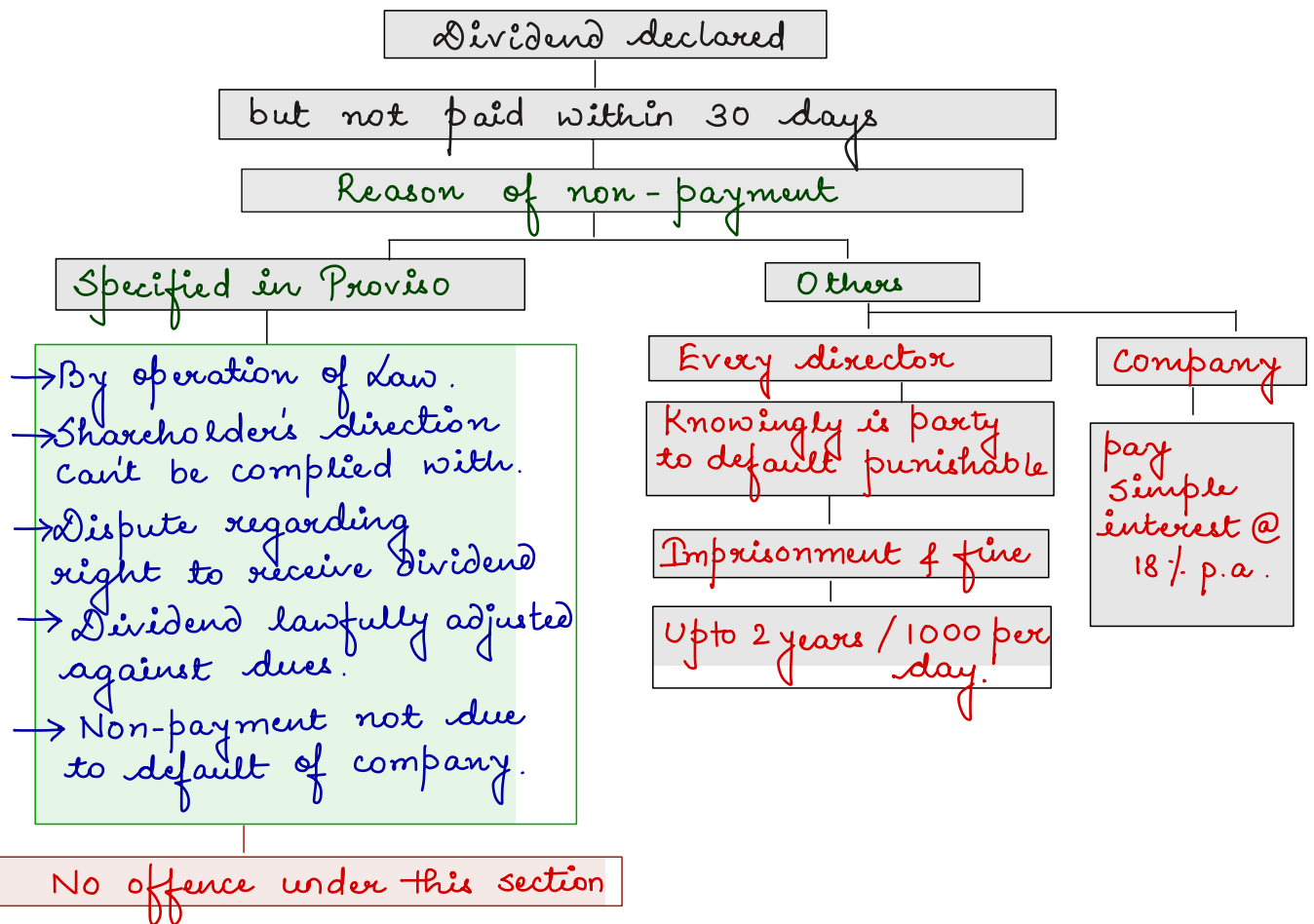

Other Points related to Dividend :-

If transfer not registered, pay to transferee if authorised by registered holder in writing or else transfer to Unpaid dividend A/c [Sec. 126]

Dividend once declared can't be revoked.

Time limit :-

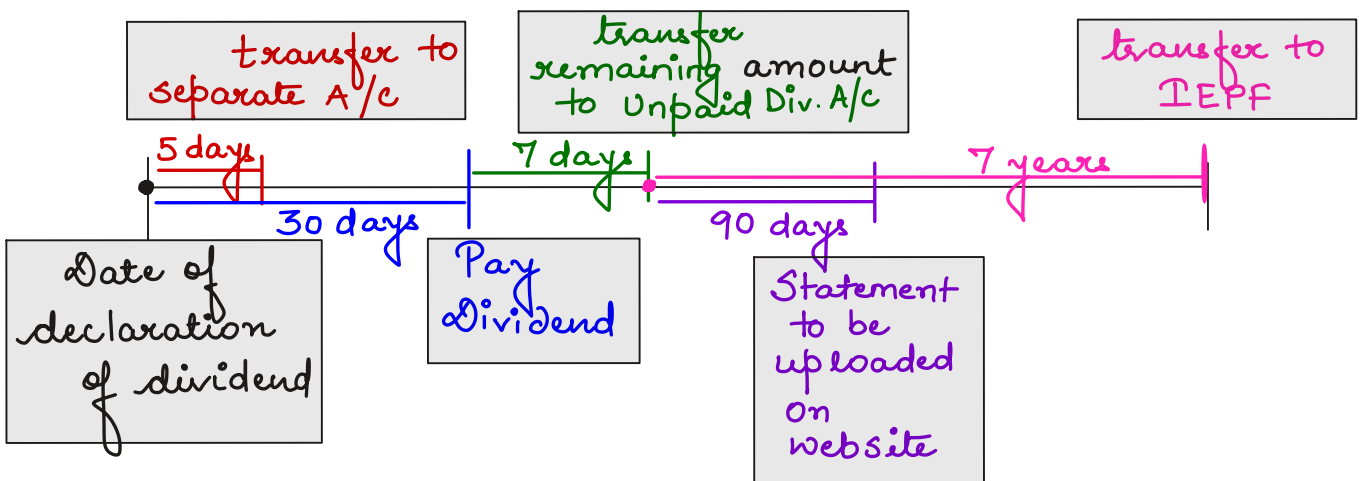

Accounts of Companies

Chapter IX (containing Sec. 128 - 138)

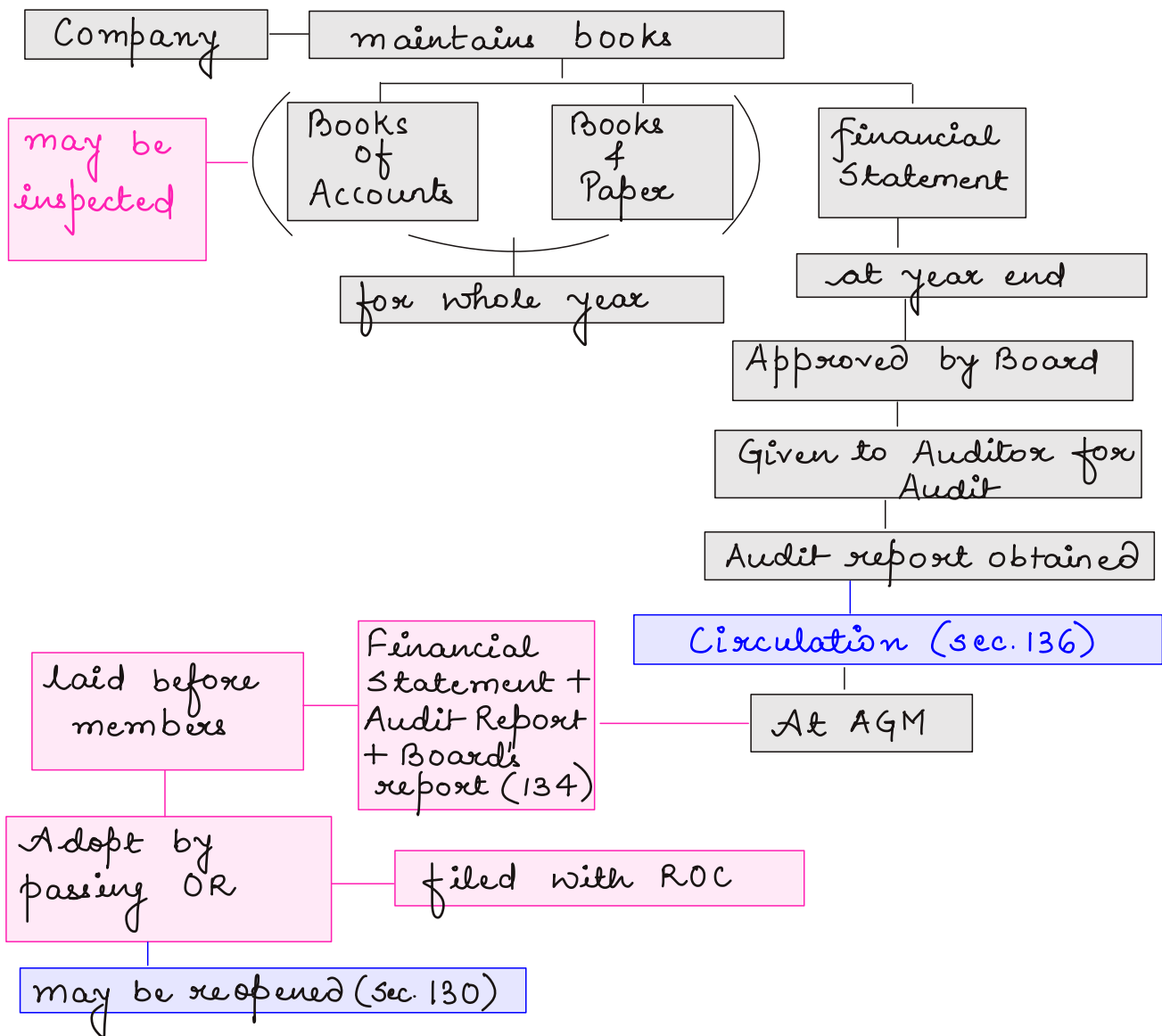

Maintenance of Books of Accounts (sec.128)

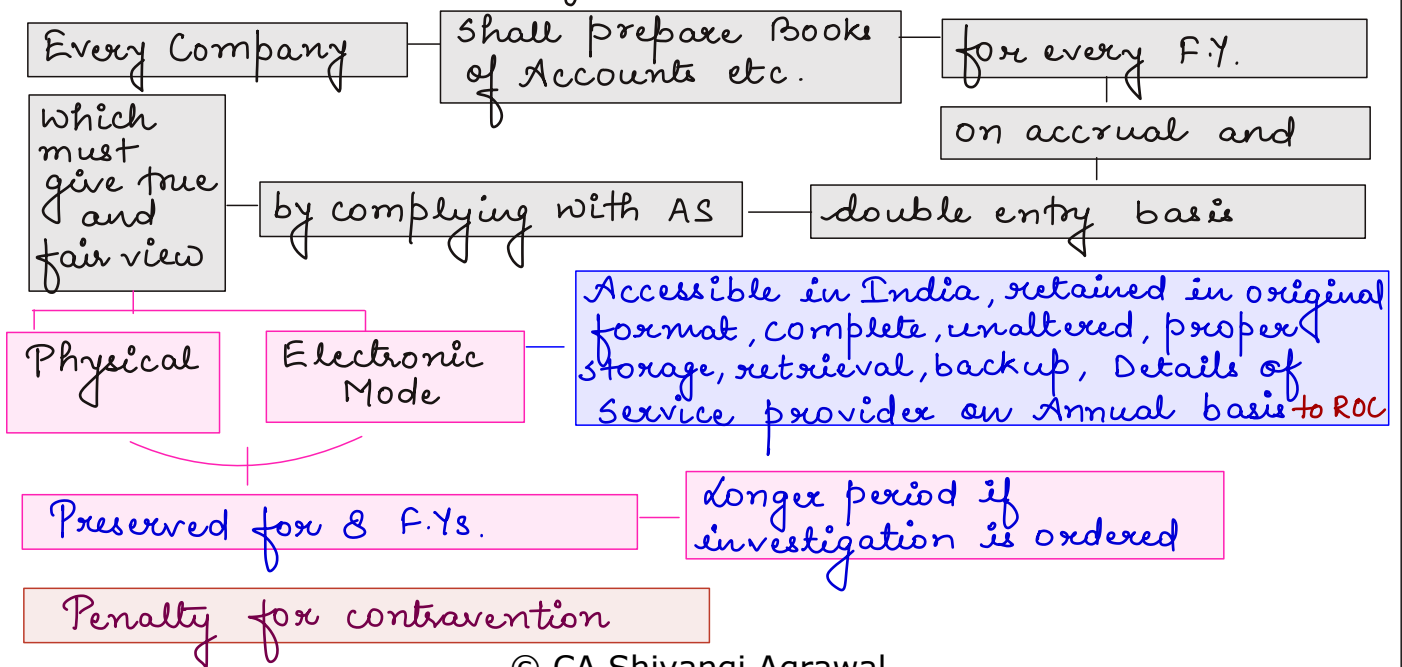

Place of Maintenance of Books of Accounts

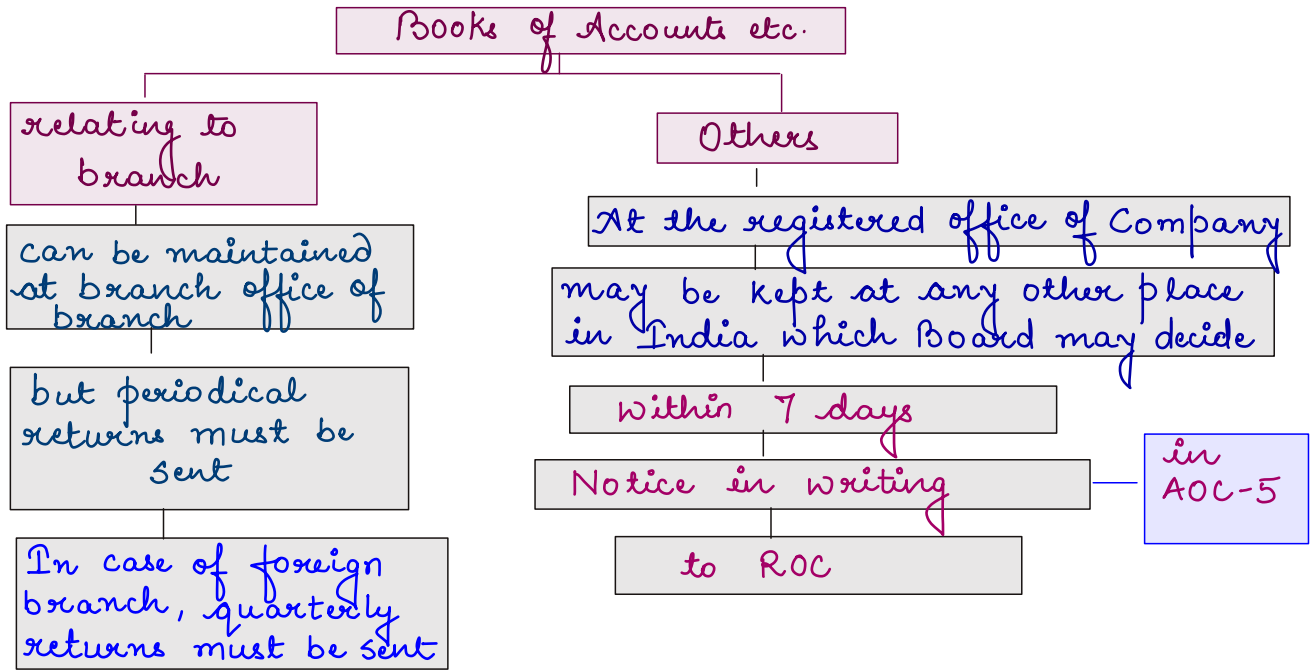

Inspection of Books of Accounts etc.

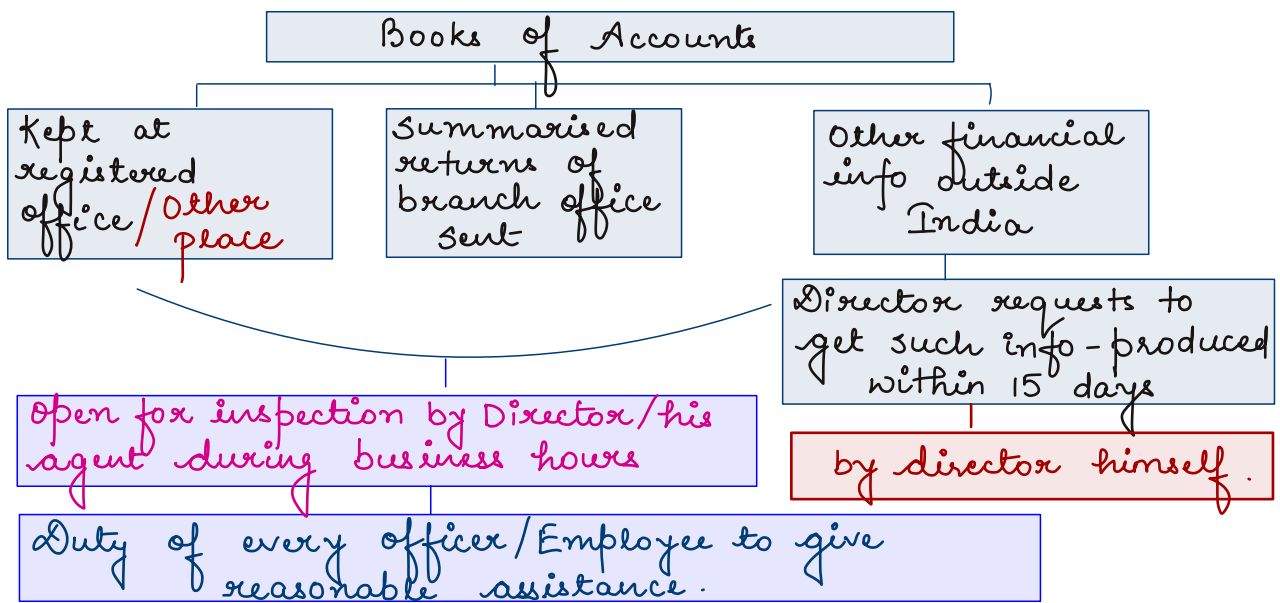

Inspection of books of accounts of subsidiary shall be made only by person authorised by board.

Financial Statements [Sec. 129]

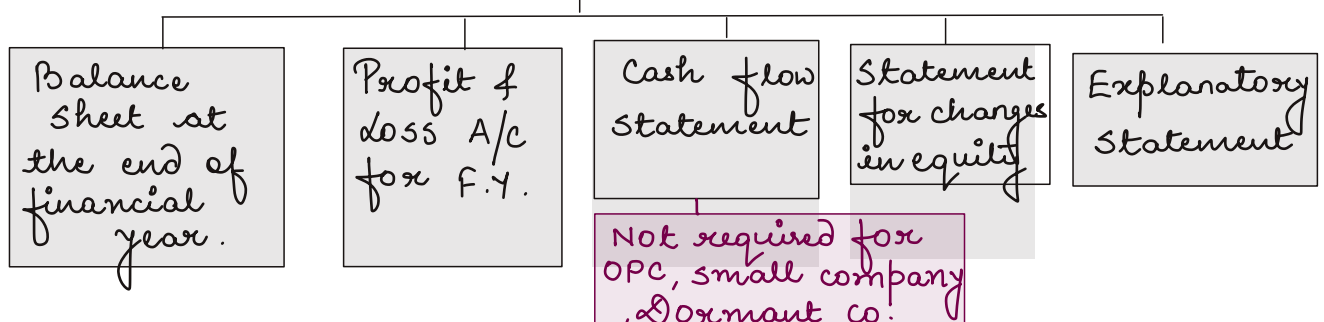

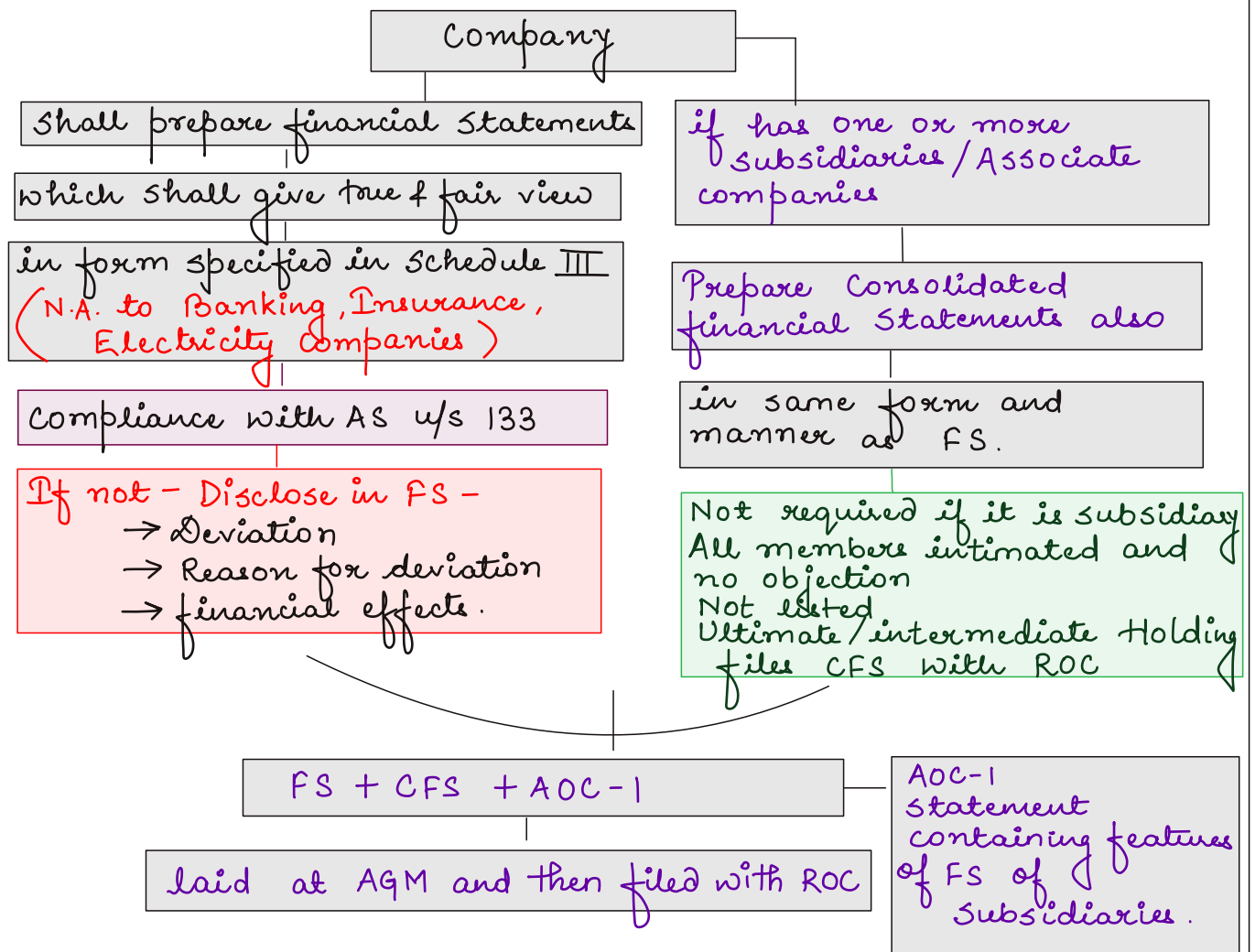

Non-compliance :-
 MD/^{finance}WTD / CFO / Person charged by Board /
 All Directors (if Absence of above)

fine and/or imprisonment
 Minimum - 50000
 Maximum - 5 lakh
 Imprisonment Upto 1 year.

Approval and Signing of financial Statements (Sec. 134)

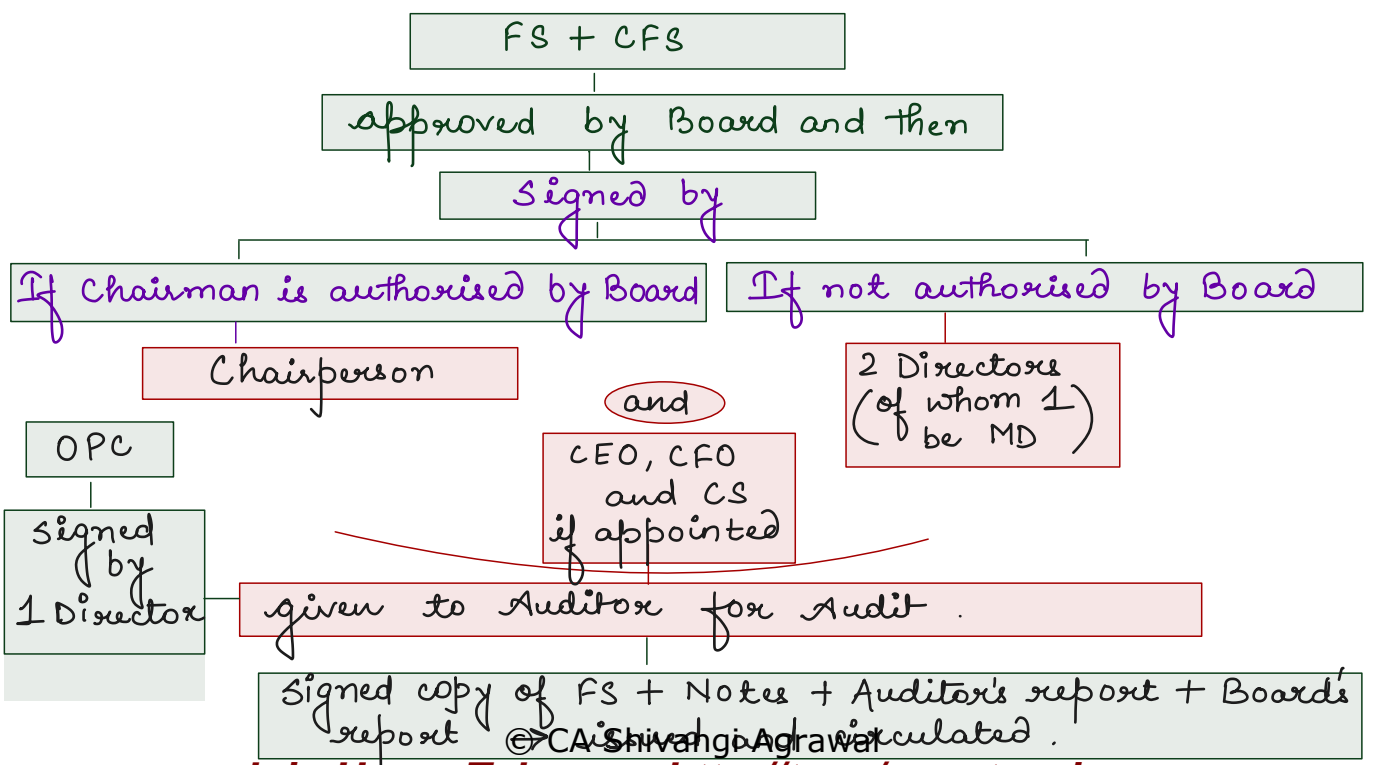

Right to get Audited Financial Statement [Sec. 136]

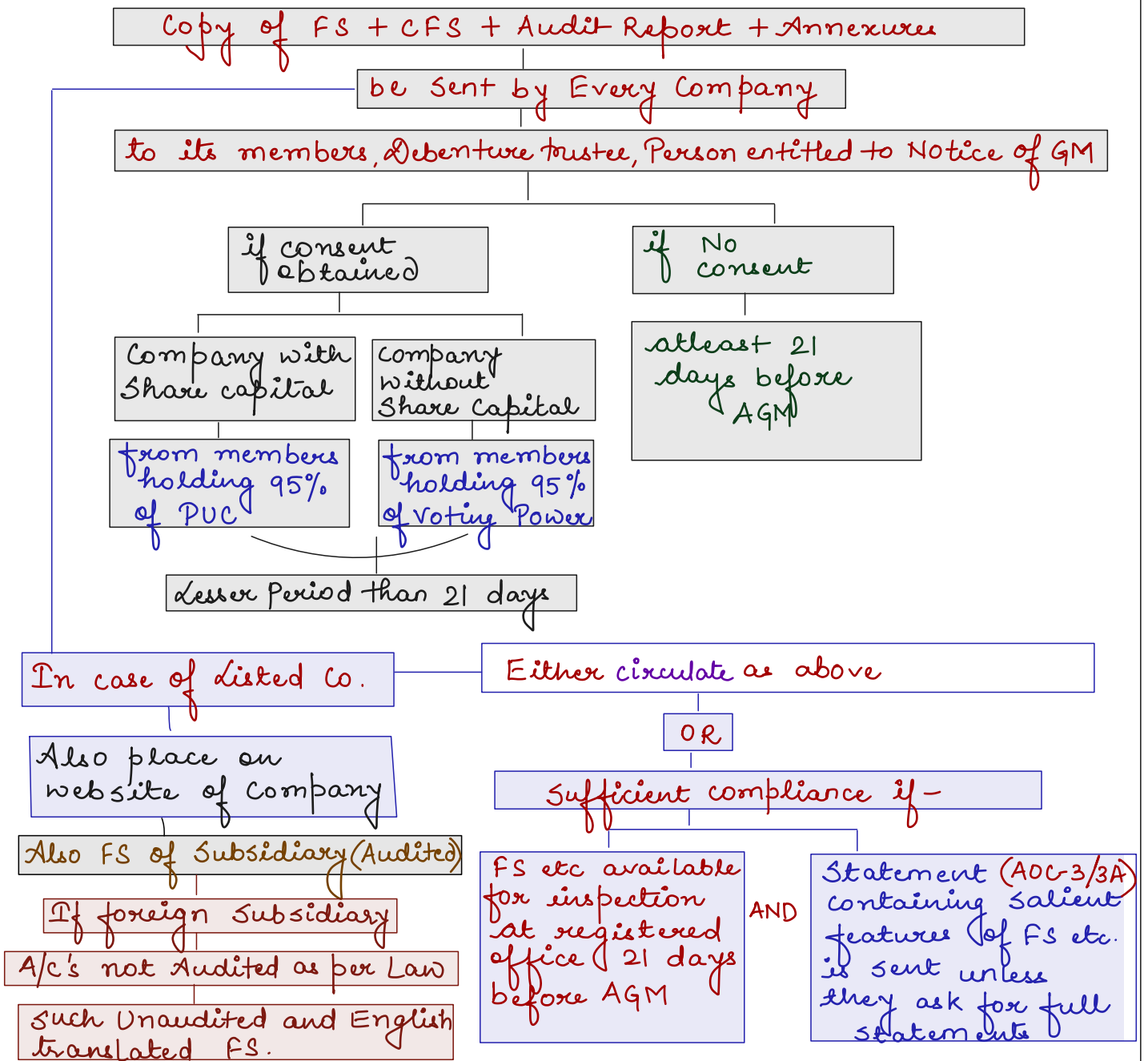

Manner of Circulation

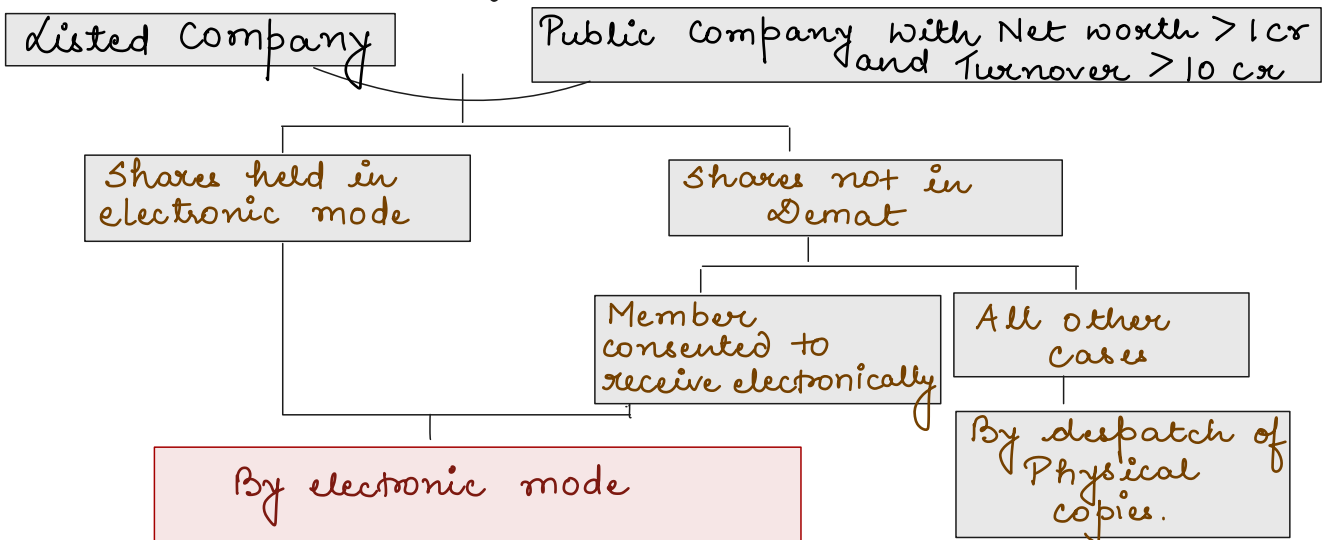

Re-opening of Accounts [Sec. 130]

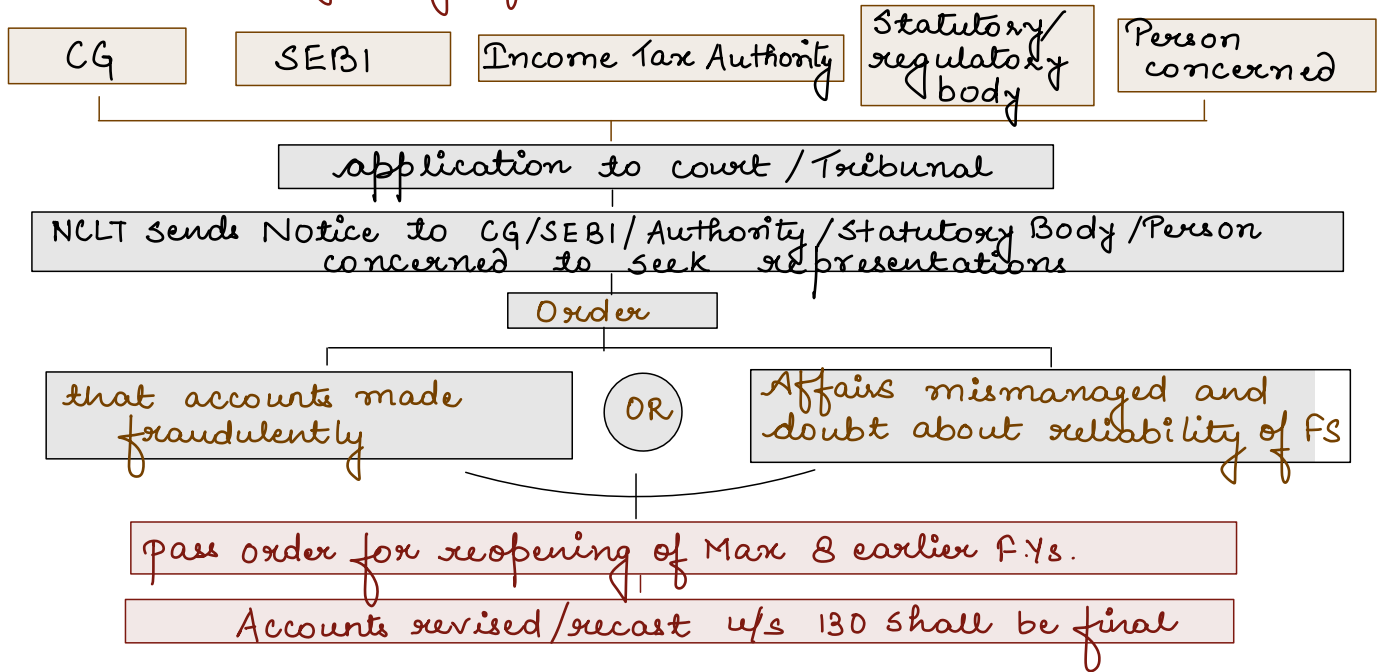

Board's Report [Sec. 134]

<p>Web Address</p> <p>No. of meetings by Board</p> <p>Director's responsibility Statement</p> <p>Details of fraud reported by CA</p> <p>Statement of declaration by Independent Director</p> <p>Nomination and Remuneration Committee</p> <p>Explanation by Board on Adverse comment by Auditor</p> <p>Particulars of loans</p> <p>Particulars of contracts with R.P</p> <p>Amount transferred to Reserves</p> <p>Dividend Proposed</p> <p>State of affairs of co.</p>	<p>Material changes after end of FY but before Board's report</p> <p>conservation of energy, technology, foreign exchange.</p> <p>Risk Management</p> <p>CSR</p> <p>Board's Performance</p> <p>Prescribed matters -</p> <p>financial summary</p> <p>KMP / Directors</p> <p>Change in nature of business</p> <p>Change in subsidiary/Associate/Joint Venture.</p> <p>Deposits</p> <p>court / Tribunal's order</p> <p>cost records</p> <p>Sexual Harassment Act compliance</p>
--	--

Abridged Report for OPC & Small Company

Web address

No. of Board meetings

Director's responsibility Statement

fraud reported by Auditor & comment on it.

Company's affair, financial summary

Directors - Appointed/resigned

Changes in Nature of business

Court order

contract with Related Parties

Voluntary Revision of FS/Boards Report [Sec. 131]

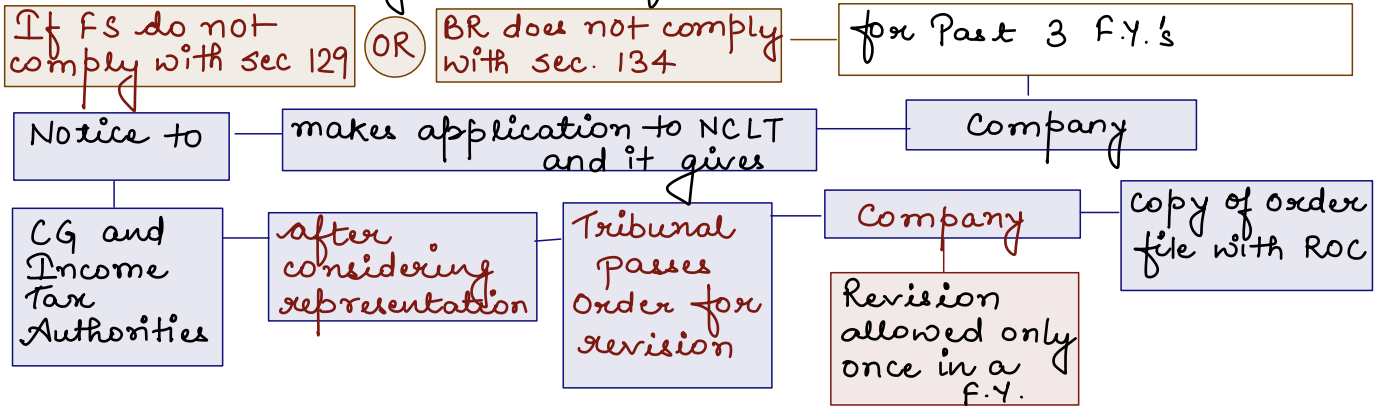

filing of Documents with Registrar [Sec. 137]

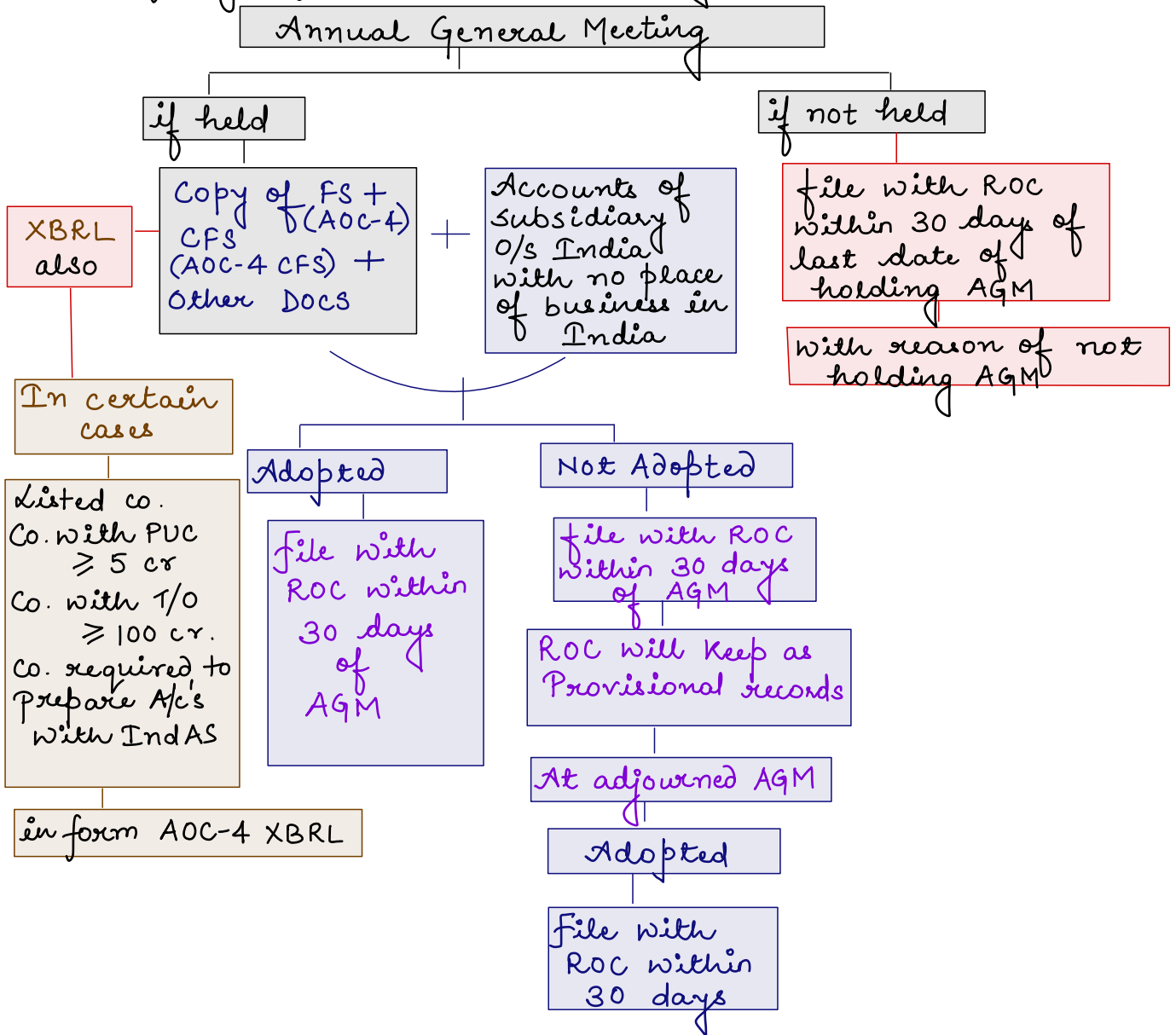

OPC shall file FS with other docs within 180 days from closure of F.Y.

If foreign subsidiary not required to get FS audited according to laws of that country, Holding co. can file unaudited CA statement with such declaration.

National Financial Reporting Authority [Sec. 132]

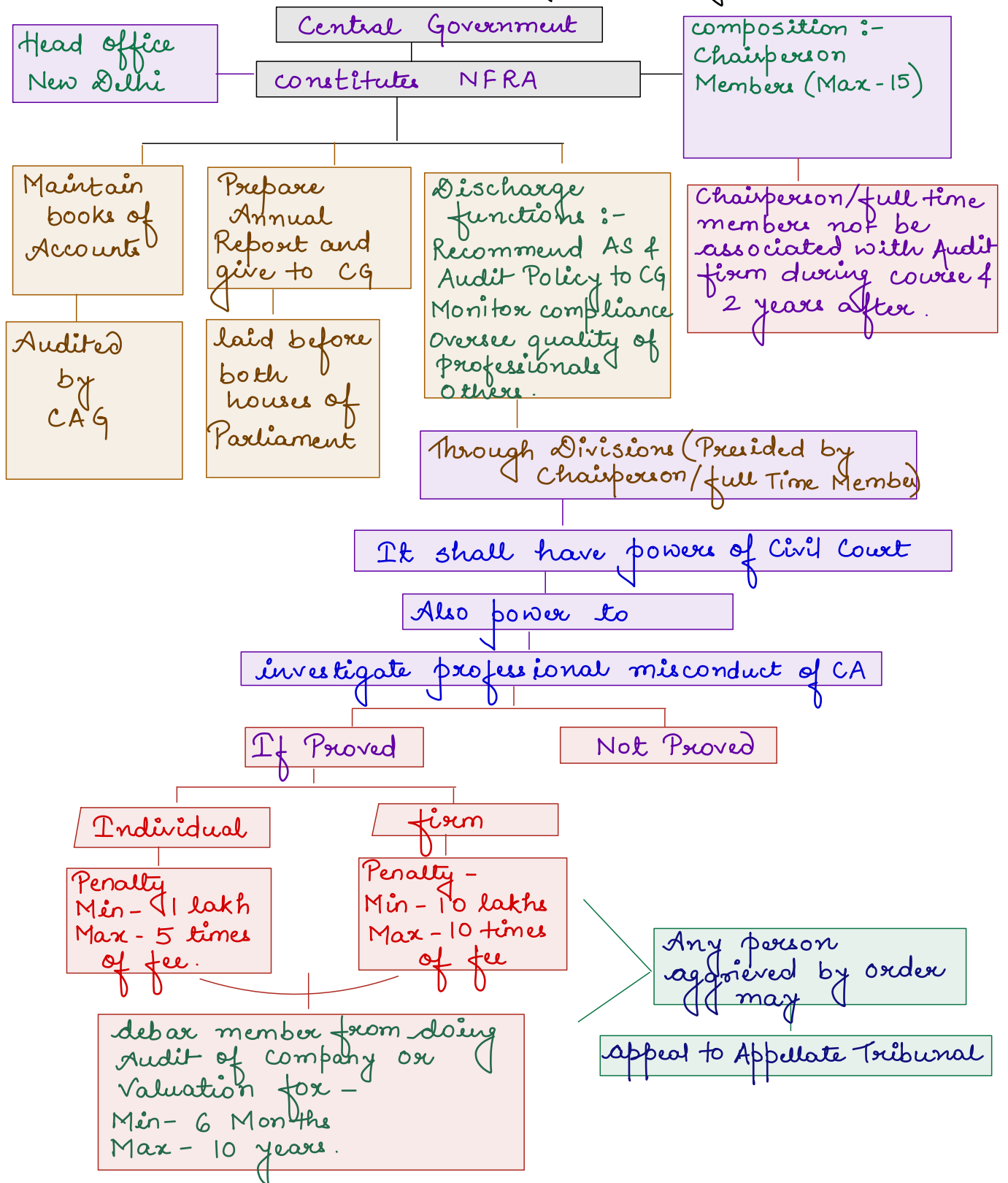

There shall be an executive body to discharge functions when NFRA initiates investigation, no body to initiate or continue proceedings. CG may appoint employees as required.

Corporate Social Responsibility [Sec. 135]

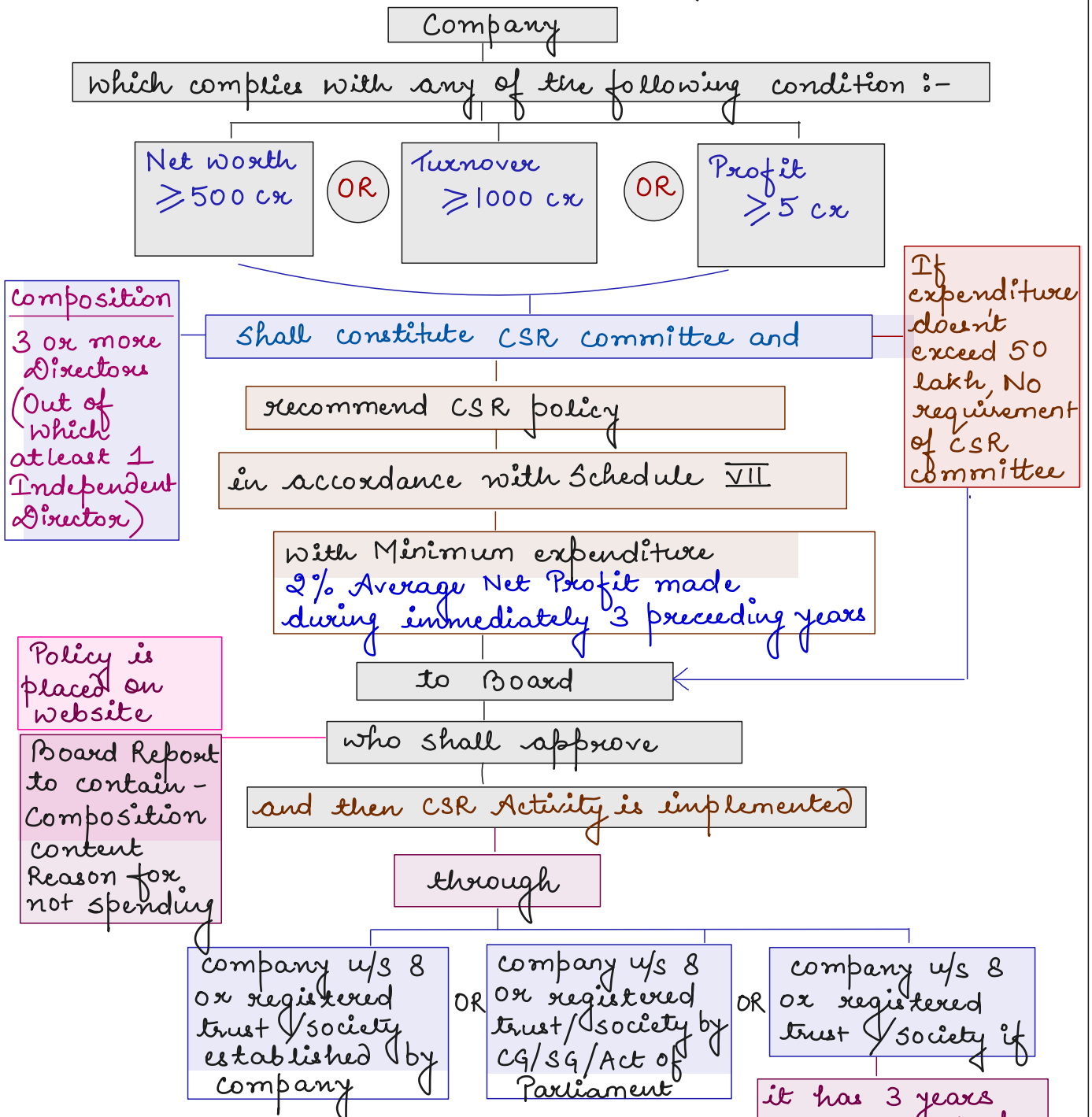

What shall not be considered as CSR?

- ⊙ Activities undertaken outside India.
- ⊙ which benefits only employees and their families.
- ⊙ Contribution to Political Party.
- ⊙ Activity in normal course of business

Internal Audit [Sec. 138] read with Rule 13

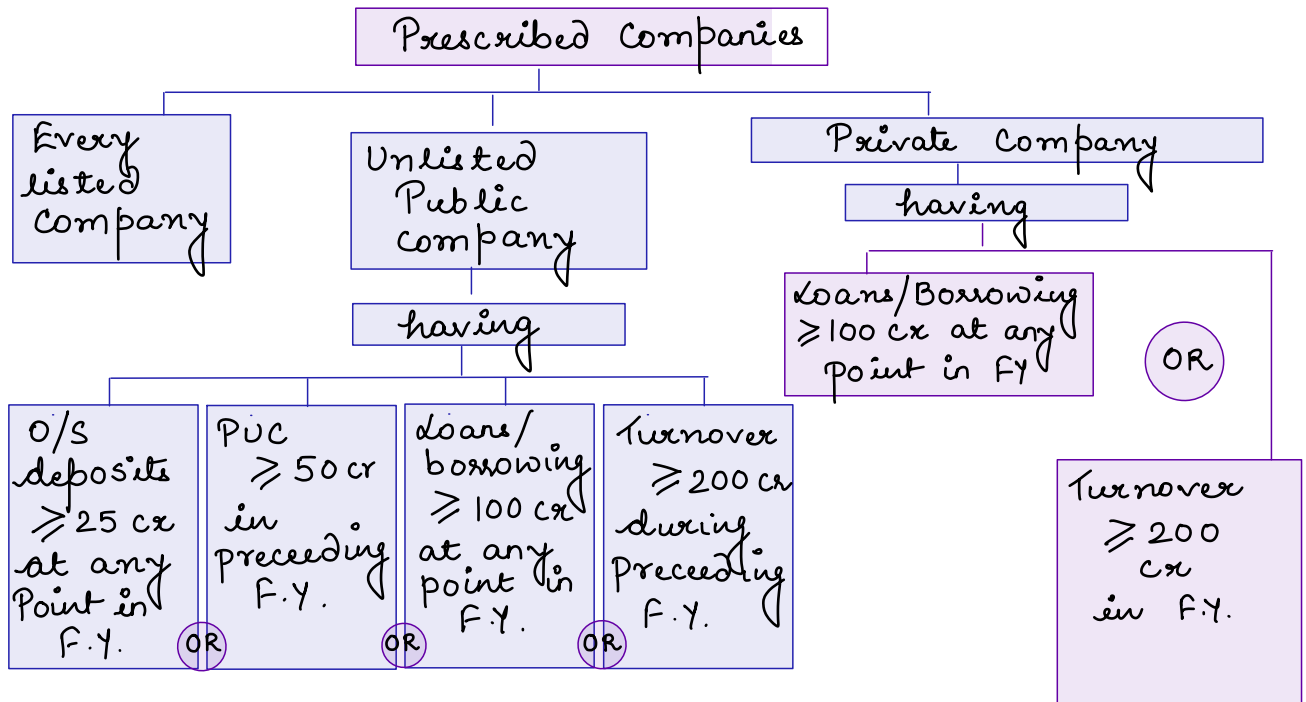

shall appoint **Internal Auditor**

who may be

Chartered Accountant
Cost Accountant
Other Professional as decided by Board

→ may be an employee also
→ Individual / Partnership.

to discharge functions within scope as determined by Audit Committee or Board.

Audit and Auditors

Chapter X (containing Sec. 139 to 148)

Audit is mandatory for every company for each F.Y.

Company incorporated

Appoint Auditors according to Sec. 139

can be Individual only if he is a CA in practice

or Firm/LLP majority of Partners CA - Only CA can sign

Provided they are qualified u/s 141 and not rendering services u/s 144

after obtaining from Auditor

Consent

Certificate

that not disqualified. Appointment as per term. within limit correct list of proceedings satisfaction of criteria u/s 141

Appoint Auditors in prescribed manner

Inform Auditors

file Notice of Appointment

with ROC within 15 days of meeting in which appointed

with NFRA within 15 days of appointment in NFRA-1

for body corporate which does not file ADT-1

can resign/be removed according to section 140

be conferred with certain rights and duties according to sec. 143

Appointment of Auditors (Sec.139)

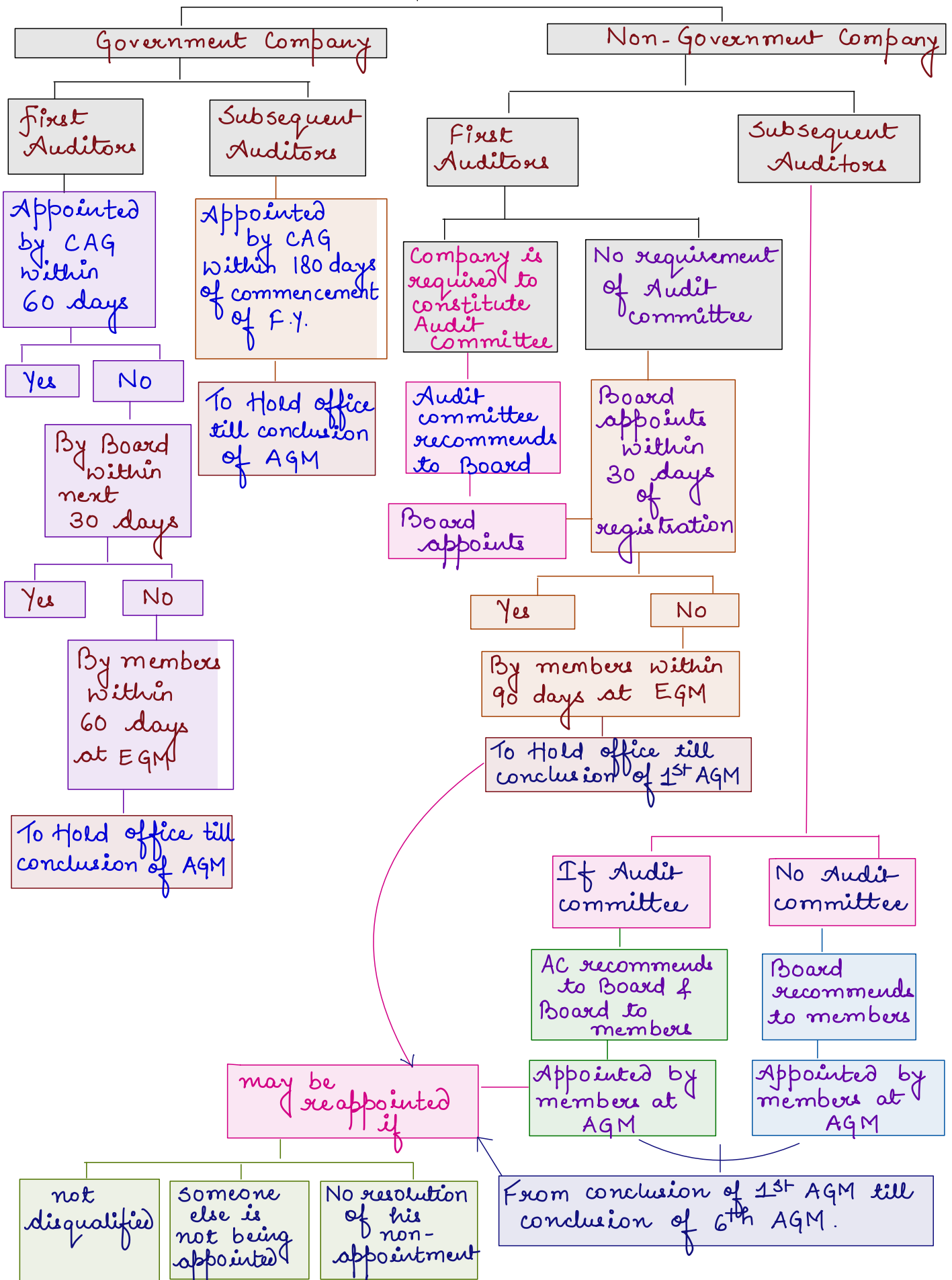

Where at any AGM, No Auditor is appointed/re-appointed existing Auditor shall continue.

Rotation of Auditor (Sec. 139(2))

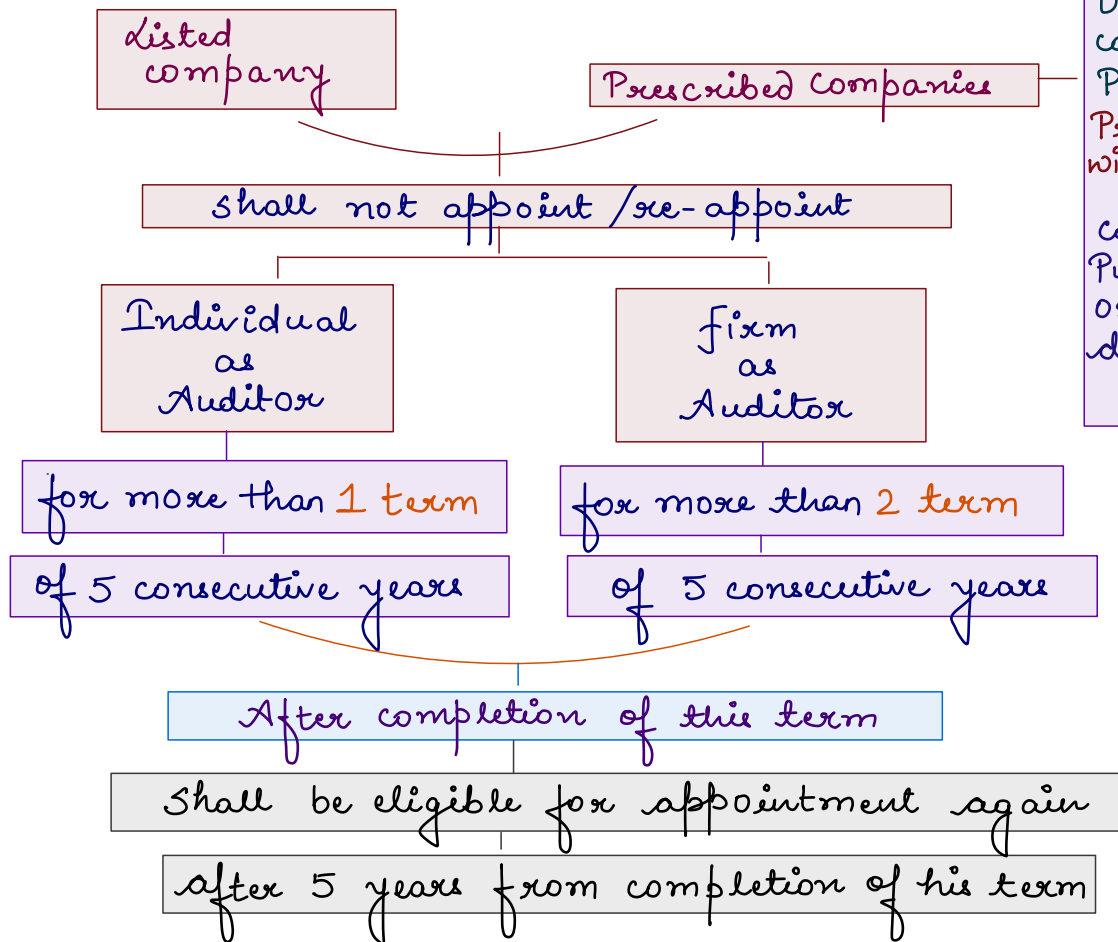

Rule 5
 Unlisted Public company with PUC ≥ 10 cr.
 Private company with PUC ≥ 50 cr
 OR
 Company with Public borrowing or public deposits ≥ 50 cr.

If Audit firm has common Partner whose Term expired, such firm can also not be appointed for 5 years.

Company before commencement - to comply within 1st AGM after 3 years from date of commencement

Members may resolve to provide for rotation of Auditor within firm.

Auditor can still resign or be removed within this term.

Manner of Rotation

Audit committee wherever appointed

shall recommend name of Auditor to Board of it

shall propose the same in AGM

Period as Auditor before commencement of Act shall be taken into account when computing 5/10 years

Partner in charge retires and joins another firm, such firm shall also be ineligible.

Consecutive years shall mean all preceding financial years until a break of 5 years or more.

Casual Vacancy

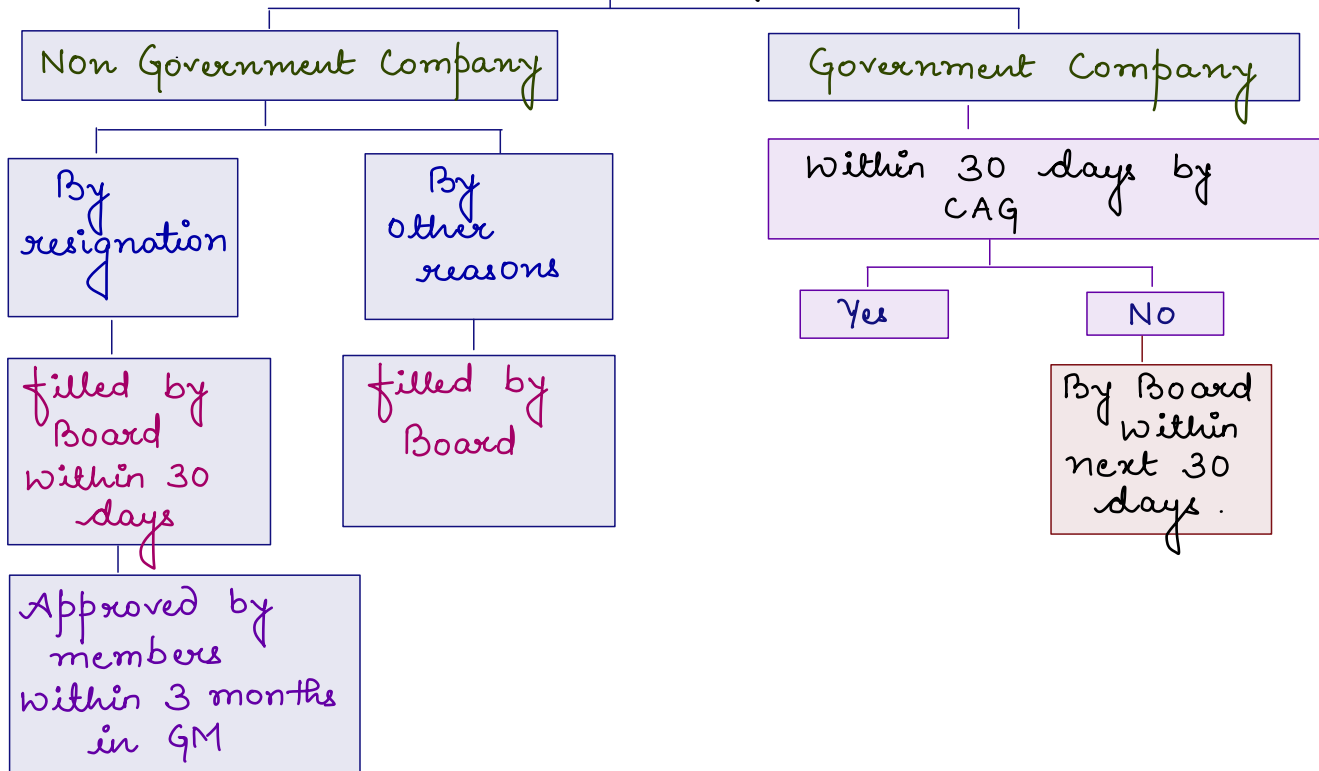

Disqualifications of Auditors [Sec. 141(3)]



Person (who / his relative / his partner) -



If any disqualification incurs, vacation of office - amounts to Casual Vacancy

Removal of Auditor before Term [Sec. 140]

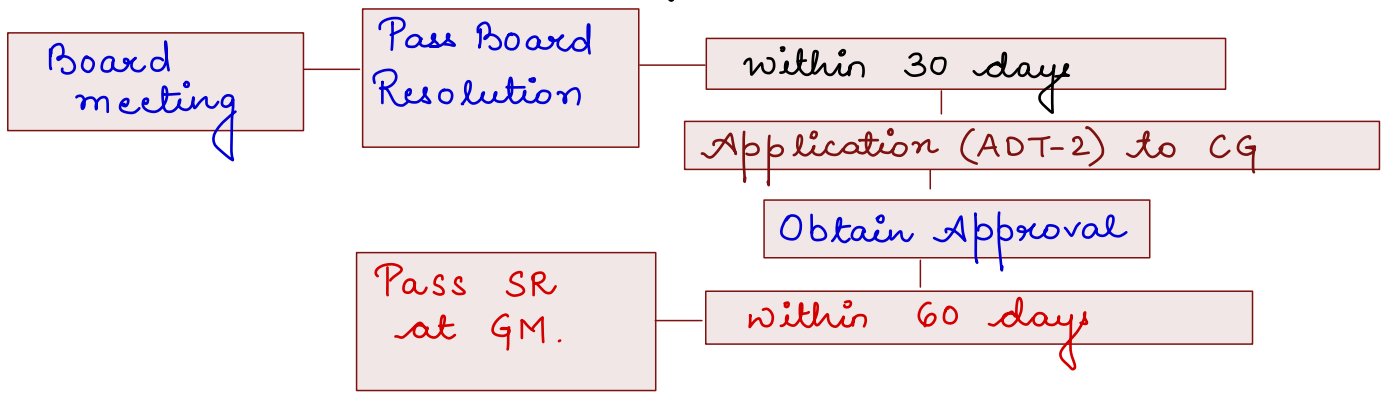

Auditor to be given reasonable opportunity of being heard

Resignation by Auditor

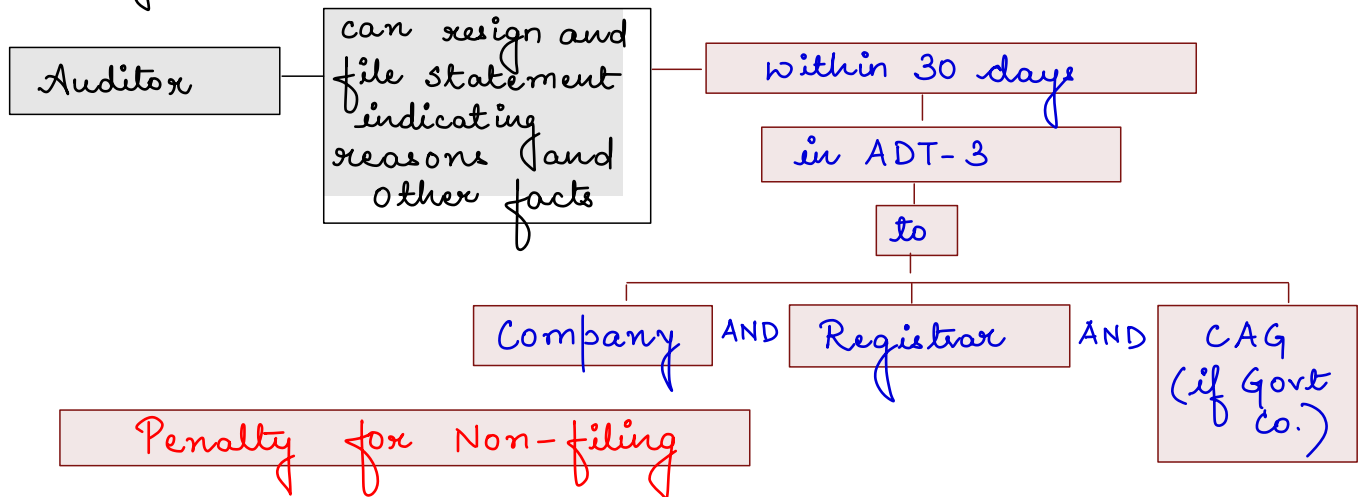

Special Notice for not reappointing retiring Auditor

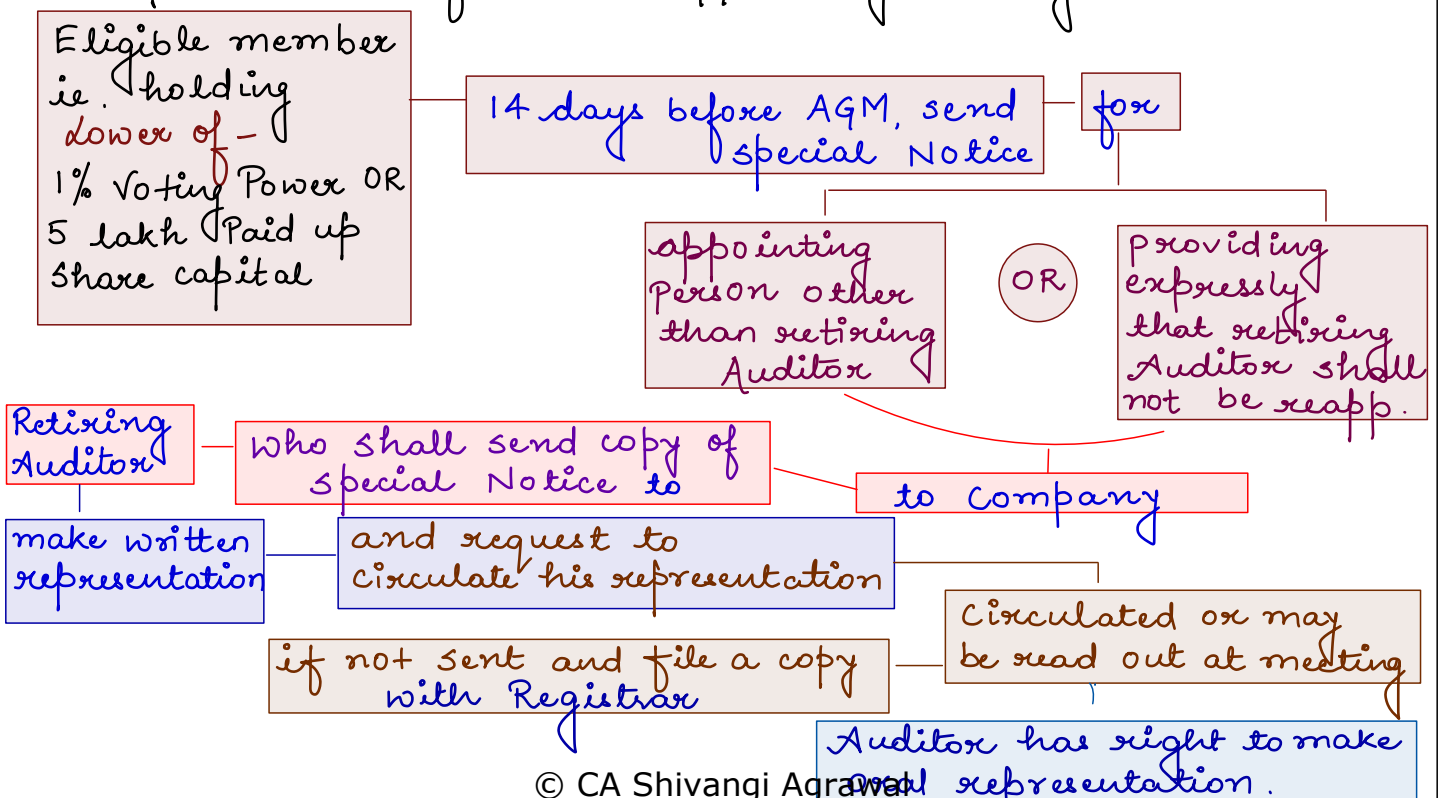

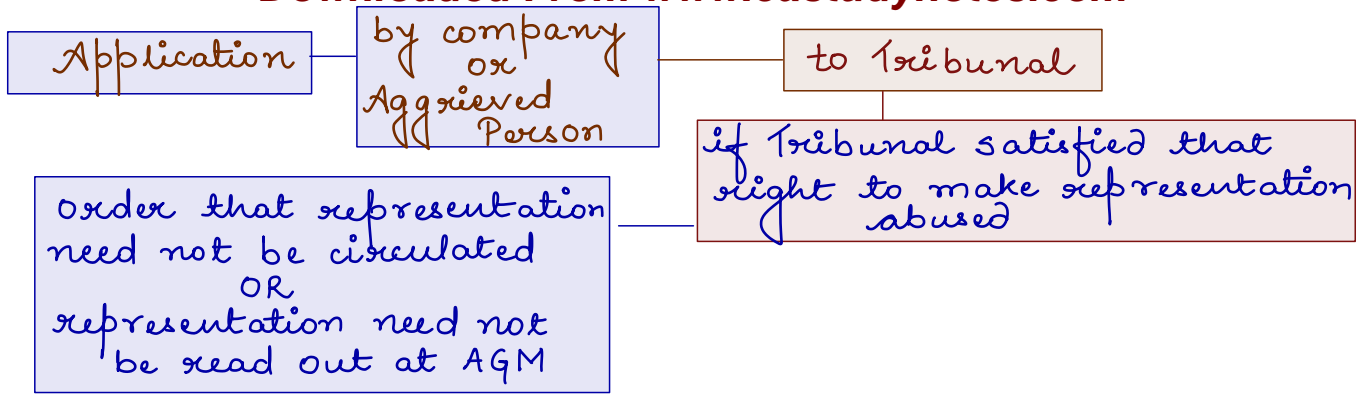

Power of Tribunal to change Auditor

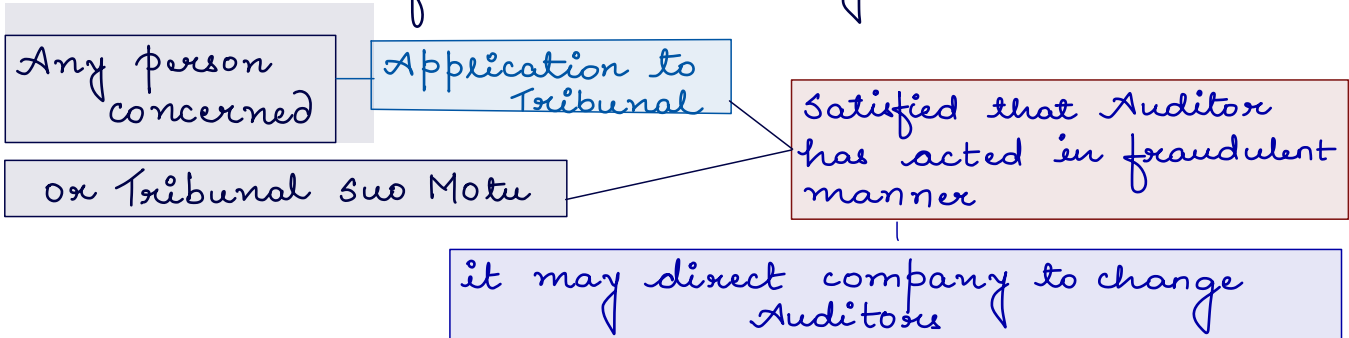

If Application is made by CG, within 15 days, make order that he shall not function as Auditor & CG may appoint another.

Such Auditor shall not be eligible to be appointed as Auditor for 5 years and also liable for action u/s 447.

Powers and Duties of Auditor [Sec. 143]

Rights

- to access books of accounts
- to receive Notice
- to make inquiries
- to receive remuneration
- Right of lien.

Duties

- Duty to make inquiries
- Duty to make report
- Duty to follow Auditing Standards
- to exercise reasonable skill and care.

Audit of Government Companies

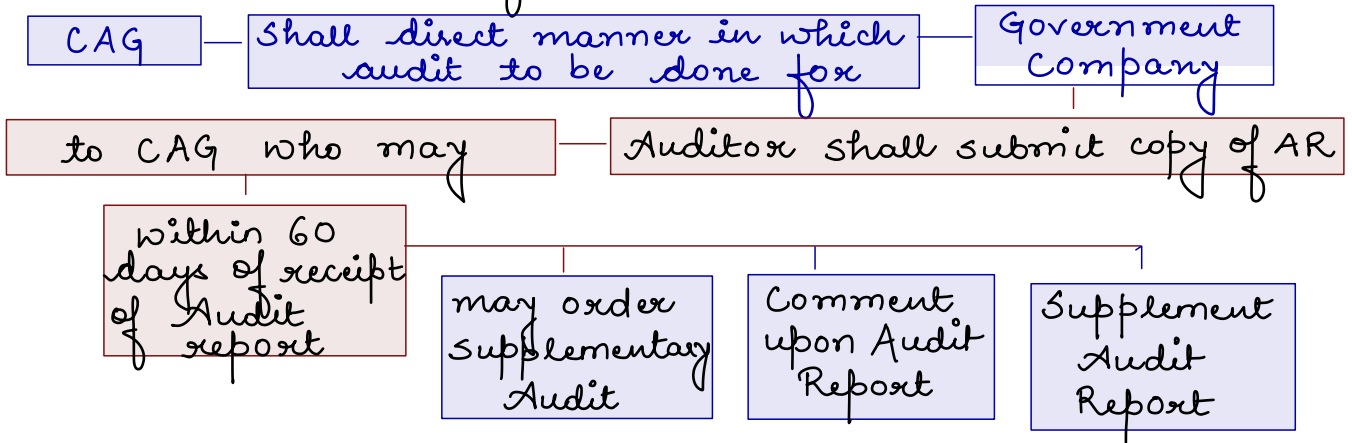

Branch Audit

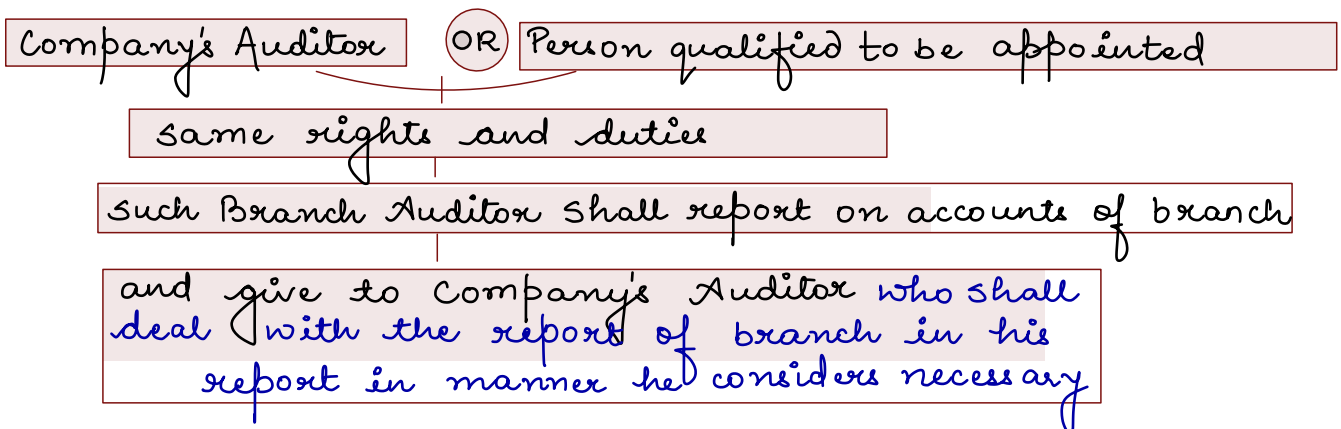

Reporting of fraud by Auditor

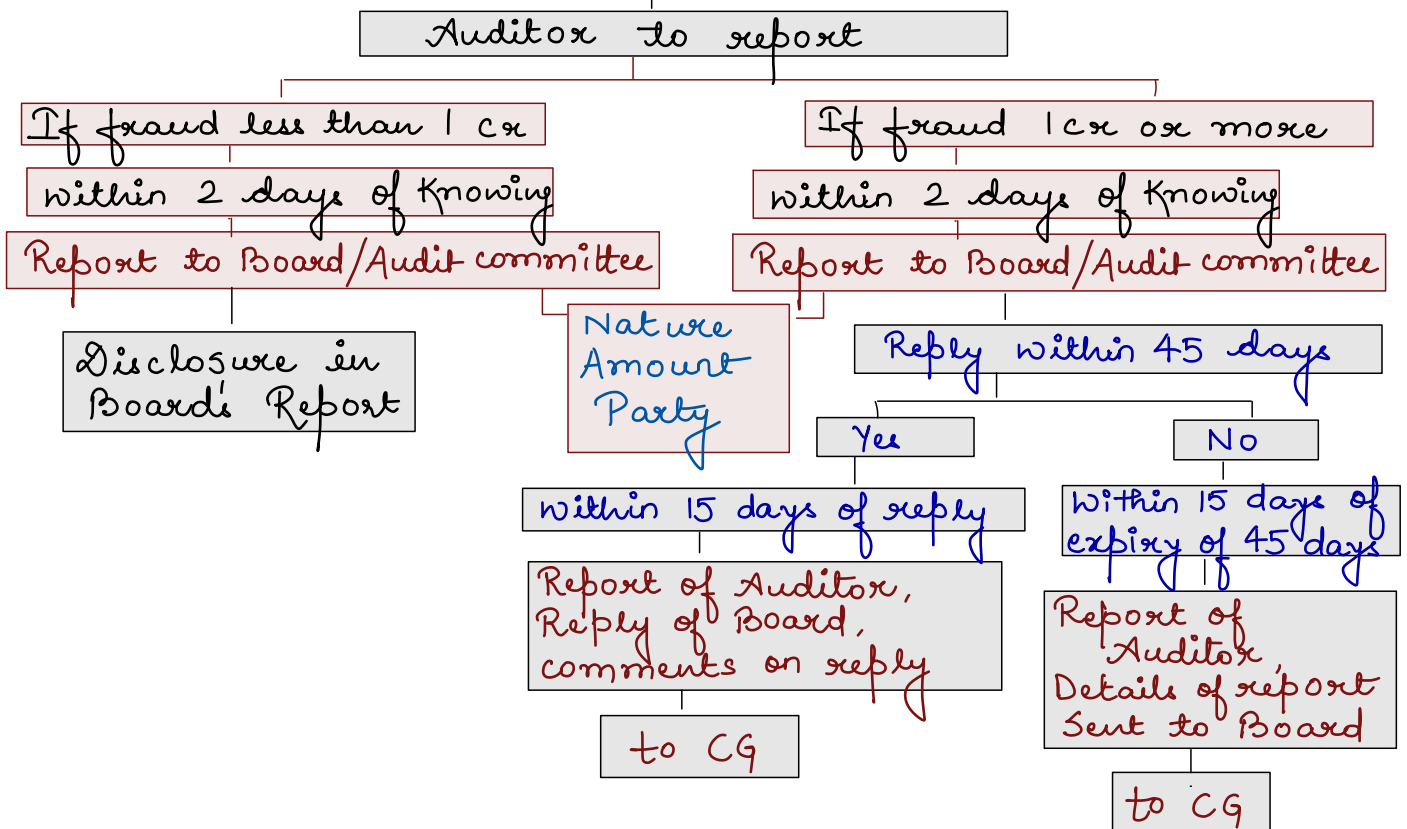

Auditor not to render certain services (Sec. 144)

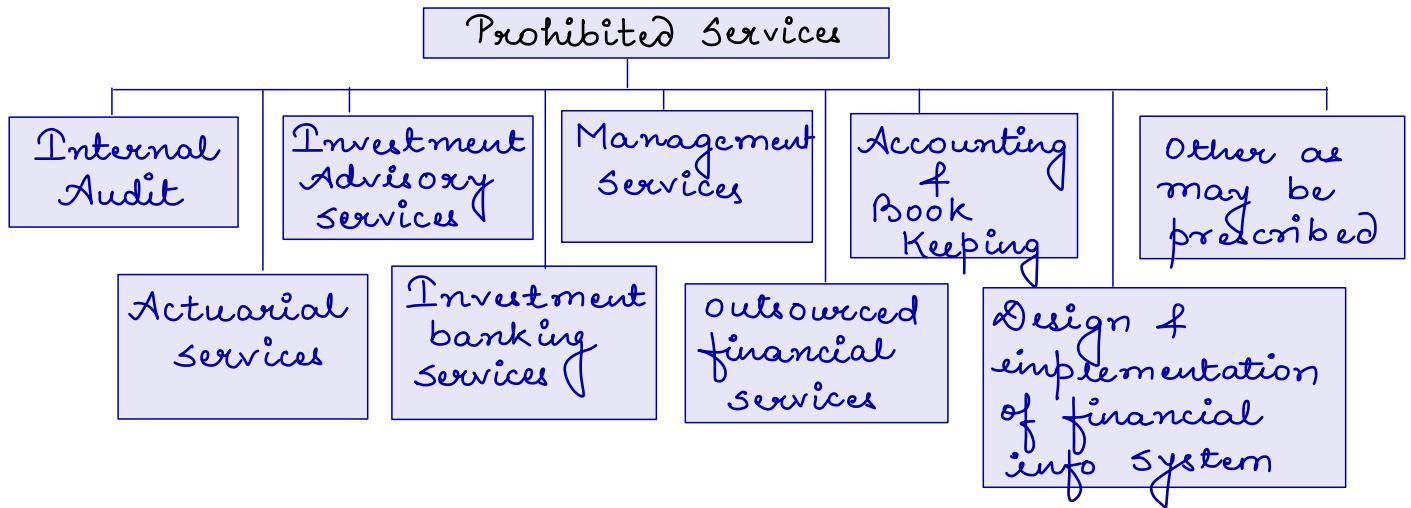

Cost Audit [Sec. 148]

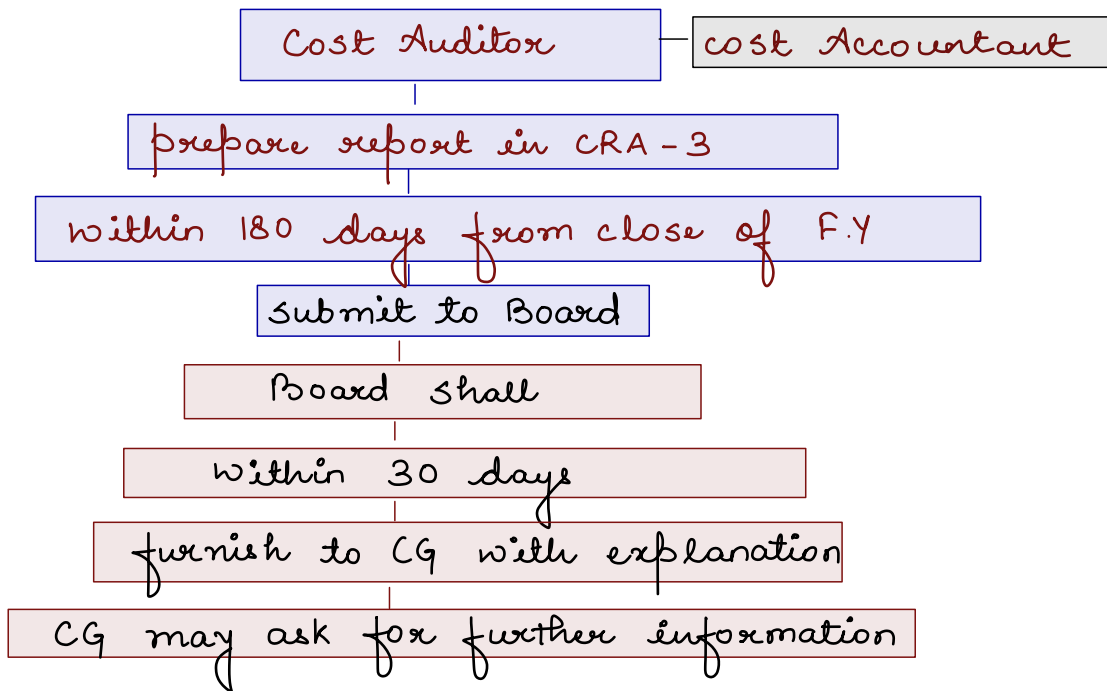

Negotiable Instruments Act .

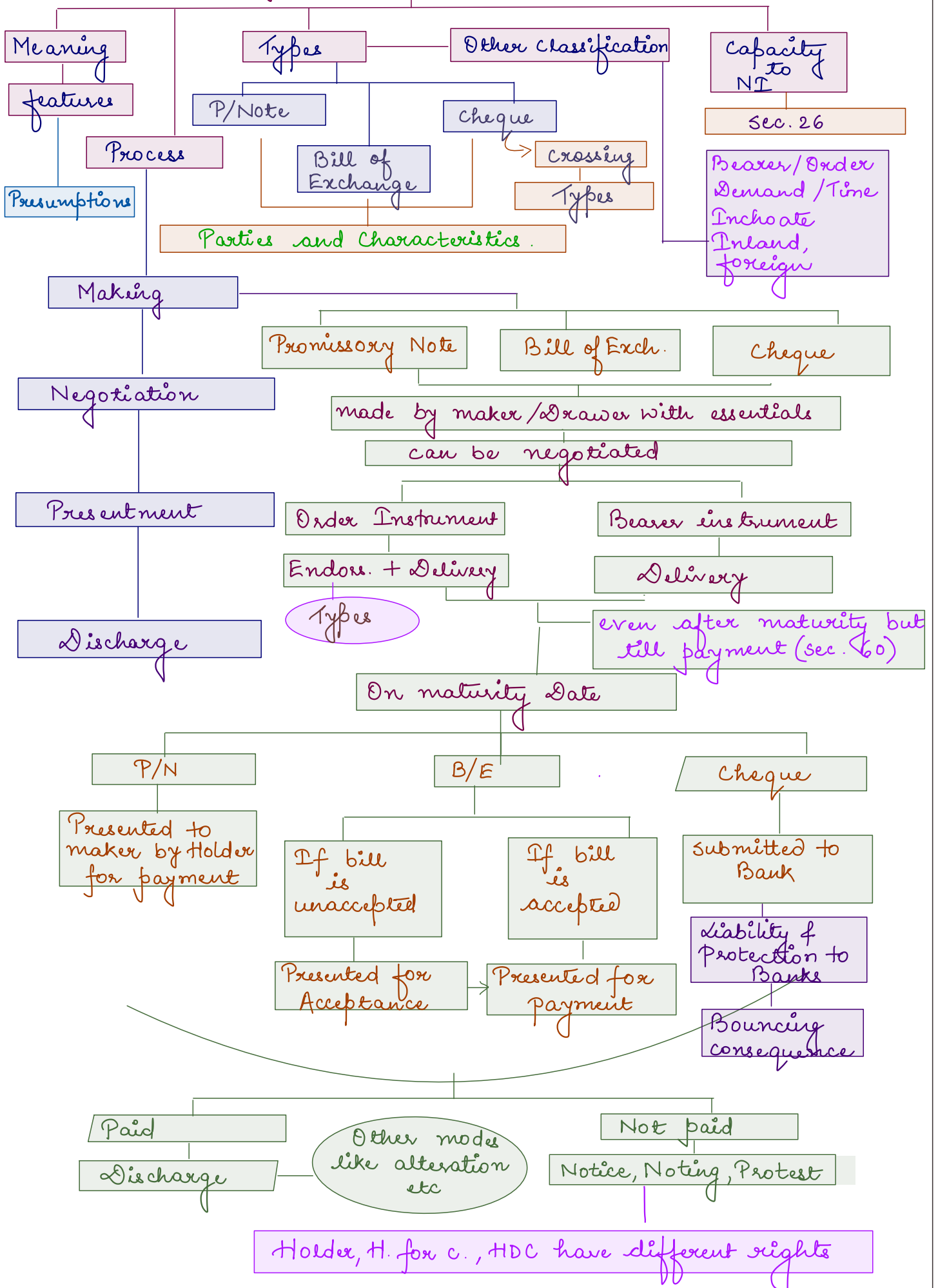

Features of Negotiable Instruments

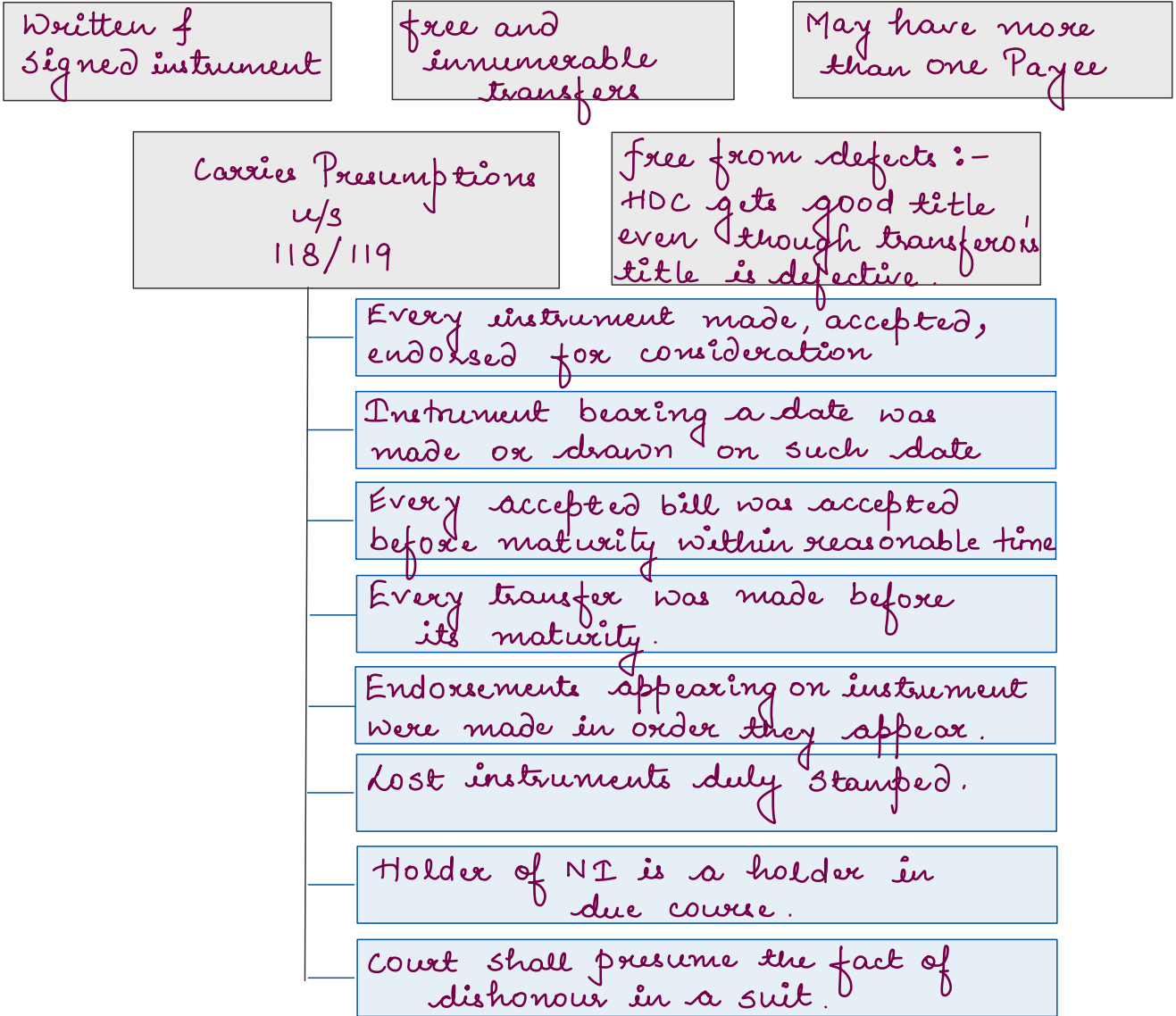

Promissory Note [Sec. 4]

Instrument in writing containing unconditional undertaking signed by maker to pay certain sum of money only to or to order or to bearer of instrument.

Parties to Promissory Note

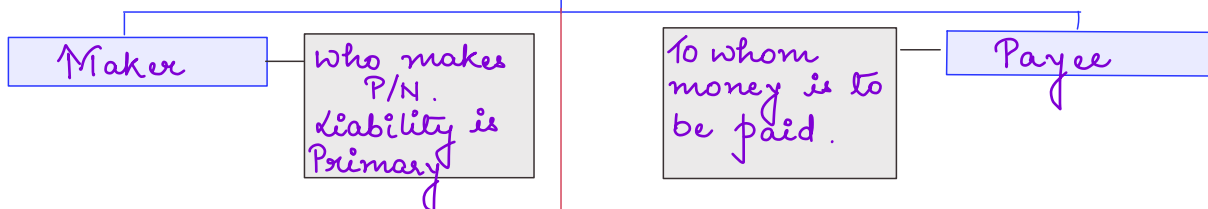

Essentials of Promissory Note.

In writing	Express Promise to pay	Definite & unconditional	Signed by maker
certain sum	Money only	certain Payee	Stamped

Types of Instruments

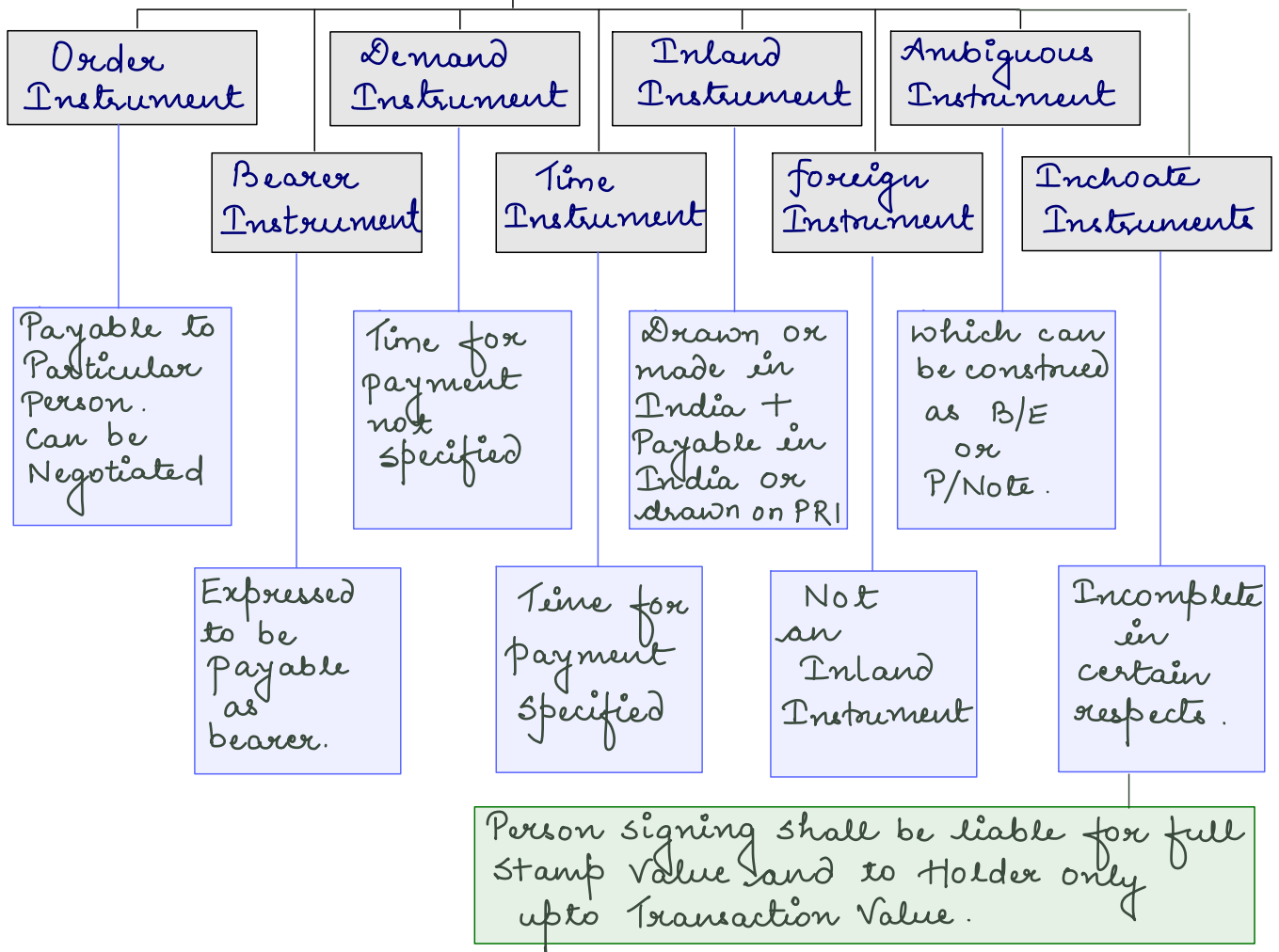

Maturity of Negotiable Instruments

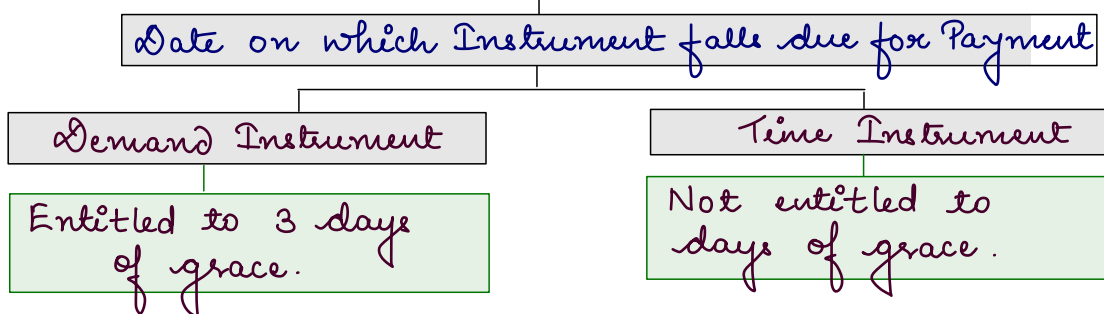

Rules of Maturity :-

- If No corresponding day in a Month, period to terminate on last day of such Month.
- If matures on Public Holiday, preceeding business day.
- If matures on Emergency Holiday, deemed to be due on succeeding business day.

Cheque [Section 6]

Bill of Exchange drawn on specified banker payable on Demand.
 Includes Electronic and Truncated Cheque.

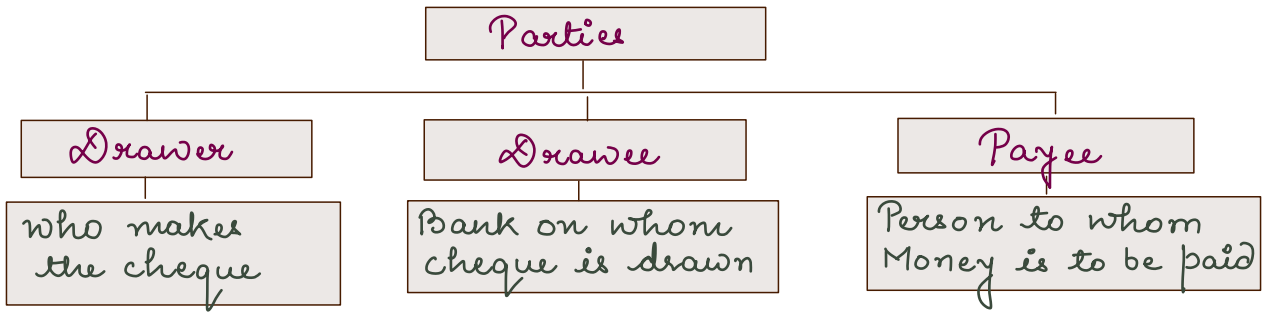

Essentials of Cheque

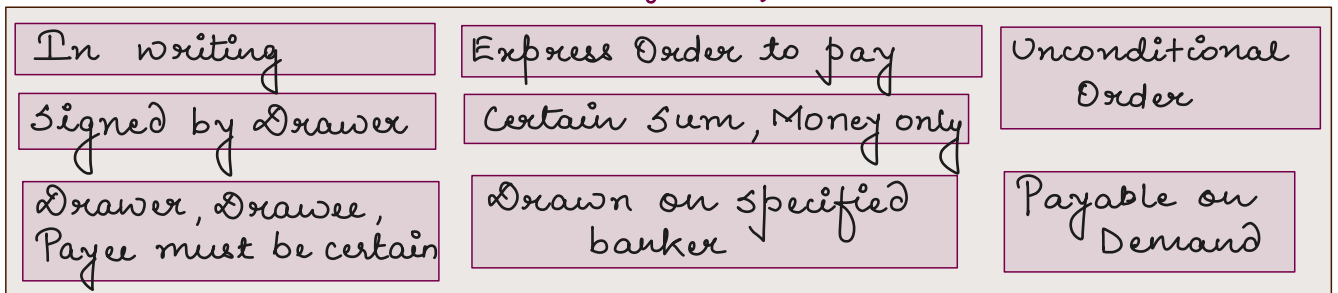

A cheque may be Order or Bearer cheque and

It may be **CROSSED**

Crossing means giving direction to paying banker that Payment can be collected only through Banker.

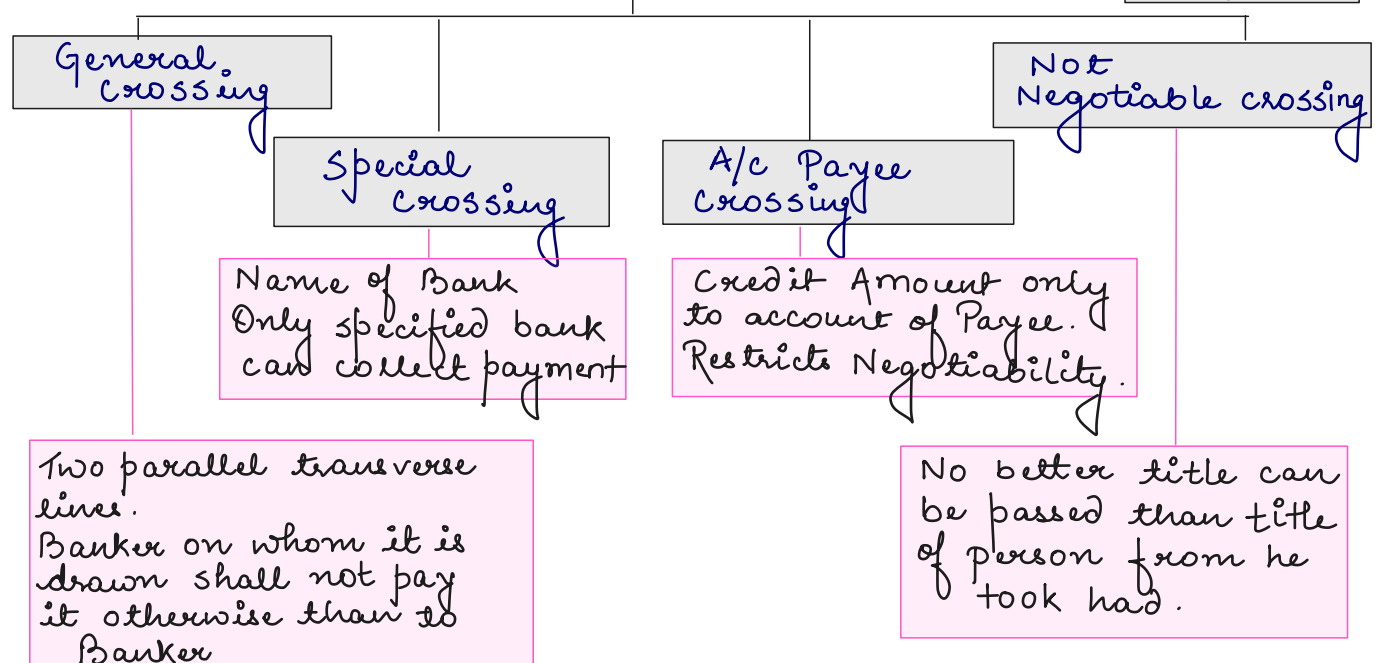
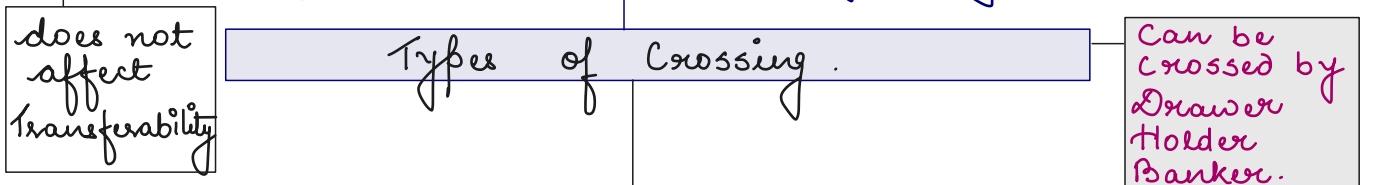

Protection to Paying Banker

Banker making Payment of cheque.

No liability of Paying Banker if :-

In case of Order Cheque

If payment made in due course to Indorsee

In case of bearer Cheque

If payment made in due course to Bearer

In case of Generally crossed Cheque

If payment made in due course to a Banker

In case of Specially crossed cheque.

If payment made in due course to specified banker

If Banker pays a cheque crossed generally otherwise than to Banker shall be liable to true owner of cheque

Payment in due course (sec.10)

- Apparent Tenor
- Good faith
- Without Negligence
- In possession of instrument
- In money only.

Protection to Collecting Banker

No liability of banker receiving payment if-

Banker received payment of crossed cheque collected on behalf of customer in good faith without Negligence.

Assignment :- (Different from Negotiation)

A transfer by assignment takes place when Holder of an instrument transfers to another to confer right to receive payment of instrument. (Transferee's Title = Transferor's title)

Bill of Exchange [Sec. 5]

Instrument in writing containing unconditional order signed by maker directing a person to pay certain money to or to order or to bearer of instrument.

Parties to Bill of Exchange

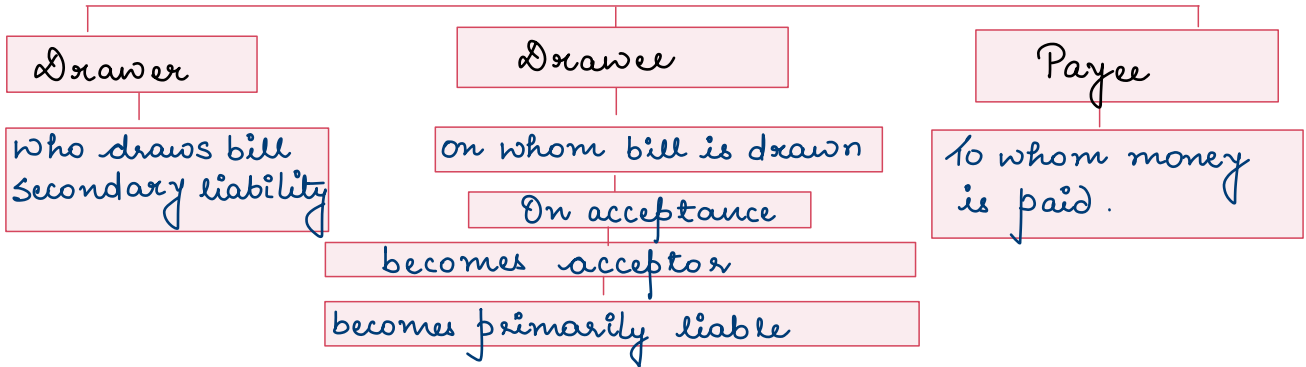

Essentials of Bill of Exchange

In writing	Express order to pay	Definite & unconditional	Signed by drawer
certain sum	Money only	Certain Payee, Drawer, drawee	Stamped

Acceptance of Bill

When Drawee signs the Bill & Delivers it to Holder

He becomes acceptor & liable

Acceptance must be without Qualification

If Qualified then-

If Holder agrees

All previous parties not consenting to it are discharged

If Holder doesn't agree

Bill dishonoured due to Non-Acceptance.

Bills in sets :- Bill drawn in parts and numbered.

Capacity to incur liability [Section 26]

Minor not liable

Other Parties will be liable

Minor can sue Adults but minor can't be sued.

Negotiation :-

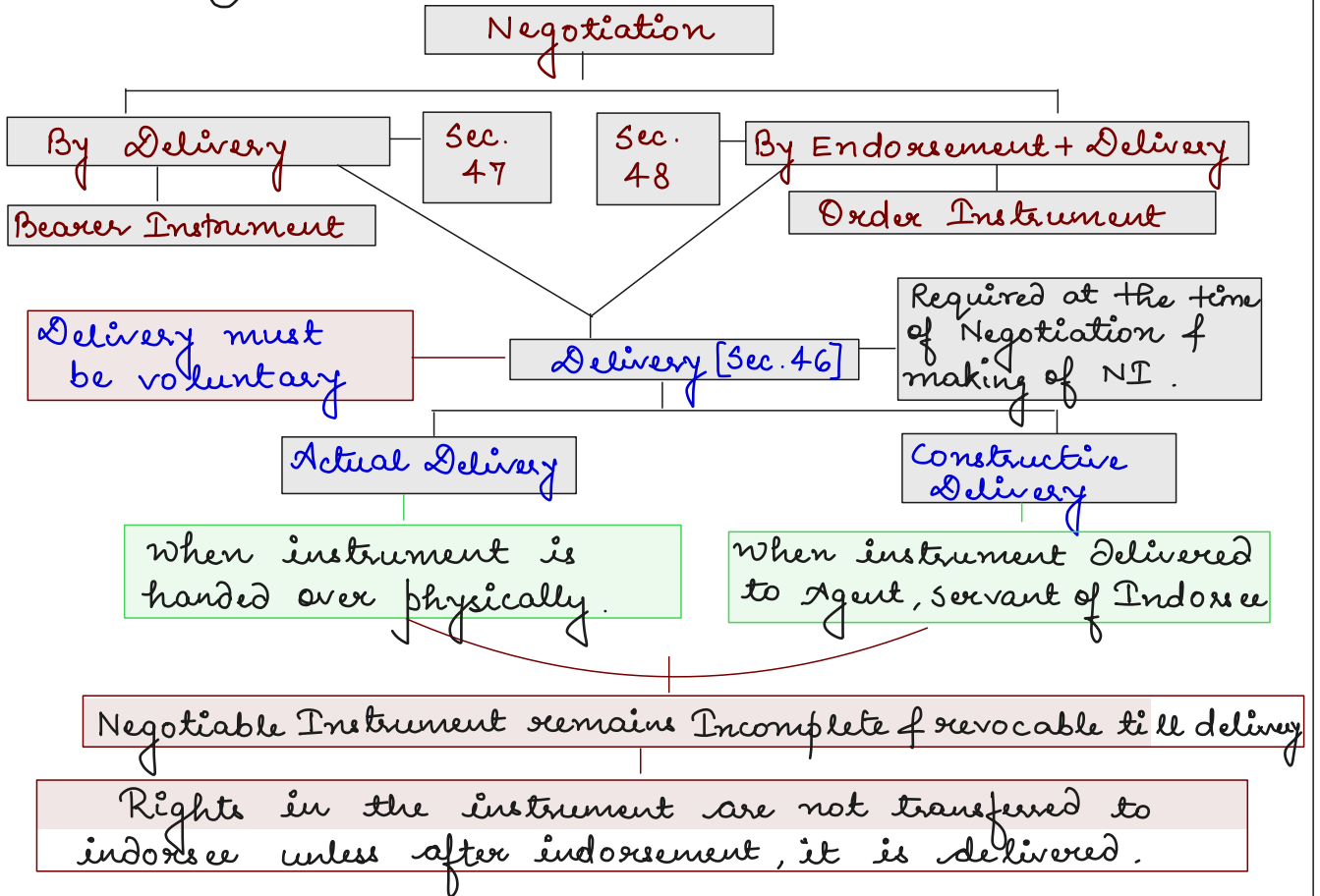

Rights in the instrument are not transferred to indorsee unless after indorsement, it is delivered.

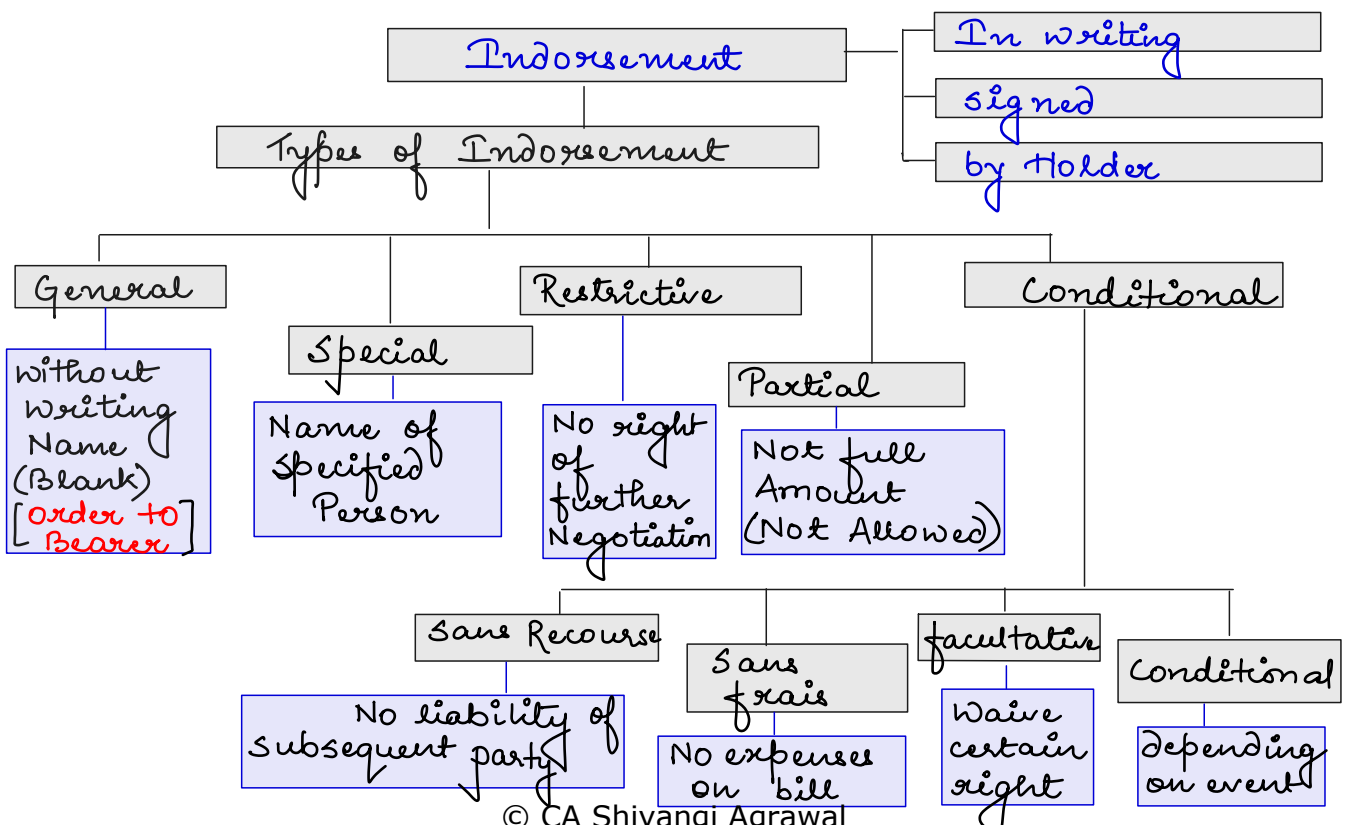

Negotiation Back :-

When Indorser after negotiating becomes holder again
→ None of the intermediate Holder/endorser is liable to Holder (except for Sans recourse Indorsement)

Conversion of Blank Indorsement into full

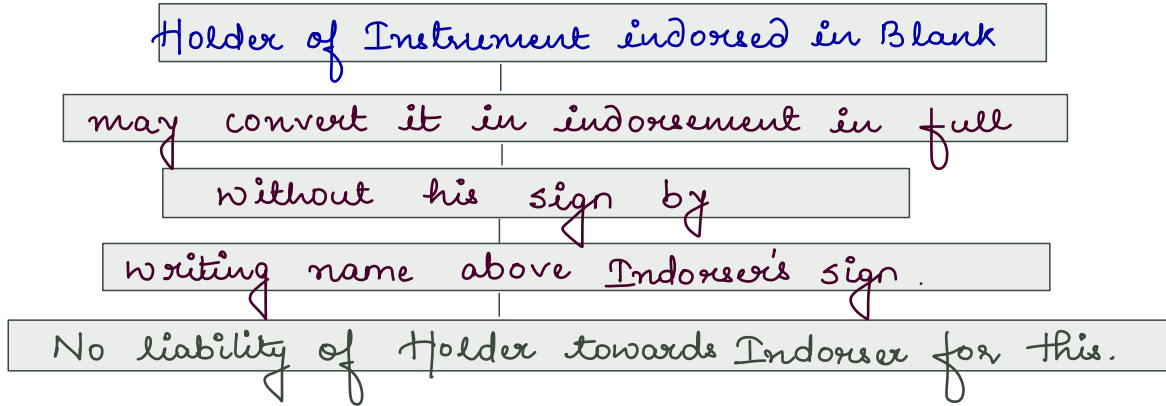

Instrument obtained by Unlawful means Section 58

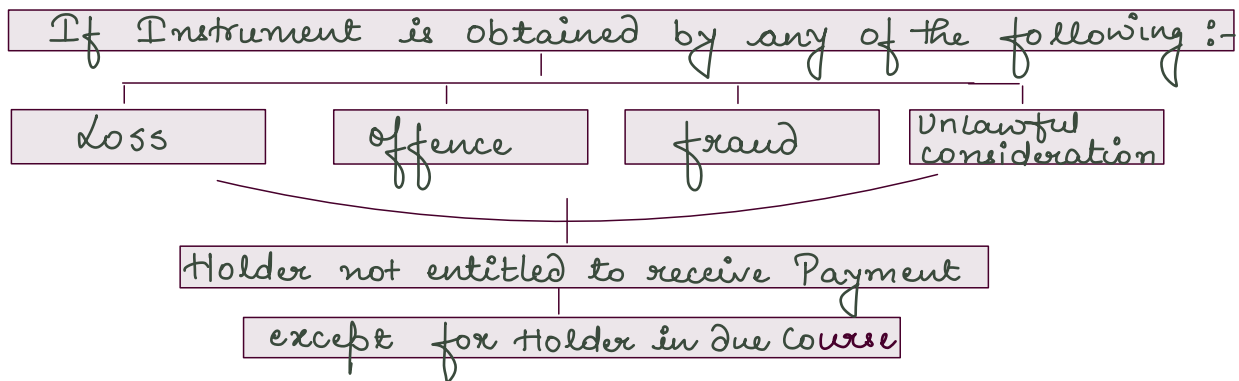

Can Instrument be negotiated after maturity?

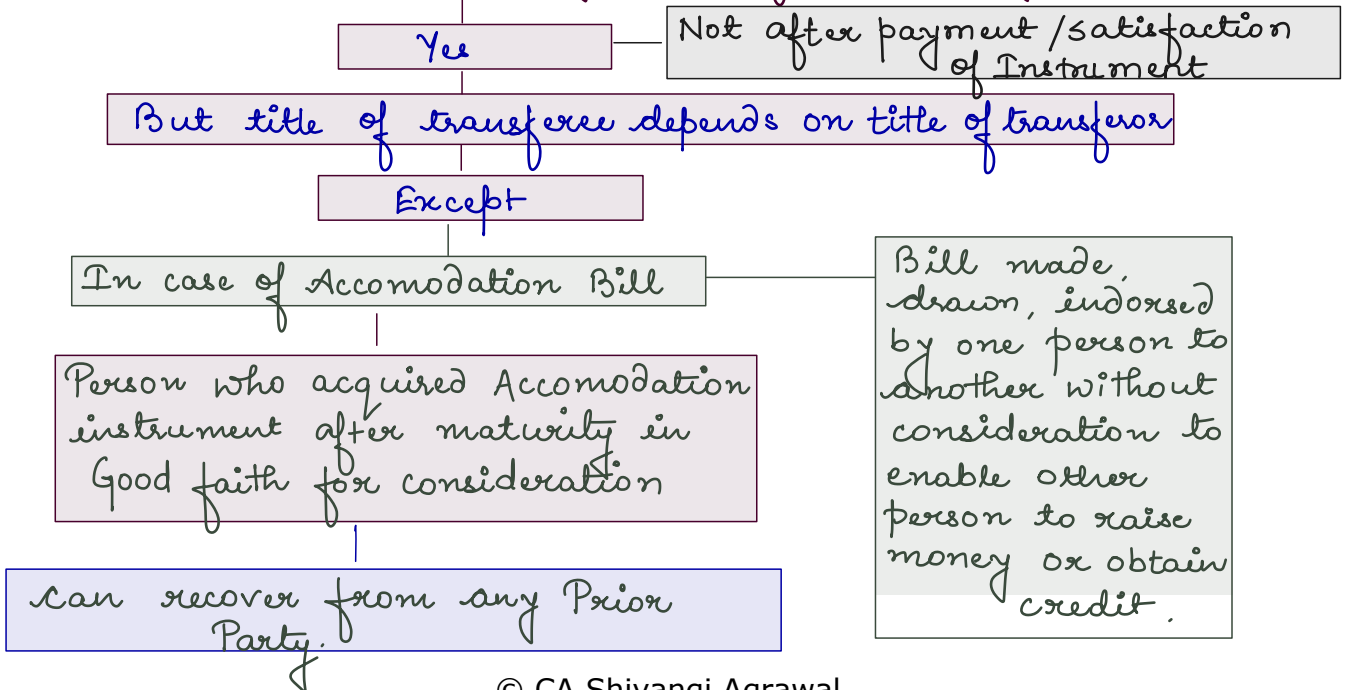

Holder

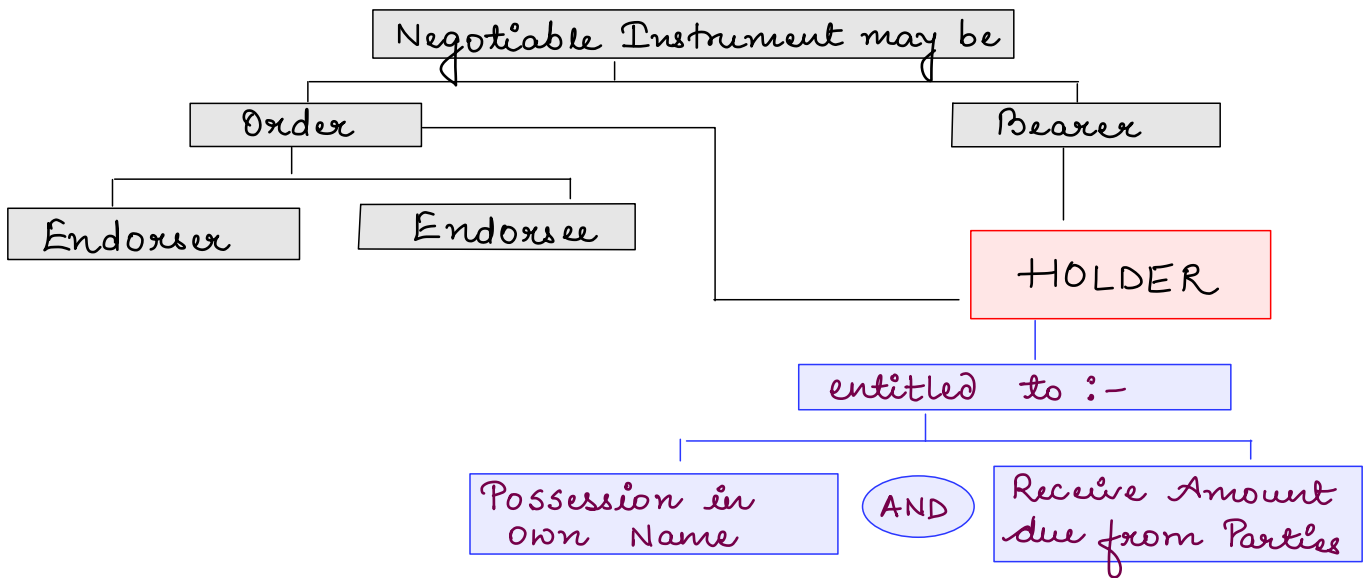

A person in possession without having right to possess is not a HOLDER.

Negotiable Instrument without consideration

Section 43

A negotiable instrument without consideration

creates no obligation b/w Parties

Except to HDC who acquires in Good faith

Exceptions :-
Accommodation Bill
Not exceeding Performance Value

Partial failure (Sec. 44)

Claim of holder in immediate relation shall be proportionately reduced.

failure Not consisting of Money (Sec. 45)

Claim of holder in immediate relation shall be proportionately reduced.

Holder's right to Duplicate Bill [Sec. 45A]

B/E lost before it is due

Holder

may apply to Drawer

Drawer gives

to get Duplicate Bill

Drawer refuses

after security/Indemnity

Can be compelled to do so.

Holder for Value

B/w Holder & HDC. Gets instrument for consideration after maturity

Holder in Due Course (Sec. 9)

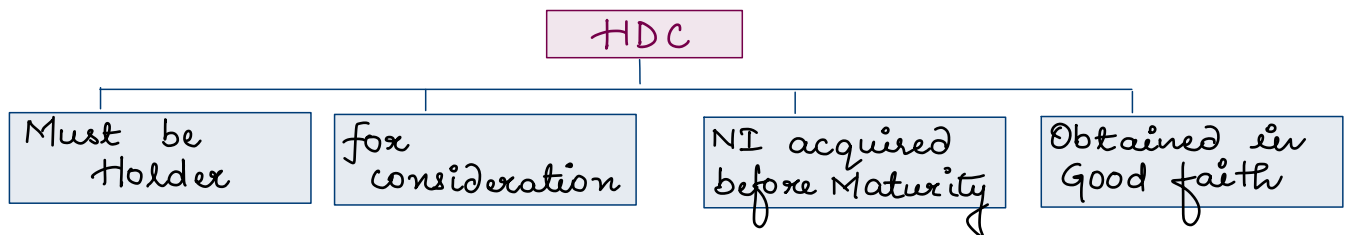

He must be possessor in case of Bearer Instrument.
He must be Payee or Endorsee in case of order Instrument.

HDC is entitled to following Privileges :-

can claim full stamp value of the Instrument (sec. 20)

can make the party liable even if the Bill is fictitious (sec. 42)

Even if delivery depends upon happening of some event, HDC gets good title.

HDC acquires good title even if Instrument was obtained by Unlawful means / consideration (sec 58)

No person can deny original validity of instrument to HDC.

No person shall be permitted to deny payee's capacity.

All subsequent parties acquiring title from HDC gets good title. (Sec. 53)

HDC gets a better title than that of its transferor. (Sec. 36) → can sue all Prior Parties

Payment in Due Course [Sec. 10]

As per apparent Tenor

In good faith

Without Negligence

in possession of Instrument

in Money only.

Presentment of Negotiable Instruments

Presentment for Acceptance

Presentment for Payment

Bill of Exchange

Negotiable Instruments

A bill payable after sight
A bill in which condition for acceptance needed
requires Acceptance

Rules for Presentment for acceptance

By whom?

To whom?

Time and Place

Max Time Allowed

When Not required

By Holder
or
someone on
behalf of
Holder

Drawee

48 Hours to consider
whether he will
or not accept
the bill

If specified

Not specified

As specified

Reasonable
Place and
time.

Drawee not found.
Drawee not dead or
insolvent.
Drawee is fictitious
Drawee is incompetent
to contract.

If Holder allows more time, all previous parties not consenting are discharged.

Default in Presentment :-

Dishonour due Non-acceptance. [Sec. 91]
No liability of drawee under Bill.
No privity of contract
No party liable.

Promissory Note after sight must be presented to maker for sight

Presentment for Payment

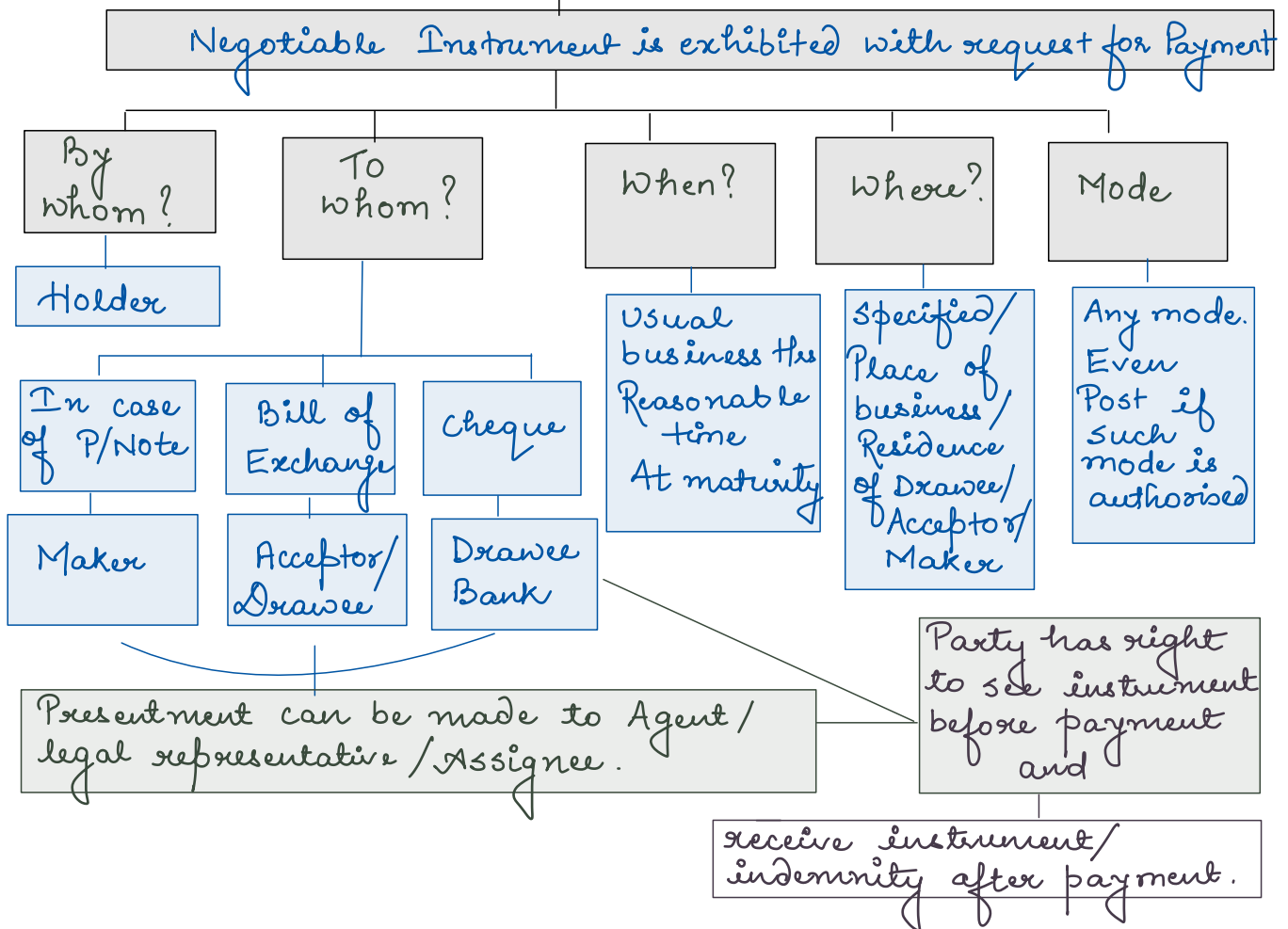

When Presentment not necessary?

Maker/Acceptor prevents presentment - Cheque must be presented to charge Drawer
 Payable at a place where no one found.
 If with knowledge of Non-presentment, party makes part-payment.
 Waives right.

Interest if not agreed for belated payment shall be @ 18% p.a.

Acceptance in fictitious Name (Sec. 42)

Bill drawn in fictitious name of Drawer but signed on Bill & Indorsee in same writing
 ↓
 Bill Accepted
 ↓
 Negotiated to HDC
 ↓
 Acceptor liable towards HDC.
 (can't deny)

Acceptance for Honour :-

Bill Noted for Non-Acceptance
 ↓
 For better security
 ↓
 Person not being party to Bill
 ↓
 with consent of Holder
 ↓
 Accept by writing
 ↓
 for honour of any party thereto.

Dishonour of Instruments

By Non-Acceptance if

Bill

Drawee doesn't accept within 48 Hrs
Drawee refuses to accept
Qualified acceptance & Holder doesn't give consent
Drawee incompetent/fictitious/Not found
One of the drawee doesn't accept

Holder gets immediate right to sue all prior parties

P/Note or cheque can't be dishonoured due to Non-acceptance as it does not require acceptance

Bill P/Note Cheque

By Non-payment if

Instrument remains unpaid after maturity

If default in payment is made by -

Maker in case of P/Note

Acceptor/Drawee in case of Bill of Exchange

Drawee in case of cheque

To make all prior Parties, Notice of Dishonour to be given

by HOLDER

to all prior parties (Except Sans recourse Indorser)

Notice must disclose fact of dishonour

How?

Oral/written
Same rules as of Presentment

can be given by any Party other than Holder

Party who doesn't receive such notice is discharged

Notice not necessary if :- (Sec. 98)

dispensed by Party
Party not found

Countersigned Payment
couldn't give notice without own fault.

Noting :- Recording of fact of Dishonour by Notary Public.
Protesting :- Certificate attesting dishonour based upon Noting.

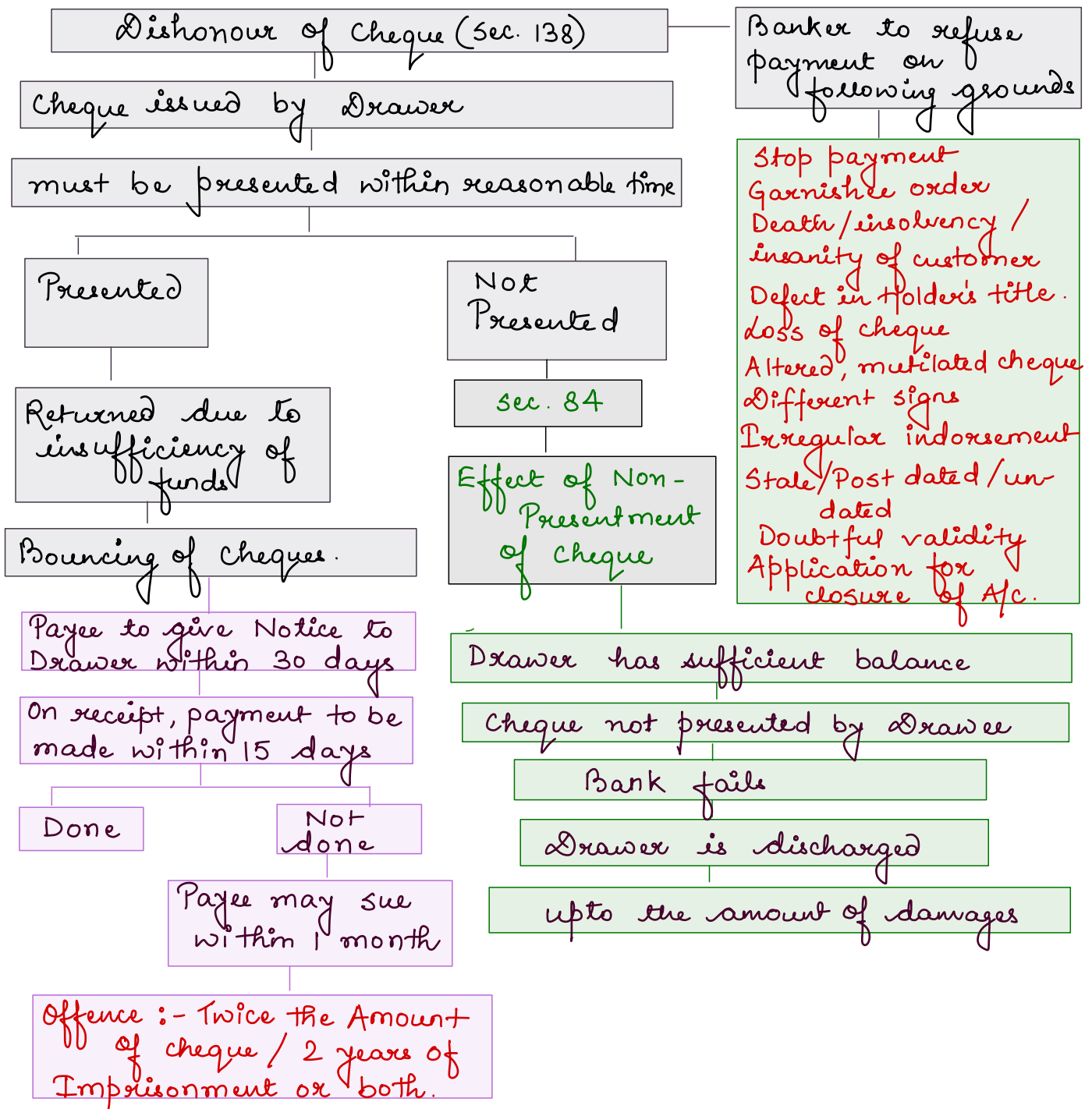

Offences by Companies

Offence committed by company & proved that offence committed with consent of or attributable to negligence on Officer in charge, they shall be held liable.

Cognizance of Offences

Complaint made to court in writing
by Payee or Holder in due course
within 1 month of cause of action

It shall be tried only by a court —

If cheque delivered for collection through Account

Where branch of Payee (in which he maintains A/c) is situated

If cheque presented otherwise through Account

Branch of Drawee Bank (where Drawer maintains A/c) is situated.

Every offence punishable is compoundable.

Material Alteration

which alters character (legal effect) or rights & liabilities of instrument (change of Date, time, place, Amount)

Allowed :-
Crossing conversion of Blank indorsement to full Bearer into order.

Effect (sec. 87)

Instrument shall be void.

Parties not consenting are discharged.

Protection shall be offered to person who makes payment on altered instrument which is not apparent.

Discharge

of Negotiable Instruments

of Party

Discharge of all Parties

Discharge of 1/more party

	of Instrument	of Party
Payment	Party primarily liable makes payment ↓ All parties discharged	Any party makes payment ↓ subsequent parties discharged

Cancellation	Holder cancels name of Party primarily liable ↓ All parties discharged	Holder cancels name of one of the party ↓ subsequent parties discharged
Release	Holder renounces right against Party primarily liable ↓ All parties discharged	Holder renounces right against any party ↓ subsequent parties discharged
Negotiation Back	Party primarily liable becomes Holder of Negotiable Instrument ↓ All Parties discharged	Party already liable becomes Holder of instrument ↓ Subsequent parties discharged.
Lapse of Time	Instrument discharged on becoming Time Barred.	
Allowing drawer more than 48 Hours		Parties not consenting discharged
Qualified Acceptance		Parties not consenting discharged
Material Alteration		Parties not consenting discharged
No notice of dishonour		Party not receiving Notice of dishonour discharged
Insolvency		Party insolvent discharged.

Indian Contract Act, 1872

Special Contracts

Contract of Bailment (Chapter - IX - Sections 148 to 181)

Delivery of goods by one person to another for some Purpose

can be
Actual
Symbolic
Constructive

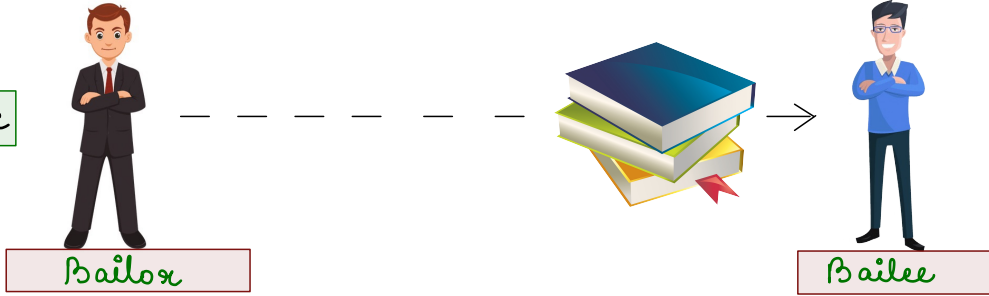

When purpose accomplished be returned / disposed according to directions of person delivering them.

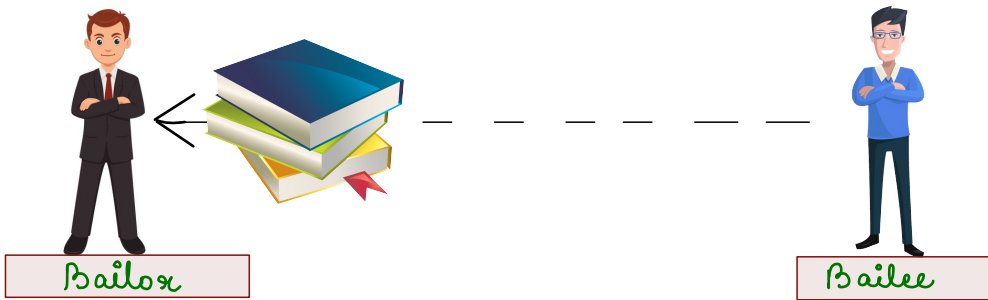

This is a contract of bailment

which confers certain rights and duties upon Bailor and Bailee

in the following cases

Essentials
Only for movable goods (Not money)
Possession changes
must return same goods
Delivery essential
can be implied by Law also

Gratuitous Bailment

Non-Gratuitous Bailment

No charges or reward

for some reward
↓
Hire charges paid by bailee
OR
Custody charges paid by bailor

for the benefit of Bailor

for the benefit of Bailee

Duties of Bailor

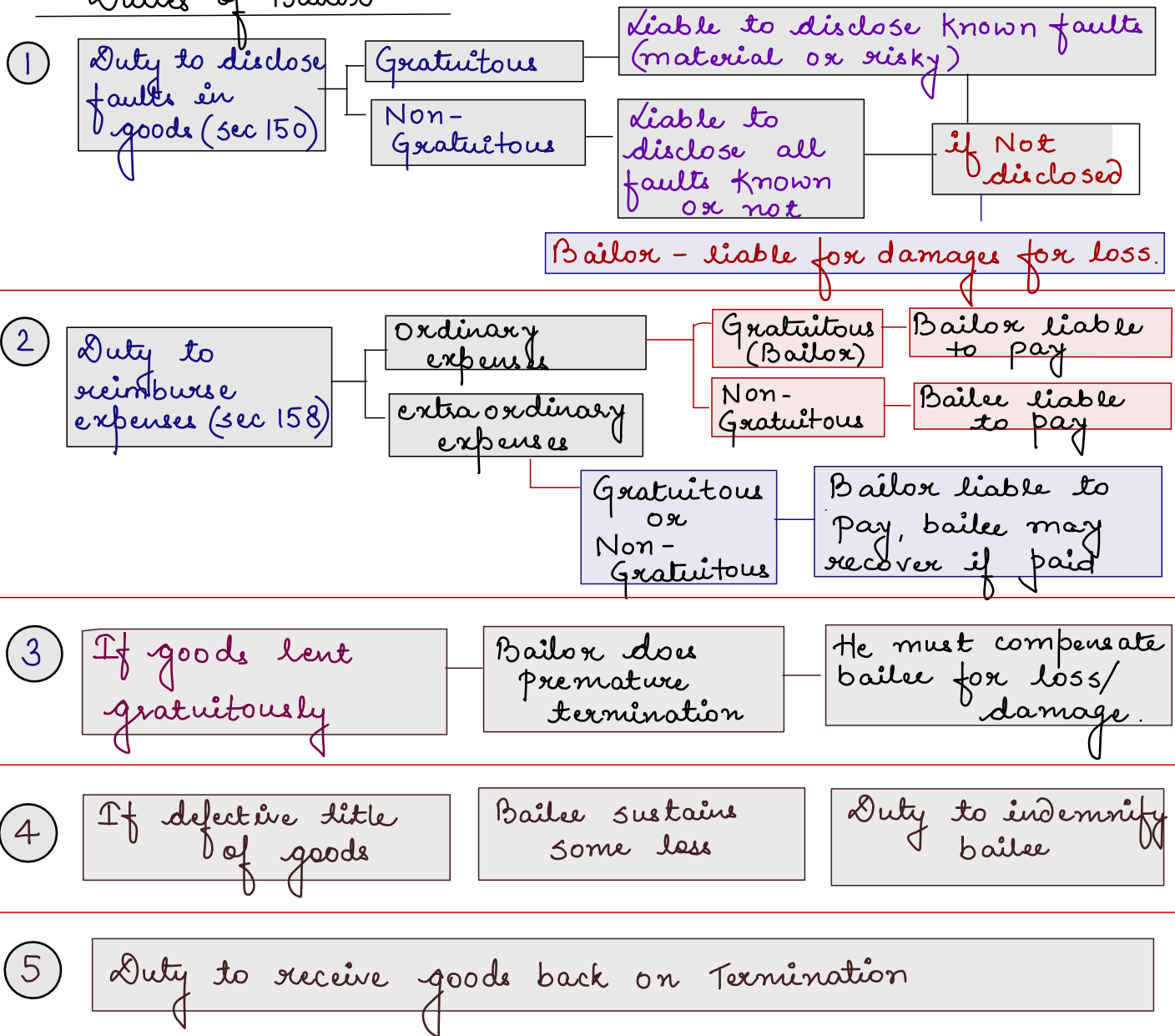

Duties of Bailee

To take reasonable care of goods. Not liable for loss if not negligent / loss by unavoidable reasons

Not to make inconsistent / unauthorised use. If does, bailment → voidable at option of bailor

AND

Bailee liable for all loss

Not to mix goods

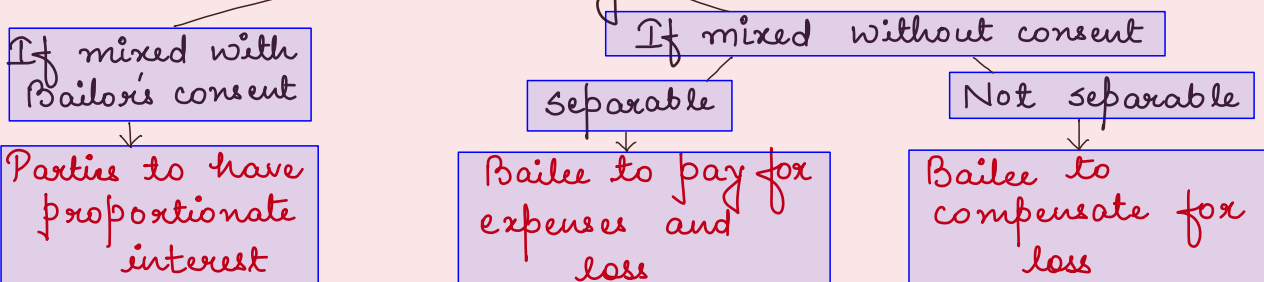

Bailee must return goods on expiry of time or when purpose accomplished

if Not

Goods at risk of bailee

Bailee liable for any loss/damage even if without Negligence

Bailee must return to bailor any accretion to goods bailed

Bailee has no right to allege that bailor had no authority to bail the goods.

Rights of Bailor

To terminate bailment if bailee does any act inconsistent with terms.

Demand goods back if lent gratuitously for specific period but bailor shall indemnify if any loss.

Right to sue 3rd party who does any damage or deprives from using goods.

Right to sue bailee to enforce his duties.

Right to claim damages from unauthorised use of goods
accretion to goods
damages from mixing of goods.

Rights of Bailee

get the goods returned.

To claim indemnification in case of defective title of goods

To receive compensation in case faults not disclosed by bailor

To recover ordinary expenses in case of gratuitous bailment for the benefit of bailor and extraordinary expenses

To file suit for deciding title and also against wrongdoer

To exercise right of lien

Right of lien of Bailee

General lien

Right to retain property of another for general of Balance of Account

Particular lien

Right to retain goods on which skill/labour exercised.

Finder of Goods

He has same rights and duties as of bailee

Also entitled to following rights

Right to recover expenses

Sec. 168

Right to recover specific reward

Right of sale of goods (Sec. 169)

If

with no right to sue for same but right of lien

with Right to sue and right of lien

True owner can't be found or He refuses to pay lawful expenses and

Goods are of perishable nature OR lawful charges amount to $\frac{2}{3}$ rd value of goods.

Contract of Pledge

Bailment of goods as security for Payment of debt etc.

Rights of Pawnee

Retain goods till debt is paid
Retain goods till subsequent advances paid off.
Receive extraordinary expenses for preservation
sell goods if default.
sue Pawnor

Duties of Pawnee

Take reasonable care of goods
NO unauthorised use
Return goods
Not to mix goods
return increase in goods.

Rights of Pawnor

recover goods back
Enforce Pawnee's duties
Receive increase in goods
get the goods taken care of
receive notice of sale of goods.

Duties of Pawnor

Pay Debt
Pay deficit on sale
Pay extra ordinary expenses for preservation
Disclose faults
Indemnify Pawnee for defect in title

Contract of Indemnity



If one Party promises to save other from loss caused to him by conduct of Promisor/Any person

Parties

Indemnifier

Indemnity Holder/Indemnified

who Promises to save

who is promised to be saved

Indemnity can be expressed / implied

Rights of Indemnity Holder (Sec.125)

Indemnity Holder has right to recover all damages which he is compelled to pay in any suit in respect of matter covered.

Right to recover sums paid under compromise if -
Indemnifier authorised
OR
Indemnified did not contravene orders of indemnified and acted in Prudent manner

Right to recover costs in bringing/defending suit if -
Indemnifier authorised OR
Indemnified did not contravene orders of indemnified and acted in Prudent manner

Contract of Guarantee

To perform a promise or discharge liability of 3rd person in case of his default

Parties

Surety

Person who gives guarantee

Principal Debtor

Person in respect of whose default guarantee is given

Creditor

Person to whom guarantee is given

Essentials

All essentials of a valid contract

Consideration according to Sec. 127.

Capacity to contract [Principal Debtor may be incompetent to contract]

Oral/written

Debt legally enforceable and not time barred.

Primary liability of Principal Debtor

Secondary liability of surety which arises only when principal debtor makes default.

No misrepresentation

Not valid if co-surety does not join.

Any guarantee obtained by misrepresentation / concealing material circumstances is invalid (Sec. 142, 143)

Consideration for Surety? (Sec. 127)
Anything done / Promise made for benefit of Principal Debtor is sufficient

Types of Guarantee

Specific

which is fixed and particular

Continuing

which extends to a series of transactions.

Revocation

Anytime by giving Notice only for future transactions
Also by death of surety.

Surety's Liability [Sec. 128]

is co-extensive with that of Debtor

may be

arises on default by Principal Debtor

Creditor may sue Surety directly without giving Notice / filing suit against Principal Debtor

limited
continuous
conditional

Rights of Surety

Rights against Principal Debtor

Right of indemnity
entitled to claim all sums rightfully paid

Right of subrogation
entitled to all the rights which creditor could claim against Debtor

Right against Creditor

Right to claim Securities
claim securities which creditor had. If returned, discharged to such extent.

Right of set-off
Amount recoverable by Principal Debtor / Surety may be claimed as deduction.

Right against co-sureties.

Right to contribution
contribute equally unless some proportion fixed subject to maximum limit if any

Right to share benefit of Securities
if one co-surety receives security, others also entitled to share benefit.

Discharge of Surety

Notice of Revocation (Sec 130) -
Specific - if liability of Principal debtor not accrued
Continuing - only in respect of future transactions

Death of Surety (Sec. 131) - continuing guarantee -
Automatically revoked for future transactions.

Variance in Terms (Sec. 133)

If variation in terms / conditions of contract without surety's consent, discharged for transactions after variation

Release of Principal Debtor

Novation or

Any act by creditor resulting in discharge of Principal debtor

composition with Principal Debtor without surety's consent

Creditor enters into a contract with Debtor not to sue him

Creditor extends time without surety's consent

Surety not discharged if -
contract of extension of time is made with Third Party
Mere forbearance by Creditor to sue Principal Debtor

Loss of Security by Creditor (sec. 141) - Surety discharged to such extent of loss.

Surety's eventual remedy impaired (sec. 139) - Surety discharged if Creditor does/omits resulting in such impairment.

Invalidation - if Misrepresentation, concealment, Non-joining of co-sureties (sec. 142, 143, 144)

Contract of Agency

No definition - Rule - He who acts through Agent is acting himself

How to identify Agency?

Through Test

Can a Person bind his Principal

Can He establish Privity of Contract between Principal & Third Party

Yes

then Agency

Parties

Agent

Person employed to do any act
Any Person (even Minor/Unsound mind) can be an Agent

Principal

Person for whom act is done
Only major and sound Person can be Principal

No consideration is necessary for creating Agency (Sec. 185)

Modes of Creation of Agency

Express Agreement

It may be oral/written but expressed

Through conduct and behaviour of Parties

Implied Agreement

By Estoppel

Representation that certain person is Agent which 3rd party believes to be true.

Actual Necessity
No communication
Bonafide act to protect interest of Principal
Reasonable Care

Operation of Law

Necessity

Law treats a person as Agent
eg. Partnership

Express / Implied full Knowledge
whole transaction
No injury to 3rd Party
Reasonable Time
Communication
Lawful Acts.

Ratification

Approval of act of Pretended agent by alleged Principal.

Extent of Agent's Authority

In normal circumstances

do all lawful acts necessary in discharge of functions

In emergency

All acts that man of ordinary prudence would do to prevent losses

In possession of goods
No contact
Bonafide act
Actual necessity
Reasonable.

Duties of an Agent

conduct business in accordance with directions by Principal

Work with reasonable diligence, care and skill.

Not to deal on his own account without knowledge of Principal.

To render Proper accounts to Principal

Not to make secret Profit

If done

Principal may repudiate contract & claim benefits from Agent.

Remit all sums received in Principal's account

Not to delegate Authority or appoint sub-Agent

Not to use info obtained during course against Principal

Rights of an Agent

Retain money out of sums received in Agency for advance made/expenses incurred and remuneration (Sec. 217)

To receive agreed remuneration
If not agreed - usual and customary

Lien on Principal's goods, property, papers until remuneration received

Not entitled if guilty of misconduct

Lost if Agent waives his right or possession lost

To be indemnified by Principal

To claim compensation for injury caused because of Principal's neglect or want of skill

against consequences of lawful acts done in authority

acts done in good faith that caused injury to 3rd party

If act is criminal, Principal not liable to Agent.

Agency coupled with Interest (Sec. 202)

If Agency created for securing some benefit to agent over and above remuneration, it is coupled with interest

Such interest must exist at time of creation

This type of Agency can't be terminated to prejudice of such interest

or even on death/insanity of Principal

This is irrevocable Agency

Principal's liability for Agent's acts to Third Parties

When Agent acts

within the scope of Authority

Principal is liable

more than given authority

What he does beyond

can be separated

Principal bound for part/act which is within authority

can't be separated

Principal not bound for whole

Principal bound if he induced 3rd party to believe about agent acting within Authority.

Notice to agent deemed as Notice to Principal
Misrepresentation by agent deemed as misrepresentation by Principal.

Agent's liability

Agent is not personally liable for contracts entered by it on Principal's behalf. However, there are certain exceptions.

Cases where Agent is Personally liable-

- In case of foreign Principal
- When Agent does not disclose name of Principal
- Non-existent Principal
- Pretended Agent
- When Agent exceeds Authority
- expressly provided in contract
- Signs Negotiable instrument in own name

Rights of Third Parties

Third party doesn't know about Principal
Still has rights against Principal
Also, may refuse contract on knowing about Principal

Where Agent Personally liable
↓
3rd party may make Agent/
Principal liable

Third party doesn't know about Principal
↓
Principal wants Performance
subject to rights and duties (b/w Agent & 3rd party)

Limited right if third Party induced Agent / Principal to act on belief that Principal or agent will be exclusively liable.

Termination of Agency

By Revocation :-

Authority may be revoked anytime before authority exercised by Principal (Not allowed if Partly exercised)

May be express or implied.

When Agency is coupled with interest, Principal can't revoke agency to prejudice of such interest

If revoked before period fixed - Principal must make compensation

Revocation after giving reasonable Notice

By Agent renouncing business of Agency :-

Just like Principal may revoke, Agent may renounce.

Compensate for Premature termination

Reasonable Notice

Completion of business

Death/insanity of Principal/Agent

Insolvency of Principal

Expiration of Period of Agency

Mutual Agreement to terminate Agency.

Destruction of Subject Matter.

Sub-Agent

Person employed under the original agent

If Properly
Appointed

Principal bound to 3rd parties
Agent responsible to principal
for acts of sub-agent
Sub-Agent responsible to
Agent for his acts.
Sub-Agent not responsible
to Principal except in
case of fraud

If not properly
appointed.

Principal not bound to 3rd Parties
Agent responsible to Principal
and 3rd parties for acts of
sub-agent
Sub-Agent responsible to
Agent for acts done by him
Sub-Agent is not responsible
to Principal.

Substituted Agents

Person appointed by Agent to act as Agent for Principal

He is just like an agent

Due care by Agent in selecting such Person